

SMIPS Processor Specification

6.375 Complex Digital Systems

March 21, 2006

SMIPS is the version of the MIPS instruction set architecture (ISA) we'll be using for the processors we implement in 6.884. SMIPS stands for Simple MIPS since it is actually a subset of the full MIPS ISA. The MIPS architecture was one of the first commercial RISC (reduced instruction set computer) processors, and grew out of the earlier MIPS research project at Stanford University. MIPS stood for "Microprocessor without Interlocking Pipeline Stages" and the goal was to simplify the machine pipeline by requiring the compiler to schedule around pipeline hazards including a branch delay slot and a load delay slot. Today, MIPS CPUs are used in a wide range of devices: Casio builds handheld PDAs using MIPS CPUs, Sony uses two MIPS CPUs in the Playstation-2, many Cisco internet routers contain MIPS CPUs, and Silicon Graphics makes Origin supercomputers containing up to 512 MIPS processors sharing a common memory. MIPS implementations probably span the widest range for any commercial ISA, from simple single-issue in-order pipelines to quad-issue out-of-order superscalar processors.

There are several variants of the MIPS ISA. The ISA has evolved from the original 32-bit MIPS-I architecture used in the MIPS R2000 processor which appeared in 1986. The MIPS-II architecture added a few more instructions while retaining a 32-bit address space. The MIPS-II architecture also added hardware interlocks for the load delay slot. In practice, compilers couldn't fill enough of the load delay slots with useful work and the NOPs in the load delay slots wasted instruction cache space. (Removing the branch delay slots might also have been a good idea, but would have required a second set of branch instruction encodings to remain backwards compatible.) The MIPS-III architecture debuted with the MIPS R4000 processor, and this extended the address space to 64 bits while leaving the original 32-bit architecture as a proper subset. The MIPS-IV architecture was developed by Silicon Graphics to add many enhancements for floating-point computations and appeared first in the MIPS R8000 and later in the MIPS R10000. Over the course of time, the MIPS architecture has been widely extended, occasionally in non-compatible ways, by different processor implementors. MIPS Technologies, who now own the architecture, are trying to rationalize the architecture into two broad groupings: MIPS32 is the 32-bit address space version, MIPS64 is the 64-bit address space version. There is also MIPS16, which is a compact encoding of MIPS32 that only uses 16 bits for each instruction. You can find a complete description of the MIPS instruction set at the MIPS Technologies web site [2] or in the book by Kane and Heinrich [3]. The book by Sweetman also explains MIPS programming [4]. Another source of MIPS details and implementation ideas is "Computer Organization and Design: The Hardware/Software Interface" [1].

The SMIPS CPU implements a subset of the MIPS32 ISA. It does not include floating point instructions, trap instructions, misaligned load/stores, branch and link instructions, or branch likely instructions. There are three SMIPS variants which are discussed in more detail at the end of this document. SMIPsv1 has only five instructions and it is mainly used as a toy ISA for instructional SMIPsv2 includes the basic integer, memory, and control instructions. It excludes multiply instructions, divide instructions, byte/halfword loads/stores, and instructions which cause arithmetic overflows. Neither SMIPsv1 or SMIPsv2 support exceptions, interrupts, or most of the system coprocessor. SMIPsv3 is the full SMIPS ISA and includes everything described in this document.

1 Basic Architecture

Figure 1 shows the programmer visible state in the CPU. There are 31 general purpose 32-bit registers `r1`–`r31`. Register `r0` is hardwired to the constant 0. There are three special registers defined in the architecture: two registers `hi` and `lo` are used to hold the results of integer multiplies and divides, and the program counter `pc` holds the address of the instruction to be executed next. These special registers are used or modified implicitly by certain instructions.

SMIPS differs significantly from the MIPS32 ISA in one very important respect. SMIPS does *not* have a programmer-visible branch delay slot. Although this slightly complicates the control logic required in simple SMIPS pipelines, it greatly simplifies the design of more sophisticated out-of-order and superscalar processors. As in MIPS32, Loads are fully interlocked and thus there is no programmer-visible load delay slot.

Multiply instructions perform 32-bit \times 32-bit \rightarrow 64-bit signed or unsigned integer multiplies placing the result in the `hi` and `lo` registers. Divide instructions perform a 32-bit/32-bit signed or unsigned divide returning both a 32-bit integer quotient and a 32-bit remainder. Integer multiplies and divides can proceed in parallel with other instructions provided the `hi` and `lo` registers are not read.

The SMIPS CPU has two operating modes: *user* mode and *kernel* mode. The current operating mode is stored in the KUC bit in the system coprocessor (COP0) `status` register. The CPU normally operates in user mode until an exception forces a switch into kernel mode. The CPU will then normally execute an exception handler in kernel mode before executing a Return From Exception (ERET) instruction to return to user mode.

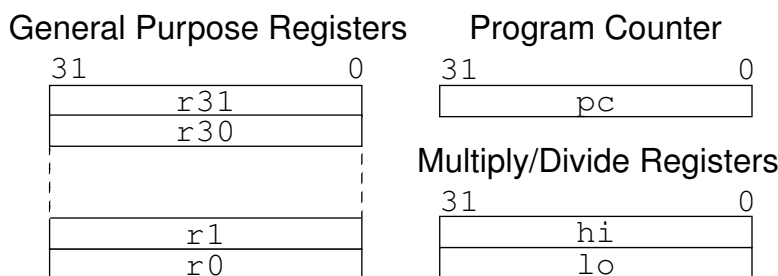

Figure 1: SMIPS CPU registers

2 System Control Coprocessor (CP0)

The SMIPS system control coprocessor contains a number of registers used for exception handling, communication with a test rig, and the counter/timer. These registers are read and written using the MIPS standard MFC0 and MTC0 instructions respectively. User mode can access the system control coprocessor only if the `cu[0]` bit is set in the `status` register. Kernel mode can always access CP0, regardless of the setting of the `cu[0]` bit. CP0 control registers are listed in Table 1.

Number	Register	Description
0–7		<i>unused.</i>
8	<code>badvaddr</code>	Bad virtual address.
9	<code>count</code>	Counter/timer register.
10		<i>unused.</i>
11	<code>compare</code>	Timer compare register.
12	<code>status</code>	Status register.
13	<code>cause</code>	Cause of last exception.
14	<code>epc</code>	Exception program counter.
15–19		<i>unused.</i>
20	<code>fromhost</code>	Test input register.
21	<code>tohost</code>	Test output register.
22–31		<i>unused.</i>

Table 1: CP0 control registers.

2.1 Test Communication Registers

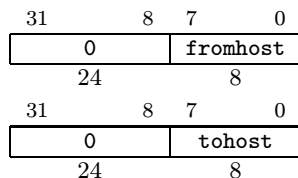

Figure 2: Fromhost and Tohost Register Formats.

There are two registers used for communicating and synchronizing with an external host test system. Typically, these will be accessed over a scan chain. The `fromhost` register is an 8-bit read only register that contains a value written by the host system. The `tohost` register is an 8-bit read/write register that contains a value that can be read back by the host system. The `tohost` register is cleared by reset to simplify synchronization with the host test rig. Their format is shown in Figure 2.

2.2 Counter/Timer Registers

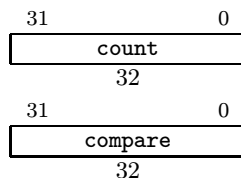

Figure 3: Count and Compare Registers.

SMIPS includes a counter/timer facility provided by the two coprocessor 0 registers `count` and `compare`. Both registers are 32 bits wide and are both readable and writeable. Their format is shown in Figure 3.

The `count` register contains a value that increments once every clock cycle. The `count` register is normally only written for initialization and test purposes. A timer interrupt is flagged in `ip7` in the `cause` register when the `count` register reaches the same value as the `compare` register. The interrupt will only be taken if both `im7` and `iec` in the `status` register are set. The timer interrupt flag in `ip7` can only be cleared by writing the `compare` register. The `compare` register is usually only read for test purposes.

2.3 Exception Processing Registers

A number of CP0 registers are used for exception processing.

2.3.1 Status Register

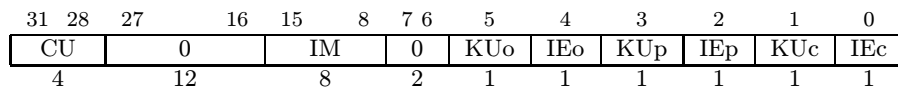

Figure 4: Status Register Format

The `status` register is a 32-bit read/write register formatted as shown in Figure 4. The `status` register keeps track of the processor's current operating state.

The CU field has a single bit for each coprocessor indicating if that coprocessor is usable. Bits 29–31, corresponding to coprocessor's 1, 2, and 3, are permanently wired to 0 as these coprocessors are not available in SMIPS. Coprocessor 0 is always accessible in kernel mode regardless of the setting of bit 28 of the `status` register.

The IM field contains interrupt mask bits. Timer interrupts are disabled by clearing `im7` in bit 15. External interrupts are disabled by clearing `im6` in bit 14. The other bits within the IM field are not used on SMIPS and should be written with zeros. Table 4 includes a listing of interrupt bit positions and descriptions.

The KUC/IEC/KUP/IEP/KUO/IEO bits form a three level stack holding the operating mode (kernel=0/user=1) and global interrupt enable (disabled=0/enabled=1) for the current state, and the two states before the two previous exceptions.

When an exception is taken, the stack is shifted left 2 bits and zero is written into KUC and IEC. When a Restore From Exception (RFE) instruction is executed, the stack is shifted right 2 bits, and the values in KUO/IEO are unchanged.

2.3.2 Cause Register

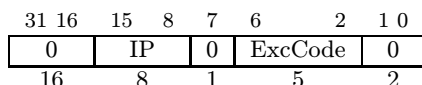

Figure 5: Cause Register Format

The **cause** register is a 32-bit register formatted as shown in Figure 5. The **cause** register contains information about the type of the last exception and is read only.

The ExcCode field contains an exception type code. The values for ExcCode are listed in Table 2. The ExcCode field will typically be masked off and used to index into a table of software exception handlers.

ExcCode	Mnemonic	Description
0	Hint	External interrupt
2	Tint	Timer interrupt
4	AdEL	Address or misalignment error on load
5	AdES	Address or misalignment error on store
6	AdEF	Address or misalignment error on fetch
8	Sys	Syscall exception
9	Bp	Breakpoint exception
10	RI	Reserved instruction exception
12	Ov	Arithmetic Overflow

Table 2: Exception Types.

If the Branch Delay bit (BD) is set, the instruction that caused the exception was executing in a branch delay slot and `epc` points to the immediately preceding branch instruction. Otherwise,

The IP field indicates which interrupts are pending. Field `ip7` in bit 15 flags a timer interrupt. Field `ip6` in bit 14 flags an external interrupt from the host test setup. The other IP bits are unused in SMIPS and should be ignored when read. Table 4 includes a listing of interrupt bit positions and descriptions.

2.3.3 Exception Program Counter

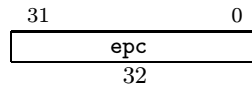

Figure 6: EPC Register.

`Epc` is a 32-bit read only register formatted as shown in Figure 6. When an exception occurs, `epc` is written with the virtual address of the instruction that caused the exception.

2.3.4 Bad Virtual Address

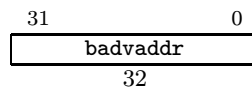

Figure 7: Badvaddr Register.

`Badvaddr` is a 32-bit read only register formatted as shown in Figure 7. When a memory address error generates an AdEL or AdES exception, `badvaddr` is written with the faulting virtual address. The value in `badvaddr` is undefined for other exceptions.

3 Addressing and Memory Protection

SMIPS has a full 32-bit virtual address space with a full 32-bit physical address space. Sub-word data addressing is big-endian on SMIPS.

The virtual address space is split into two 2 GB segments, a kernel only segment (*kseg*) from 0x0000_0000 to 0x7fff_ffff, and a kernel and user segment (*kuseg*) from 0x8000_0000 to 0xffff_ffff. The segments are shown in Figure 8.

In kernel mode, the processor can access any address in the entire 4 GB virtual address space. In user mode, instruction fetches or scalar data accesses to the *kseg* segment are illegal and cause a synchronous exception. The AdEF exception is generated for an illegal instruction fetch, and AdEL and AdES exceptions are generated for illegal loads and stores respectively. For faulting stores, no data memory will be written at the faulting address.

There is no memory translation hardware on SMIPS. Virtual addresses are directly used as physical addresses in the external memory system. The memory controller simply ignores unused high order address bits, in which case each physical memory address will be shadowed multiple times in the virtual address space.

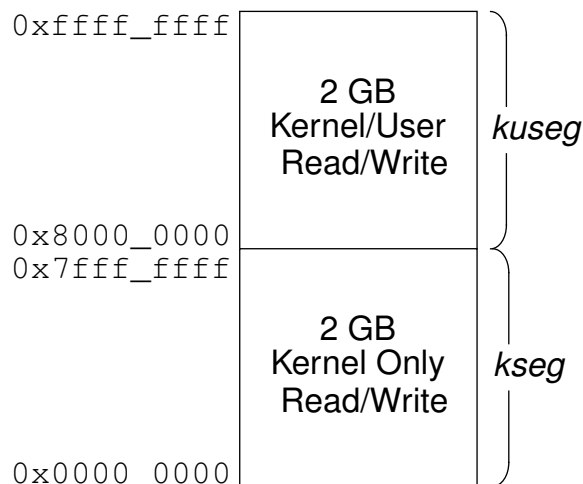

Figure 8: SMIPS virtual address space

4 Reset, Interrupt, and Exception Processing

There are three possible sources of disruption to normal program flow: reset, interrupts (asynchronous exceptions), and synchronous exceptions. Reset and interrupts occur asynchronously to the executing program and can be considered to occur *between* instructions. Synchronous exceptions occur *during* execution of a particular instruction.

If more than one of these classes of event occurs on a given cycle, reset has highest priority, and all interrupts have priority over all synchronous exceptions. The tables below show the priorities of different types of interrupt and synchronous exception.

The flow of control is transferred to one of two locations as shown in Table 3. Reset has a separate vector from all other exceptions and interrupts.

Vector Address	Cause
0x0000_1000	Reset
0x0000_1100	Exceptions and internal interrupts.

Table 3: SMIPS Reset, Exception, and Interrupt Vectors.

4.1 Reset

When the external reset is deasserted, the PC is reset to 0x0000_1000, with `kuc` set to 0, and `iecr` set to 0. The effect is to start execution at the reset vector in kernel mode with interrupts disabled. The `tohost` register is also set to zero to allow synchronization with the host system. All other state is undefined.

A typical reset sequence is shown in Figure 9.

```

reset_vector:
    mtc0 zero, $9    # Initialize counter.
    mtc0 zero, $11   # Clear any timer interrupt in compare.

    # Initialize status with desired CU, IM, and KU/IE fields.
    li k0, (CU_VAL|IM_VAL|KUIE_VAL)
    mtc0 k0, $12    # Write to status register.

    j kernel_init   # Initialize kernel software.
```

Figure 9: Example reset sequence.

4.2 Interrupts

The two interrupts possible on SMIPS are listed in Table 4 in order of decreasing priority.

Vector	ExcCode	Mnemonic	IM/IP index	Description
Highest Priority				
0x0000_1100	0	Hint	6	Tester interrupt.
0x0000_1100	2	Tint	7	Timer interrupt.
Lowest Priority				

Table 4: SMIPS Interrupts.

All SMIPS interrupts are level triggered. For each interrupt there is an IP flag in the **cause** register that is set if that interrupt is pending, and an IM flag in the **status** register that enables the interrupt when set. In addition there is a single global interrupt enable bit, **iec**, that disables all interrupts if cleared. A particular interrupt can only occur if both IP and IM for that interrupt are set and **iec** is set, and there are no higher priority interrupts.

The host external interrupt flag IP6 can be written by the host test system over a scan interface. Usually a protocol over the host scan interface informs the host that it can clear down the interrupt flag.

The timer interrupt flag IP7 is set when the value in the **count** register matches the value in the **compare** register. The flag can only be cleared as a side-effect of a MTC0 write to the **compare** register.

When an interrupt is taken, the PC is set to the interrupt vector, and the KU/IE stack in the **status** register is pushed two bits to the left, with KUc and IEc both cleared to 0. This starts the interrupt handler running in kernel mode with further interrupts disabled. The **exccode** field in the **cause** register is set to indicate the type of interrupt.

The **epc** register is loaded with a restart address. The **epc** address can be used to restart execution after servicing the interrupt.

4.3 Synchronous Exceptions

Synchronous exceptions are listed in Table 5 in order of decreasing priority.

ExcCode	Mnemonic	Description
Highest Priority		
6	AdEF	Address or misalignment error on fetch.
10	RI	Reserved instruction exception.
8	Sys	Syscall exception.
9	Bp	Breakpoint exception.
12	Ov	Arithmetic Overflow.
4	AdEL	Address or misalignment error on load.
5	AdES	Address or misalignment error on store.
Lowest Priority		

Table 5: SMIPS Synchronous Exceptions.

After a synchronous exception, the PC is set to 0x0000_1100. The stack of kernel/user and interrupt enable bits held in the `status` register is pushed left two bits, and both `kuc` and `iec` are set to 0.

The `epc` register is set to point to the instruction that caused the exception. The `exccode` field in the `cause` register is set to indicate the type of exception.

If the exception was a coprocessor unusable exception (CpU), the `ce` field in the `cause` register is set to the coprocessor number that caused the error. This field is undefined for other exceptions.

The overflow exception (Ov) can only occur for ADDI, ADD, and SUB instructions.

If the exception was an address error on a load or store (AdEL/AdES), the `badvaddr` register is set to the faulting address. The value in `badvaddr` is undefined for other exceptions.

All unimplemented and illegal instructions should cause a reserved instruction exception (RI).

5 Instruction Semantics and Encodings

SMIPS uses the standard MIPS instruction set.

5.1 Instruction Formats

There are three basic instruction formats, R-type, I-type, and J-type. These are a fixed 32 bits in length, and must be aligned on a four-byte boundary in memory. An address error exception (AdEF) is generated if the PC is misaligned on an instruction fetch.

R-Type

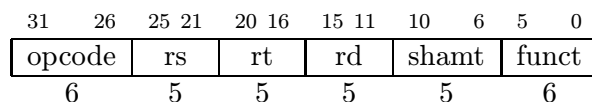

R-type instructions specify two source registers (*rs* and *rt*) and a destination register (*rd*). The 5-bit *shamt* field is used to specify shift immediate amounts and the 6-bit *funct* code is a second opcode field.

I-Type

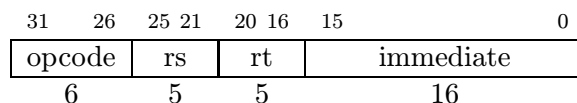

I-type instructions specify one source register (*rs*) and a destination register (*rt*). The second source operand is a sign or zero-extended 16-bit immediate. Logical immediate operations use a zero-extended immediate, while all others use a sign-extended immediate.

J-Type

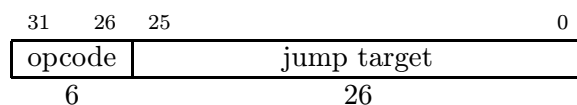

J-type instructions encode a 26-bit jump target address. This value is shifted left two bits to give a byte address then combined with the top four bits of the current program counter.

5.2 Instruction Categories

MIPS instructions can be grouped into several basic categories: loads and stores, computation instructions, branch and jump instructions, and coprocessor instructions.

Load and Store Instructions

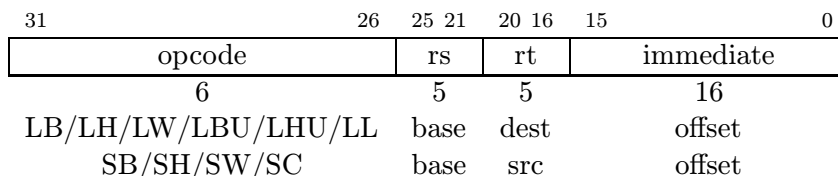

Load and store instructions transfer a value between the registers and memory and are encoded with the I-type format. The effective address is obtained by adding register *rs* to the sign-extended immediate. Loads place a value in register *rt*. Stores write the value in register *rt* to memory.

The LW and SW instructions load and store 32-bit register values respectively. The LH instruction loads a 16-bit value from memory and sign extends this to 32-bits before storing into register *rt*. The LHU instruction zero-extends the 16-bit memory value. Similarly LB and LBU load sign and zero-extended 8-bit values into register *rt* respectively. The SH instruction writes the low-order 16 bits of register *rt* to memory, while SB writes the low-order 8 bits.

The effective address must be naturally aligned for each data type (i.e., on a four-byte boundary for 32-bit loads/stores and a two-byte boundary for 16-bit loads/store). If not, an address exception (AdEL/AdES) is generated.

The load linked (LL) and store conditional (SC) instructions are used as primitives to implement atomic read-modify-write operations for multiprocessor synchronization. The LL instruction performs a standard load from the effective address (base+offset), but as a side effect the instruction should set a programmer invisible link address register. If for any reason atomicity is violated, then the link address register will be cleared. When the processor executes the SC instruction first, it first verifies that the link address register is still valid. If the link address register is valid then the SC executes as a standard SW instruction except that the src register is overwritten with a one to indicate success. If the link address register is invalid, then the SW instruction overwrites the src register with a zero to indicate failure. There are several reasons why atomicity might be violated. If the processor takes an exception after a LL instruction but before the corresponding SC instruction is executed then the link address register will be cleared. In a multi-processor system, if a different processor uses a SC instruction to write the same location then the link address register will also be cleared.

Computational Instructions

Computational instructions are either encoded as register-immediate operations using the I-type format or as register-register operations using the R-type format. The destination is register *rt* for register-immediate instructions and *rd* for register-register instructions.

There are only eight register-immediate computational instructions.

31	26	25	21	20	16	15	0
opcode		rs	rt	immediate			
6		5	5	16			
ADDI/ADDIU/SLTI/SLTIU		src	dest	sign-extended immediate			
ANDI/ORI/XORI/LUI		src	dest	zero-extended immediate			

ADDI and ADDIU add the sign-extended 16-bit immediate to register *rs*. The only difference between ADD and ADDIU is that ADDI generates an arithmetic overflow exception if the signed result would overflow 32 bits. SLTI (set less than immediate) places a 1 in the register *rt* if register *rs* is strictly less than the sign-extended immediate when both are treated as signed 32-bit numbers, else a 0 is written to *rt*. SLTIU is similar but compares the values as unsigned 32-bit numbers. [**NOTE: Both ADDIU and SLTIU sign-extend the immediate, even though they operate on unsigned numbers.**]

ANDI, ORI, XORI are logical operations that perform bit-wise AND, OR, and XOR on register *rs* and the zero-extended 16-bit immediate and place the result in *rt*.

LUI (load upper immediate) is used to build 32-bit immediates. It shifts the 16-bit immediate into the high-order 16-bits, shifting in 16 zeros in the low order bits, then places the result in register *rt*. The *rs* field must be zero.

[**NOTE: Shifts by immediate values are encoded in the R-type format using the *shamt* field.**]

Arithmetic R-type operations are encoded with a zero value (SPECIAL) in the major opcode. All operations read the *rs* and *rt* registers as source operands and write the result into register *rd*. The 6-bit *funct* field selects the operation type from ADD, ADDU, SUB, SUBU, SLT, SLTU, AND, OR, XOR, and NOR.

31	26	25	21	20	16	15	11	10	6	5	0
opcode		rs	rt	rd	shamt	funct					
6		5	5	5	5	6					
SPECIAL=0		src1	src2	dest	0	ADD/ADDU/SUB/SUBU					
SPECIAL=0		src1	src2	dest	0	SLT/SLTU					
SPECIAL=0		src1	src2	dest	0	AND/OR/XOR/NOR					

ADD and SUB perform add and subtract respectively, but signal an arithmetic overflow if the result would overflow the signed 32-bit destination. ADDU and SUBU are identical to ADD/SUB except no trap is created on overflow. SLT and SLTU performed signed and unsigned compares

respectively, writing 1 to *rd* if *rs* < *rt*, 0 otherwise. AND, OR, XOR, and NOR perform bitwise logical operations. [**NOTE: NOR *rd*, *rx*, *rx* performs a logical inversion (NOT) of register *rx*.**]

Shift instructions are also encoded using R-type instructions with the SPECIAL major opcode. The operand that is shifted is always register *rt*. Shifts by constant values (SLL/SRL/SRA) have the shift amount encoded in the *shamt* field. Shifts by variable values (SLLV/SRLV/SRAV) take the shift amount from the bottom five bits of register *rs*. SLL/SLLV are logical left shifts, with zeros shifted into the least significant bits. SRL/SRLV are logical right shifts with zeros shifted into the most significant bits. SRA/SRAV are arithmetic right shifts which shift in copies of the original sign bit into the most significant bits.

31	26	25	21	20	16	15	11	10	6	5	0
opcode		rs	rt	rd	shamt	funct					
6		5	5	5	5	6					
SPECIAL=0		0	src	dest	shift	SLL/SRL/SRA					
SPECIAL=0		shift	src	dest	0	SLLV/SRLV/SRAV					

Multiply and divide instructions target the *hi* and *lo* registers and are encoded as R-type instructions under the SPECIAL major opcode. These instructions are fully interlocked in hardware. Multiply instructions take two 32-bit operands in registers *rs* and *rt* and store their 64-bit product in registers *hi* and *lo*. MULT performs a signed multiplication while MULTU performs an unsigned multiplication. DIV and DIVU perform signed and unsigned divides of register *rs* by register *rt* placing the quotient in *lo* and the remainder in *hi*. Divides by zero do not cause a trap. A software check can be inserted if required.

31	26	25	21	20	16	15	11	10	6	5	0
opcode		rs	rt	rd	shamt	funct					
6		5	5	5	5	6					
SPECIAL=0		src1	src2	0	0	MULT/MULTU/DIV/DIVU					
SPECIAL=0		0	0	dest	0	MFHI/MFLO					
SPECIAL=0		src	0	0	0	MTHI/MTLO					

The values calculated by a multiply or divide instruction are retrieved from the *hi* and *lo* registers using the MFHI (move from *hi*) and MFLO (move from *lo*) instructions, which write register *rd*. MTHI (move to *hi*) and MTLO (move to *lo*) instructions are also provided to allow the multiply registers to be written with the value in register *rs* (these instructions are used to restore user state after a context swap).

Jump and Branch Instructions

Jumps and branches can change the control flow of a program. Unlike the MIPS32 ISA, the SMIPS ISA does *not* have a programmer visible branch delay slot.

Absolute jumps (J) and jump and link (JAL) instructions use the J-type format. The 26-bit jump target is concatenated to the high order four bits of the program counter of the delay slot, then shifted left two bits to form the jump target address (using Verilog notation, the target address is $\{pc_plus4[31:28], target[25:0], 2'b0\}$). JAL stores the address of the instruction following the jump (PC+4) into register r31.

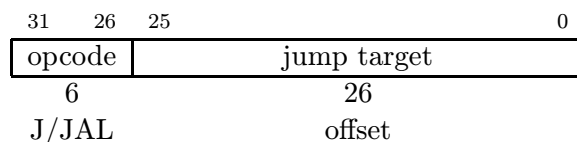

The indirect jump instructions, JR (jump register) and JALR (jump and link register), use the R-type encoding under a SPECIAL major opcode and jump to the address contained in register *rs*. JALR writes the link address into register *rd*.

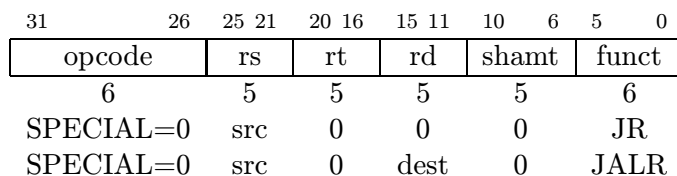

All branch instructions use the I-type encoding. The 16-bit immediate is sign-extended, shifted left two bits, then added to the address of the instruction in the delay slot (PC+4) to give the branch target address.

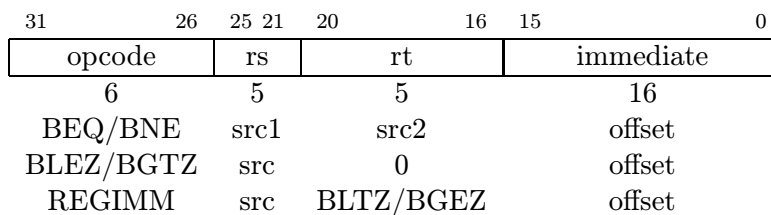

BEQ and BNE compare two registers and take the branch if they are equal or unequal respectively. BLEZ and BGTZ compare one register against zero, and branch if it is less than or equal to zero, or greater than zero, respectively. BLTZ and BGEZ examine the sign bit of the register *rs* and branch if it is negative or positive respectively.

System Coprocessor Instructions

The MTC0 and MFC0 instructions access the control registers in coprocessor 0, transferring a value from/to the coprocessor register specified in the *rd* field to/from the CPU register specified in the *rt* field. It is important to note that the coprocessor register is always in the *rd* field and the CPU register is always in the *rt* field regardless of which register is the source and which is the destination.

31	26	25	21	20	16	15	11	10	6	5	0
opcode		rs		rt		rd		shamt		funct	
6		5		5		5		5		6	
COP0		MF	dest		cop0src		0		0		
COP0		MT	src		cop0dest		0		0		
COP0		CO	0		0		0		0		ERET

The restore from exception instruction, ERET, returns to the interrupted instruction at the completion of interrupt or exception processing. An ERET instruction should pop the top value of the interrupt and kernel/user status register stack, restoring the previous values.

Coprocessor 2 Instructions

Coprocessor 2 is reserved for an implementation defined hardware unit. The MTC2 and MFC2 instructions access the registers in coprocessor 2, transferring a value from/to the coprocessor register specified in the *rd* field to/from the CPU register specified in the *rt* field. The CTC2 and CFC2 instructions serve a similar process. The Coprocessor 2 implementation is free to handle the coprocessor register specifiers in MTC2/MFC2 and CTC2/CFC2 in any way it wishes.

31	26	25	21	20	16	15	11	10	6	5	0
opcode		rs		rt		rd		shamt		funct	
6		5		5		5		5		6	
COP2		MF	dest		cop2src		0		0		
COP2		MT	src		cop2dest		0		0		
COP2		CF	dest		cop2src		0		0		
COP2		CT	src		cop2dest		0		0		

The LWC2 and SWC2 instructions transfer values between memory and the coprocessor registers. Note that although *cop2dest* and *cop2src* fields are coprocessor register specifiers, the ISA does not define how these correspond to the coprocessor register specifiers in other Coprocessor 2 instructions.

31	26	25	21	20	16	15	0
opcode		rs		rt		immediate	
6		5		5		16	
LWC2		base	cop2dest		offset		
SWC2		base	cop2src		offset		

The COP2 instruction is the primary mechanism by which a programmer can specify instruction bits to control Coprocessor 2. The 25-bit *copfunc* field is completely implementation dependent.

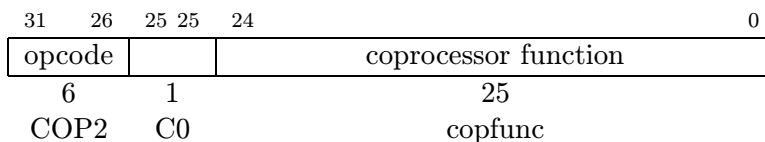

Special Instructions

The SYSCALL and BREAK instructions are useful for implementing operating systems and debuggers. The SYNC instruction can be necessary to guarantee strong load/store ordering in modern multi-processors with sophisticated memory systems.

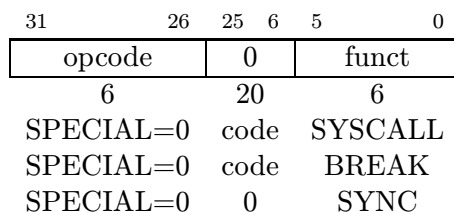

The SYSCALL and BREAK instructions cause an immediate syscall or break exception. To access the code field for use as a software parameter, the exception handler must load the memory location containing the syscall instruction.

The SYNC instruction is used to order loads and stores. All loads and stores before the SYNC instruction must be visible to all other processors in the system before any of the loads and stores following the SYNC instruction are visible.

5.3 SMIPS Variants

The SMIPS specification defines three SMIPS subsets: SMIPsv1, SMIPsv2, and SMIPsv3. SMIPsv1 includes the following five instructions: ADDIU, BNE, LW, SW, and MTC0. The `tohost` register is the only implemented system coprocessor register. SMIPsv2 includes all of the simple arithmetic instructions except for those which throw overflow exceptions. It does not include multiply or divide instructions. SMIPsv2 only supports word loads and stores. All jumps and branches are supported. Neither SMIPsv1 or SMIPsv2 support exceptions, interrupts, or most of the system coprocessor. SMIPsv3 is the full SMIPS ISA and includes everything described in this document except for Coprocessor 2 instructions. Table 7 notes which instructions are supported in each variant.

5.4 Unimplemented instructions

Several instructions in the MIPS32 instruction set are not supported by the SMIPS. These instructions should cause a reserved instruction exception (RI) and can be emulated in software by an

exception handler.

The misaligned load/store instructions, Load Word Left (LWL), Load Word Right (LWR), Store Word Left (SWL), and Store Word Right (SWR), are not implemented. A trap handler can emulate the misaligned access. Compilers for SMIPS should avoid generating these instructions, and should instead generate code to perform the misaligned access using multiple aligned accesses.

The MIPS32 trap instructions, TGE, TGEU, TLT, TLTU, TEQ, TNE, TGEI, TGEIU, TLTI, TLTIU, TEQI, TNEI, are not implemented. The illegal instruction trap handler can perform the comparison and if the condition is met jump to the appropriate exception routine, otherwise resume user mode execution after the trap instruction. Alternatively, these instructions may be synthesized by the assembler, or simply avoided by the compiler.

The floating point coprocessor (COP1) is not supported. All MIPS32 coprocessor 1 instructions are trapped to allow emulation of floating-point. For higher performance, compilers for SMIPS could directly generate calls to software floating point code libraries rather than emit coprocessor instructions that will cause traps, though this will require modifying the standard MIPS calling convention.

Branch likely and branch and link instructions are not implemented and cannot be emulated so they should be avoided by compilers for SMIPS.

	31	26	25	21	20	16	15	11	10	6	5	0	
	opcode		rs	rt	rd	shamt		funct					R-type
	opcode		rs	rt	immediate								I-type
	opcode		target										J-type
Load and Store Instructions													
v3	100000	base	dest	signed offset									LB rt, offset(rs)
v3	100001	base	dest	signed offset									LH rt, offset(rs)
v1	100011	base	dest	signed offset									LW rt, offset(rs)
v3	100100	base	dest	signed offset									LBU rt, offset(rs)
v3	100101	base	dest	signed offset									LHU rt, offset(rs)
v3	110000	base	dest	signed offset									LL rt, offset(rs)
v3	101000	base	src	signed offset									SB rt, offset(rs)
v3	101001	base	src	signed offset									SH rt, offset(rs)
v1	101011	base	src	signed offset									SW rt, offset(rs)
v3	111000	base	src	signed offset									SC rt, offset(rs)
I-Type Computational Instructions													
v3	001000	src	dest	signed immediate									ADDI rt, rs, signed-imm.
v1	001001	src	dest	signed immediate									ADDIU rt, rs, signed-imm.
v2	001010	src	dest	signed immediate									SLTI rt, rs, signed-imm.
v2	001011	src	dest	signed immediate									SLTIU rt, rs, signed-imm.
v2	001100	src	dest	zero-ext. immediate									ANDI rt, rs, zero-ext-imm.
v2	001101	src	dest	zero-ext. immediate									ORI rt, rs, zero-ext-imm.
v2	001110	src	dest	zero-ext. immediate									XORI rt, rs, zero-ext-imm.
v2	001111	00000	dest	zero-ext. immediate									LUI rt, zero-ext-imm.
R-Type Computational Instructions													
v2	000000	00000	src	dest	shamt	000000						SLL rd, rt, shamt	
v2	000000	00000	src	dest	shamt	000010						SRL rd, rt, shamt	
v2	000000	00000	src	dest	shamt	000011						SRA rd, rt, shamt	
v2	000000	rshamt	src	dest	00000	000100						SLLV rd, rt, rs	
v2	000000	rshamt	src	dest	00000	000110						SRLV rd, rt, rs	
v2	000000	rshamt	src	dest	00000	000111						SRAV rd, rt, rs	
v3	000000	src1	src2	dest	00000	100000						ADD rd, rs, rt	
v2	000000	src1	src2	dest	00000	100001						ADDU rd, rs, rt	
v3	000000	src1	src2	dest	00000	100010						SUB rd, rs, rt	
v2	000000	src1	src2	dest	00000	100011						SUBU rd, rs, rt	
v2	000000	src1	src2	dest	00000	100100						AND rd, rs, rt	
v2	000000	src1	src2	dest	00000	100101						OR rd, rs, rt	
v2	000000	src1	src2	dest	00000	100110						XOR rd, rs, rt	
v2	000000	src1	src2	dest	00000	100111						NOR rd, rs, rt	
v2	000000	src1	src2	dest	00000	101010						SLT rd, rs, rt	
v2	000000	src1	src2	dest	00000	101011						SLTU rd, rs, rt	

Table 6: Instruction listing for SMIPS.

	31	26	25	21	20	16	15	11	10	6	5	0	
	opcode		rs	rt	rd	shamt		funct					R-type
	opcode		rs	rt	immediate								I-type
	opcode		target										J-type
Multiply/Divide Instructions													
v3	000000		00000	00000	dest	00000		010000					MFHI rd
v3	000000		rs	00000	00000	00000		010001					MTHI rs
v3	000000		00000	00000	dest	00000		010010					MFLO rd
v3	000000		rs	00000	00000	00000		010011					MTLO rs
v3	000000		src1	src2	00000	00000		011000					MULT rs, rt
v3	000000		src1	src2	00000	00000		011001					MULTU rs, rt
v3	000000		src1	src2	00000	00000		011010					DIV rs, rt
v3	000000		src1	src2	00000	00000		011011					DIVU rs, rt
Jump and Branch Instructions													
v2	000010		target										J target
v2	000011		target										JAL target
v2	000000		src	00000	00000	00000		001000					JR rs
v2	000000		src	00000	dest	00000		001001					JALR rd, rs
v2	000100		src1	src2	signed offset							BEQ rs, rt, offset	
v2	000101		src1	src2	signed offset							BNE rs, rt, offset	
v2	000110		src	00000	signed offset							BLEZ rs, offset	
v2	000111		src	00000	signed offset							BGTZ rs, offset	
v2	000001		src	00000	signed offset							BLTZ rs, offset	
v2	000001		src	00001	signed offset							BGEZ rs, offset	
System Coprocessor (COP0) Instructions													
v2	010000		00000	dest	cop0src	00000		000000					MFC0 rt, rd
v2	010000		00100	src	cop0dest	00000		000000					MTC0 rt, rd
v3	010000		10000	00000	00000	00000		011000					ERET
Coprocessor 2 (COP2) Instructions													
-	010010		00000	dest	cop2src	00000		000000					MFC2 rt, rd
-	010010		00100	src	cop2dest	00000		000000					MTC2 rt, rd
-	010010		00010	dest	cop2src	00000		000000					CFC2 rt, rd
-	010010		00110	src	cop2dest	00000		000000					CTC2 rt, rd
-	110010		base	cop2dest	signed offset							LWC2 rt, offset(rs)	
-	111010		base	cop2src	signed offset							SWC2 rt, offset(rs)	
-	010010		1	copfunc									COP2 copfunc
Special Instructions													
v3	000000		00000	00000	00000	00000		001100					SYSCALL
v3	000000		00000	00000	00000	00000		001101					BREAK
v3	000000		00000	00000	00000	00000		001111					SYNC

Table 7: Instruction listing for SMIPS.

References

- [1] J. L. Hennessy and D. A. Patterson. *Computer Organization and Design: The Hardware/Software Interface*. Morgan Kaufmann, second edition, February 1997. ISBN 1558604286.
- [2] MIPS Technologies Inc. MIPS32 architecture for programmers, 2002. http://www.mips.com/publications/processor_architecture.html
- [3] G. Kane and J. Heinrich. *MIPS RISC Architecture*. Prentice Hall, 2nd edition, September 1991. ISBN 0135904722.
- [4] D. Sweetman. *See MIPS Run*. Morgan Kaufmann, April 1999. ISBN 1558604103.