

# Directory-Based Cache Coherence

*Daniel Sanchez*

Computer Science and Artificial Intelligence Lab  
M.I.T.

# Maintaining Cache Coherence

---

It is sufficient to have hardware such that

- only one processor at a time has write permission for a location
- no processor can load a stale copy of the location after a write

# Maintaining Cache Coherence

---

It is sufficient to have hardware such that

- only one processor at a time has write permission for a location
- no processor can load a stale copy of the location after a write

⇒ A correct approach could be:

# Maintaining Cache Coherence

---

It is sufficient to have hardware such that

- only one processor at a time has write permission for a location
- no processor can load a stale copy of the location after a write

⇒ A correct approach could be:

write request:

The address is *invalidated* in all other caches *before* the write is performed

# Maintaining Cache Coherence

---

It is sufficient to have hardware such that

- only one processor at a time has write permission for a location
- no processor can load a stale copy of the location after a write

⇒ A correct approach could be:

write request:

The address is *invalidated* in all other caches *before* the write is performed

read request:

If a dirty copy is found in some cache, a write-back is performed before the memory is read

# Directory-Based Coherence

*(Censier and Feautrier, 1978)*

---

## Snoopy Protocols

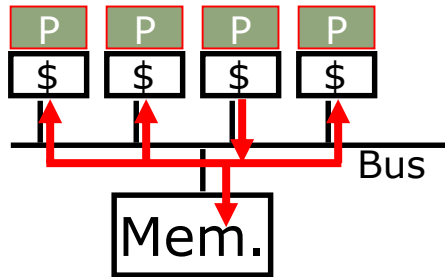

- Snoopy schemes broadcast requests over memory bus
- Difficult to scale to large numbers of processors
- Requires additional bandwidth to cache tags for snoop requests

# Directory-Based Coherence

*(Censier and Feautrier, 1978)*

---

## Snoopy Protocols

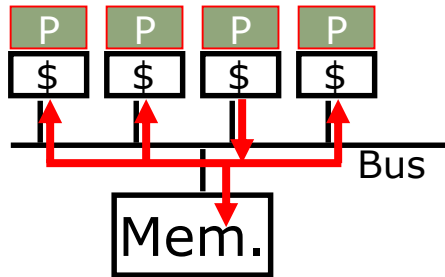

## Directory Protocols

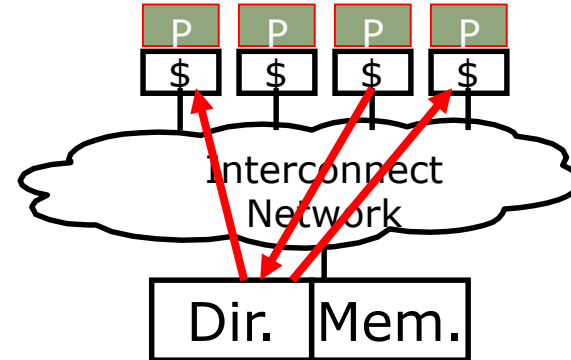

- Snoopy schemes broadcast requests over memory bus
- Difficult to scale to large numbers of processors
- Requires additional bandwidth to cache tags for snoop requests

# Directory-Based Coherence

(Censier and Feautrier, 1978)

---

## Snoopy Protocols

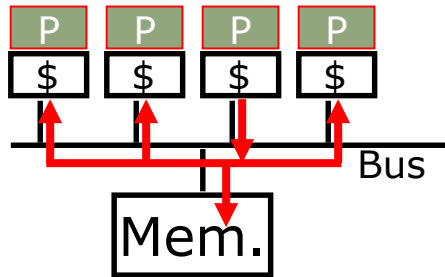

- Snoopy schemes broadcast requests over memory bus
- Difficult to scale to large numbers of processors
- Requires additional bandwidth to cache tags for snoop requests

## Directory Protocols

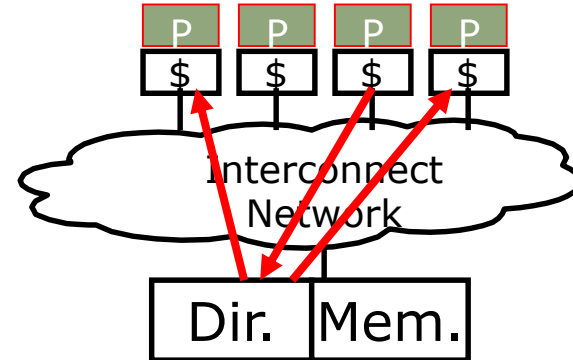

- Directory schemes send messages to only those caches that might have the line
- Can scale to large numbers of processors
- Requires extra directory storage to track possible sharers



# An MSI Directory Protocol

---

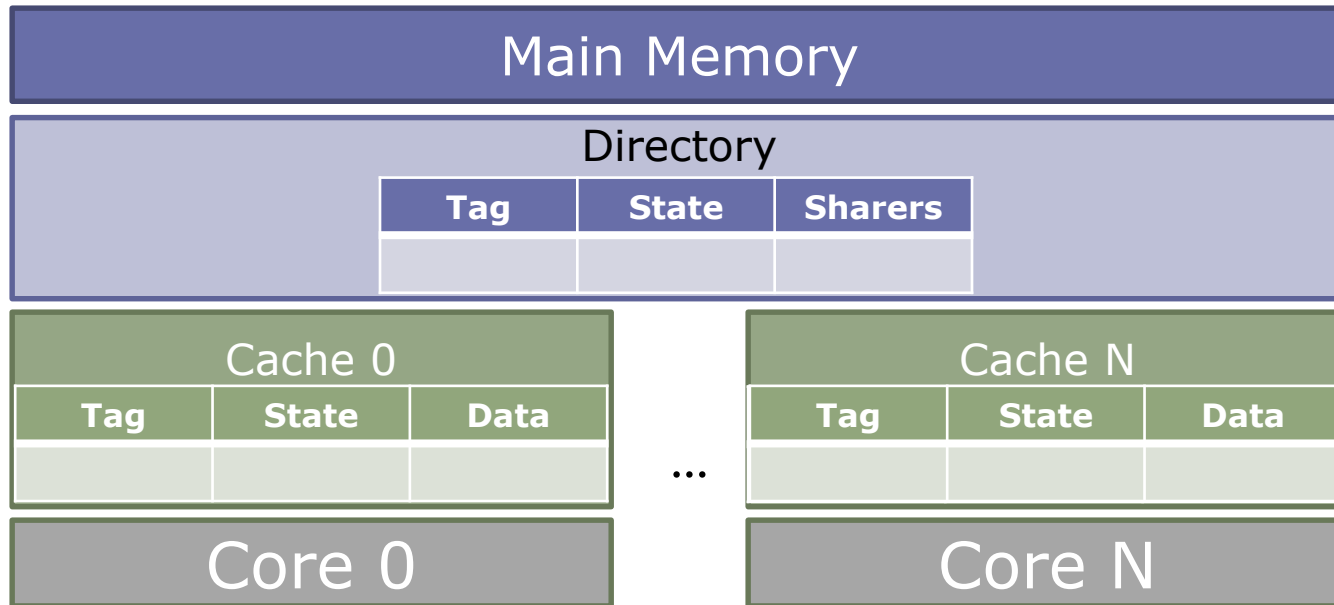

- Cache states: Modified (M) / Shared (S) / Invalid (I)

# An MSI Directory Protocol

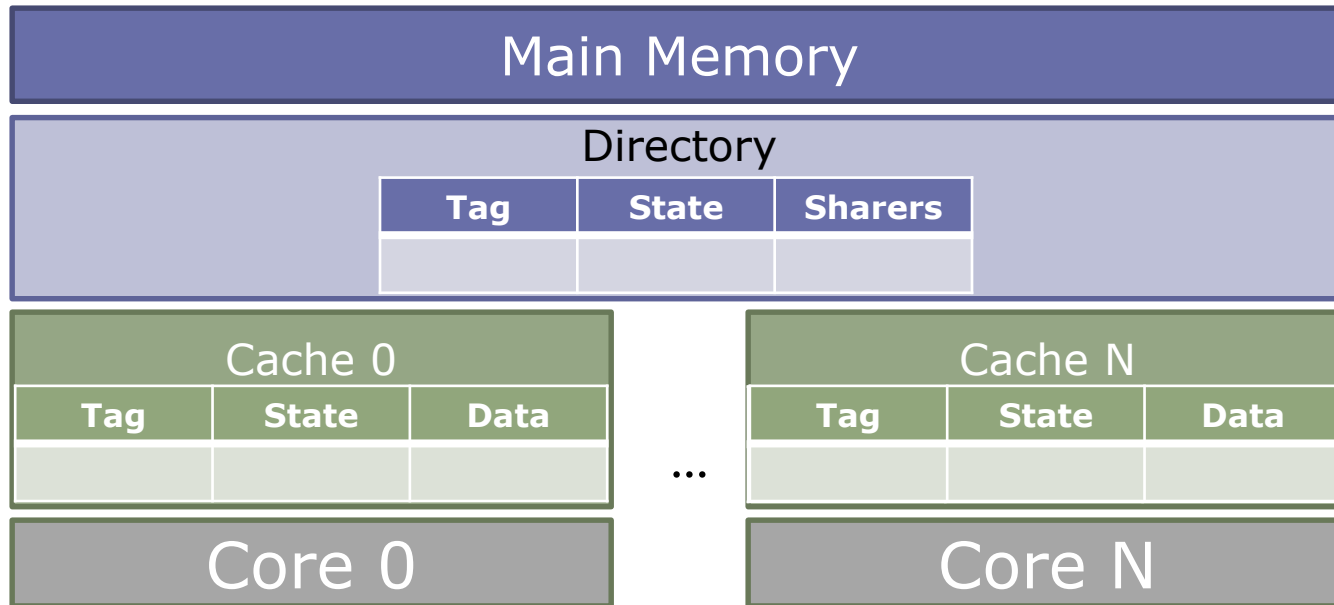

- Cache states: Modified (M) / Shared (S) / Invalid (I)
- Directory states:
  - Uncached (Un): No sharers
  - Shared (Sh): One or more sharers with read permission (S)
  - Exclusive (Ex): A single sharer with read & write permissions (M)

# An MSI Directory Protocol

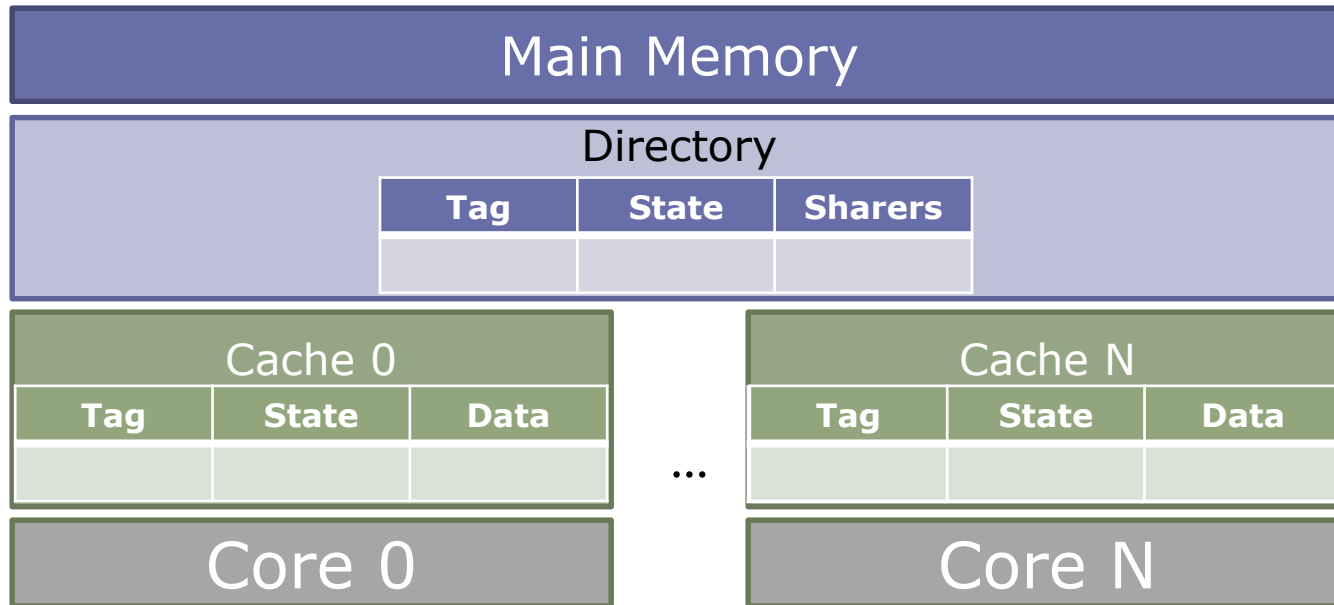

- Cache states: Modified (M) / Shared (S) / Invalid (I)
- Directory states:
  - Uncached (Un): No sharers
  - Shared (Sh): One or more sharers with read permission (S)
  - Exclusive (Ex): A single sharer with read & write permissions (M)
- Transient states not drawn for clarity; for now, assume no racing requests

# MSI Protocol: Caches (1/3)

---

Transitions initiated by processor accesses:

M

S

I

<b>Actions</b>
Processor Read (PrRd)
Processor Write (PrWr)
Shared Request (ShReq)
Exclusive Request (ExReq)

# MSI Protocol: Caches (1/3)

---

Transitions initiated by processor accesses:

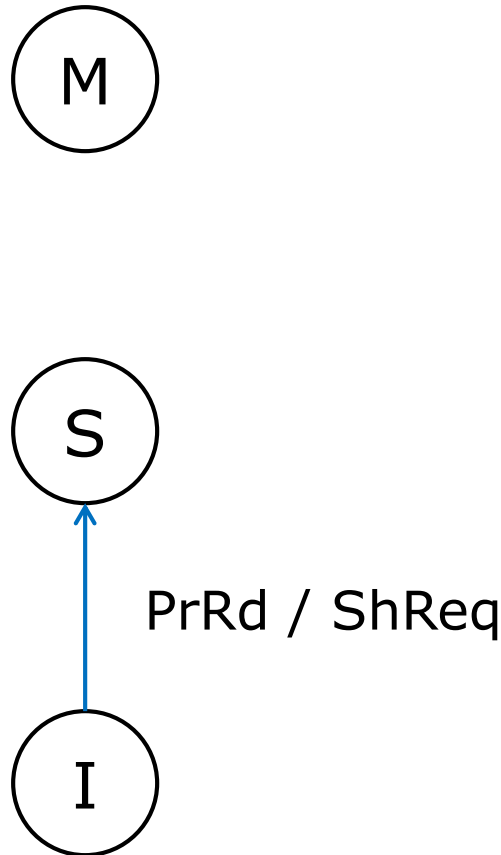

Actions
Processor Read (PrRd)
Processor Write (PrWr)
Shared Request (ShReq)
Exclusive Request (ExReq)

# MSI Protocol: Caches (1/3)

---

Transitions initiated by processor accesses:

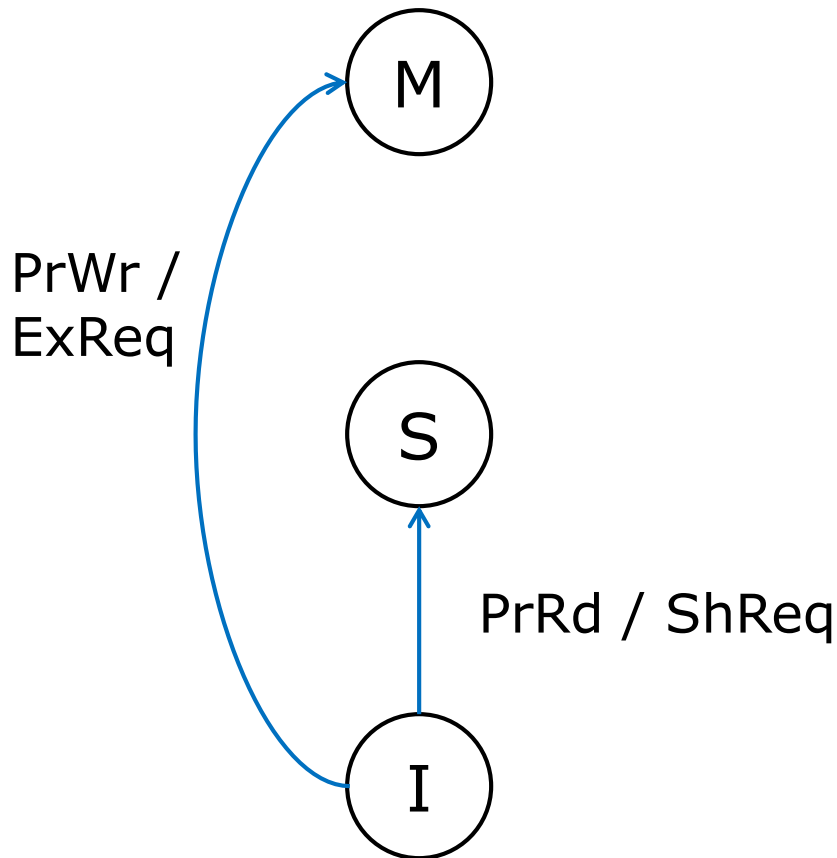

Actions
Processor Read (PrRd)
Processor Write (PrWr)
Shared Request (ShReq)
Exclusive Request (ExReq)

# MSI Protocol: Caches (1/3)

---

Transitions initiated by processor accesses:

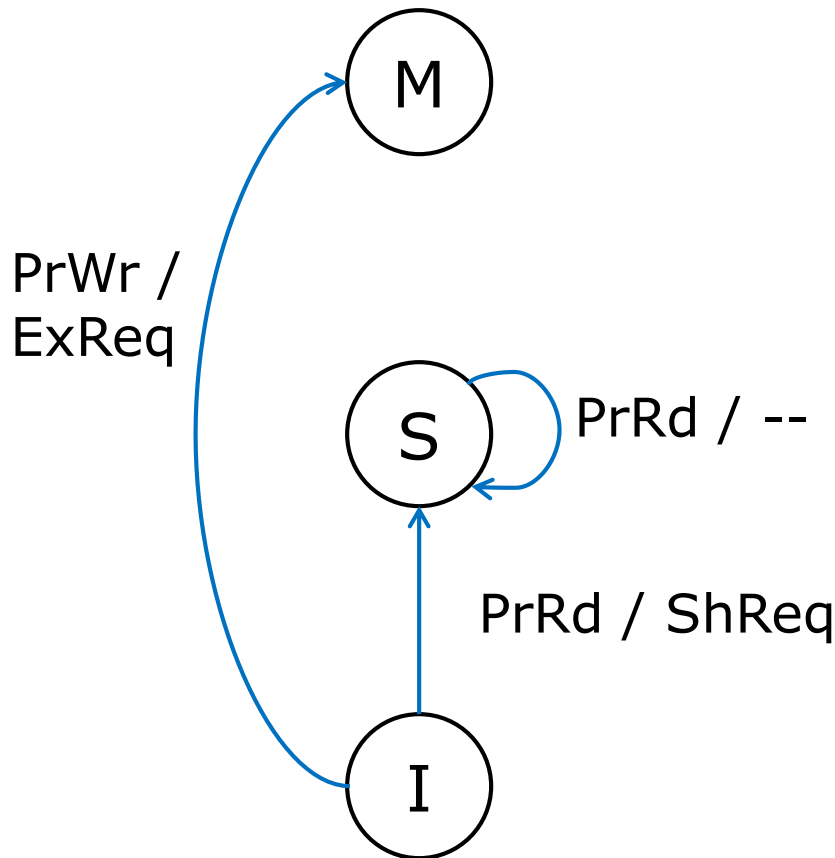

Actions
Processor Read (PrRd)
Processor Write (PrWr)
Shared Request (ShReq)
Exclusive Request (ExReq)

# MSI Protocol: Caches (1/3)

Transitions initiated by processor accesses:

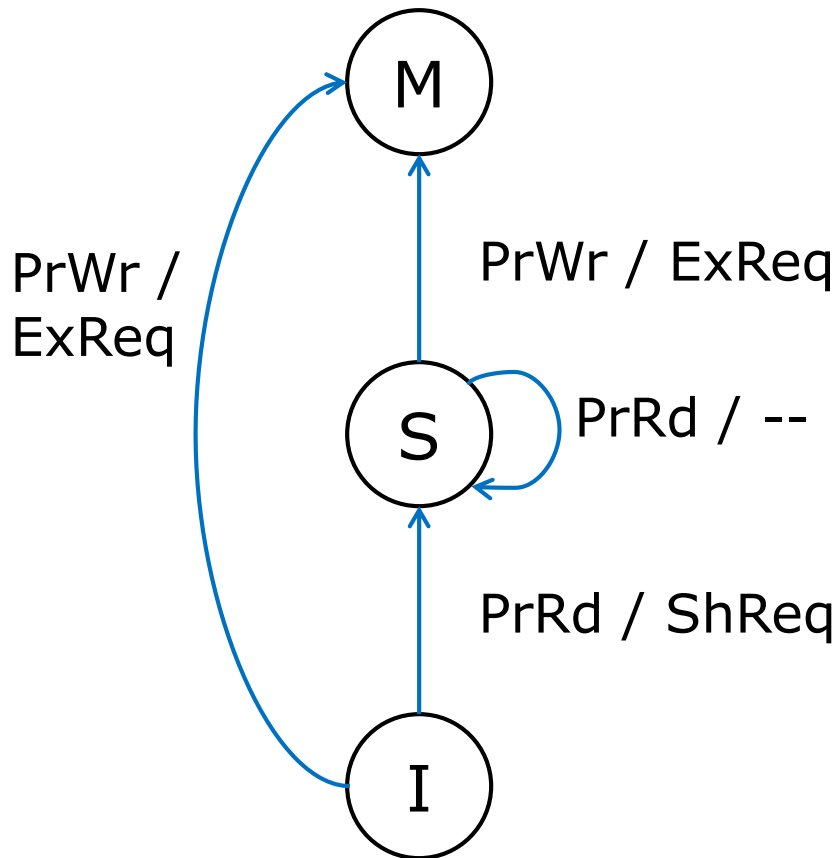

Actions
Processor Read (PrRd)
Processor Write (PrWr)
Shared Request (ShReq)
Exclusive Request (ExReq)



# MSI Protocol: Caches (1/3)

Transitions initiated by processor accesses:

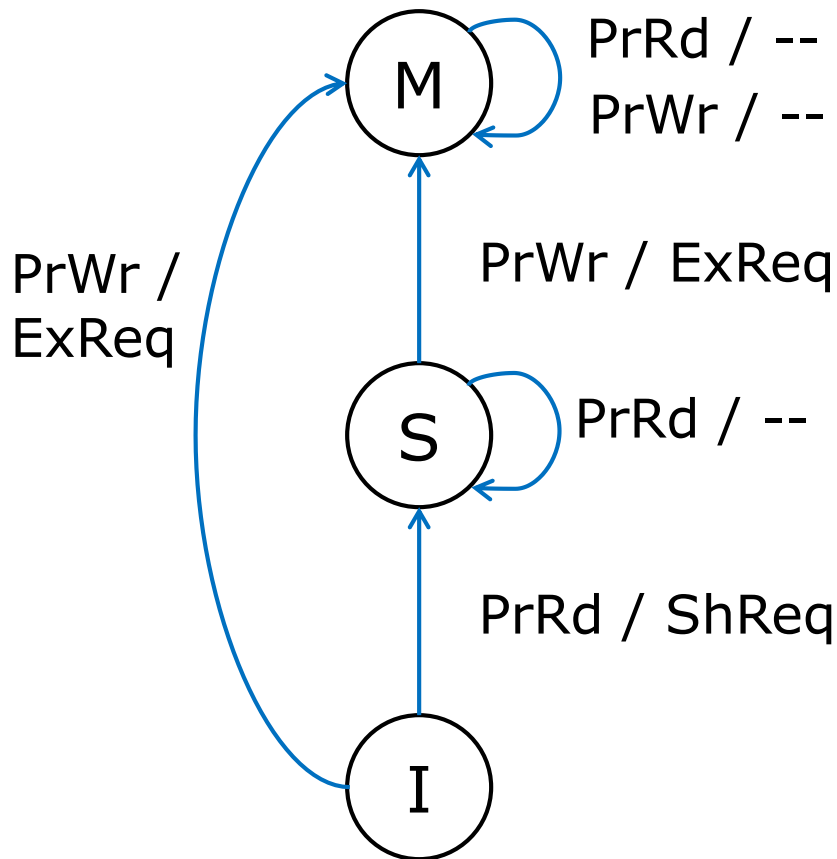

Actions
Processor Read (PrRd)
Processor Write (PrWr)
Shared Request (ShReq)
Exclusive Request (ExReq)

# MSI Protocol: Caches (2/3)

---

Transitions initiated by directory requests:

M

S

I

Actions
Invalidation Request (InvReq)
Downgrade Request (DownReq)
Invalidation Response (InvResp)
Downgrade Response (DownResp)

# MSI Protocol: Caches (2/3)

---

Transitions initiated by directory requests:

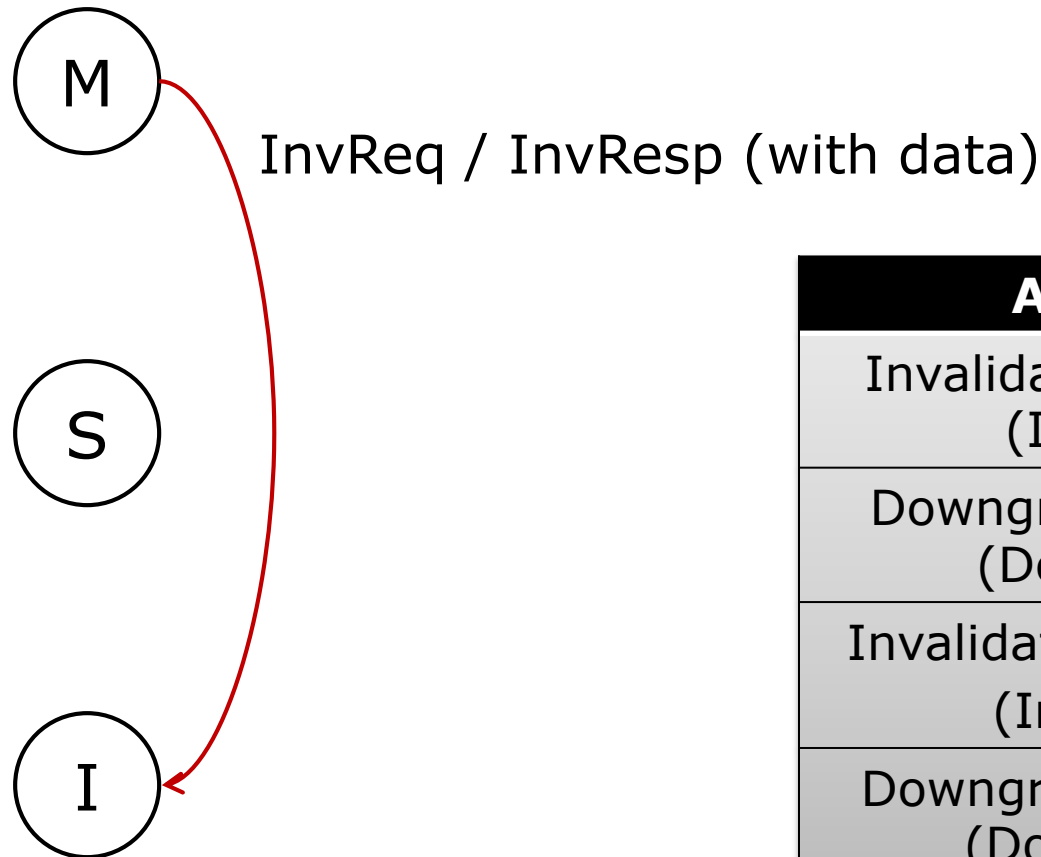

Actions
Invalidation Request (InvReq)
Downgrade Request (DownReq)
Invalidation Response (InvResp)
Downgrade Response (DownResp)

# MSI Protocol: Caches (2/3)

Transitions initiated by directory requests:

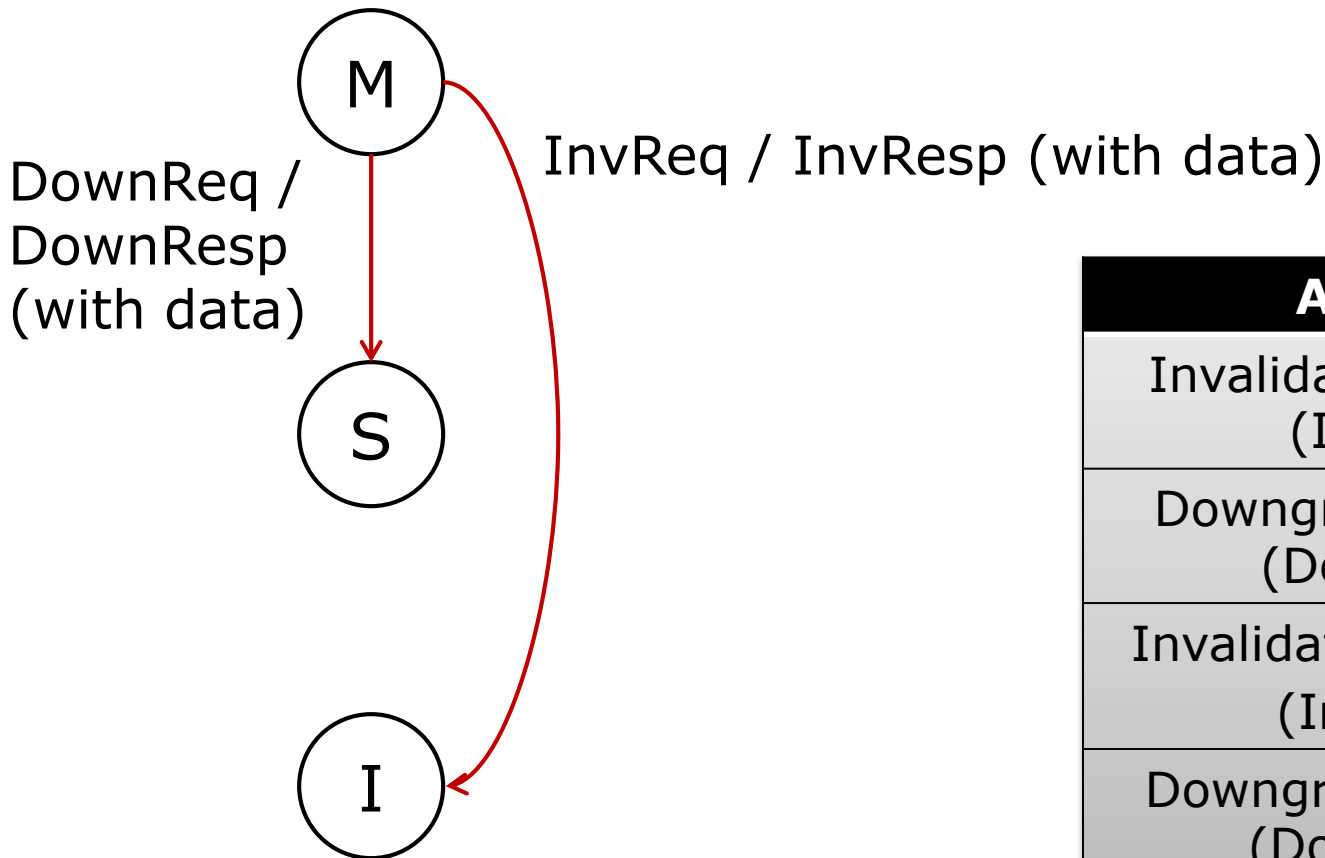

Actions
Invalidation Request (InvReq)
Downgrade Request (DownReq)
Invalidation Response (InvResp)
Downgrade Response (DownResp)

# MSI Protocol: Caches (2/3)

Transitions initiated by directory requests:

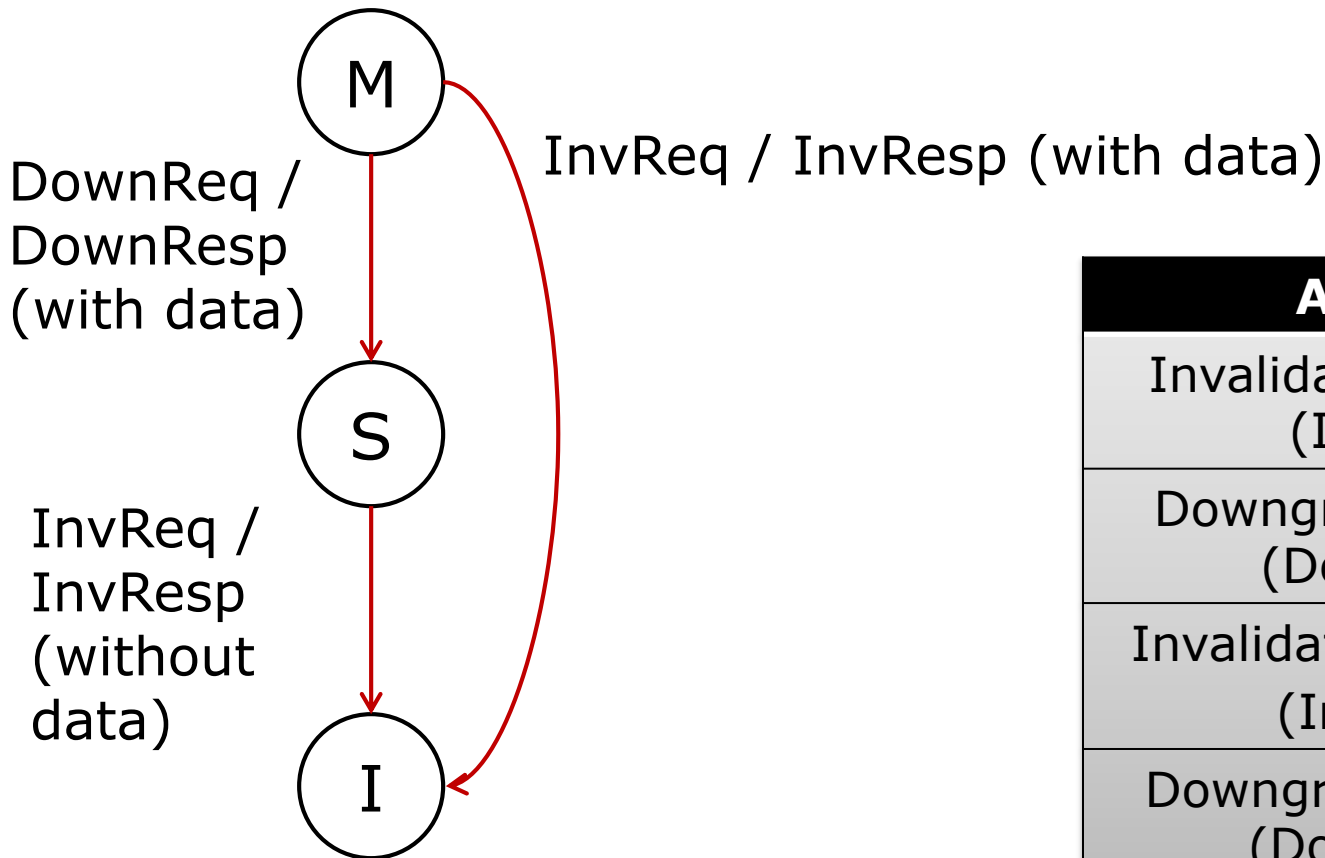

Actions
Invalidation Request (InvReq)
Downgrade Request (DownReq)
Invalidation Response (InvResp)
Downgrade Response (DownResp)

# MSI Protocol: Caches (3/3)

---

Transitions initiated by evictions:

M

S

I

Actions
Writeback Request (WbReq)

# MSI Protocol: Caches (3/3)

---

Transitions initiated by evictions:

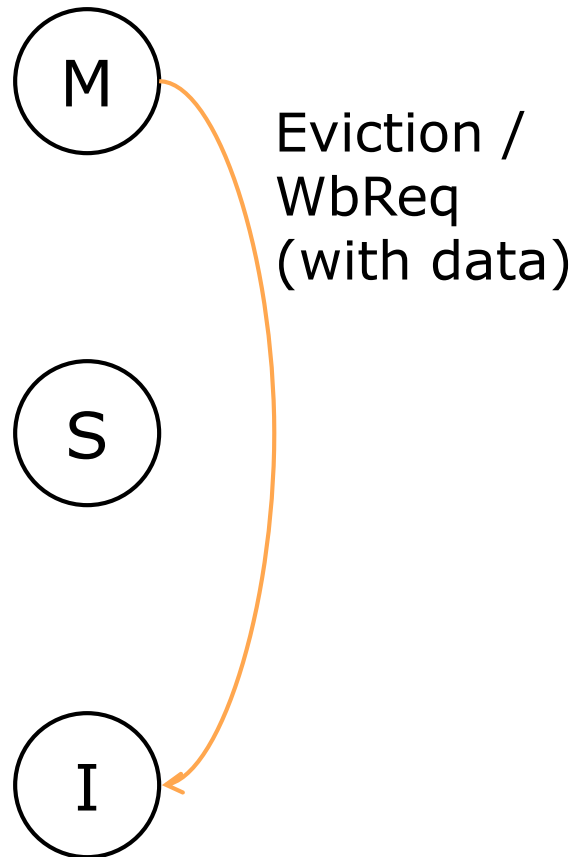

<b>Actions</b>
Writeback Request (WbReq)

# MSI Protocol: Caches (3/3)

---

Transitions initiated by evictions:

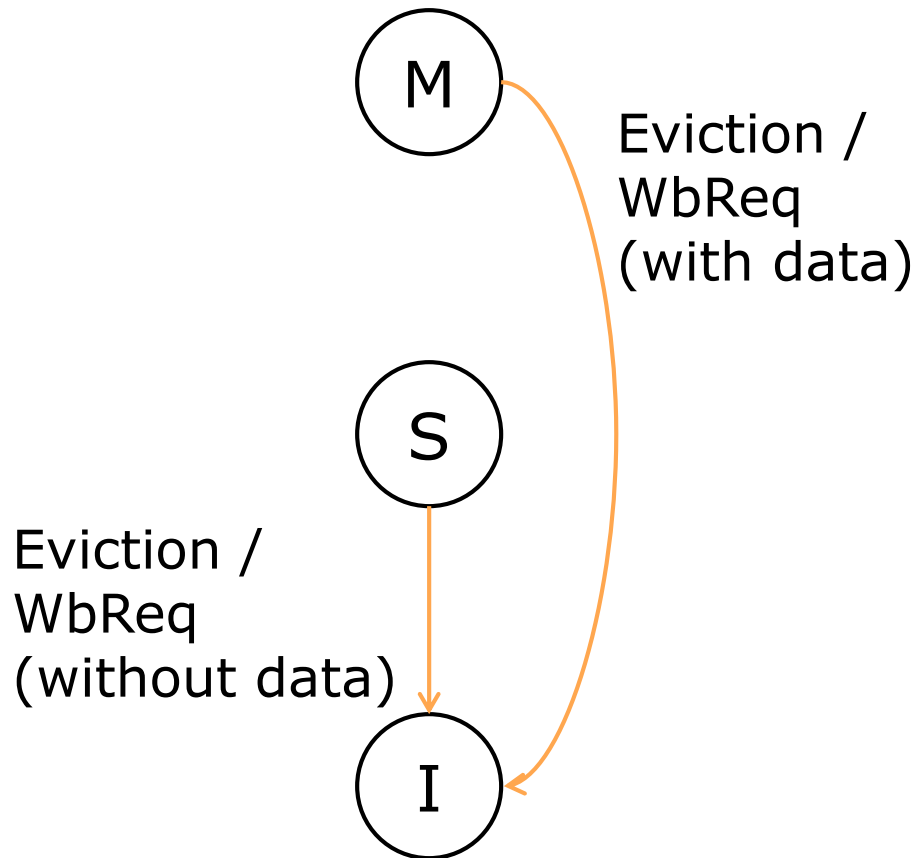

Actions
Writeback Request (WbReq)



# MSI Protocol: Caches

---

- Transitions initiated by processor accesses
- Transitions initiated by directory requests
- Transitions initiated by evictions

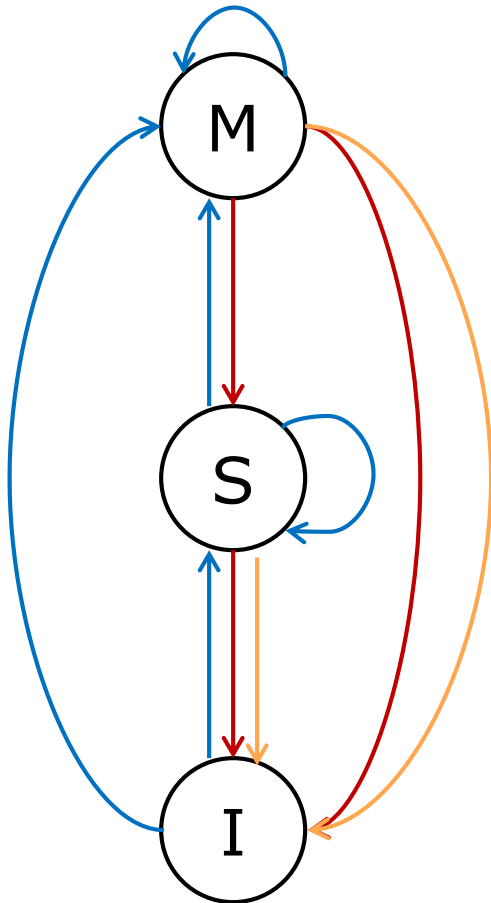

# MSI Protocol: Directory (1/2)

---

Transitions initiated by data requests:

Ex

Sh

Un

# MSI Protocol: Directory (1/2)

---

Transitions initiated by data requests:

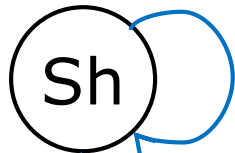

ShReq / Sharers = Sharers + {P}; ShResp

ShReq / Sharers = {P}; ShResp

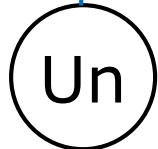

# MSI Protocol: Directory (1/2)

---

Transitions initiated by data requests:

ExReq / Sharers = {P}; ExResp

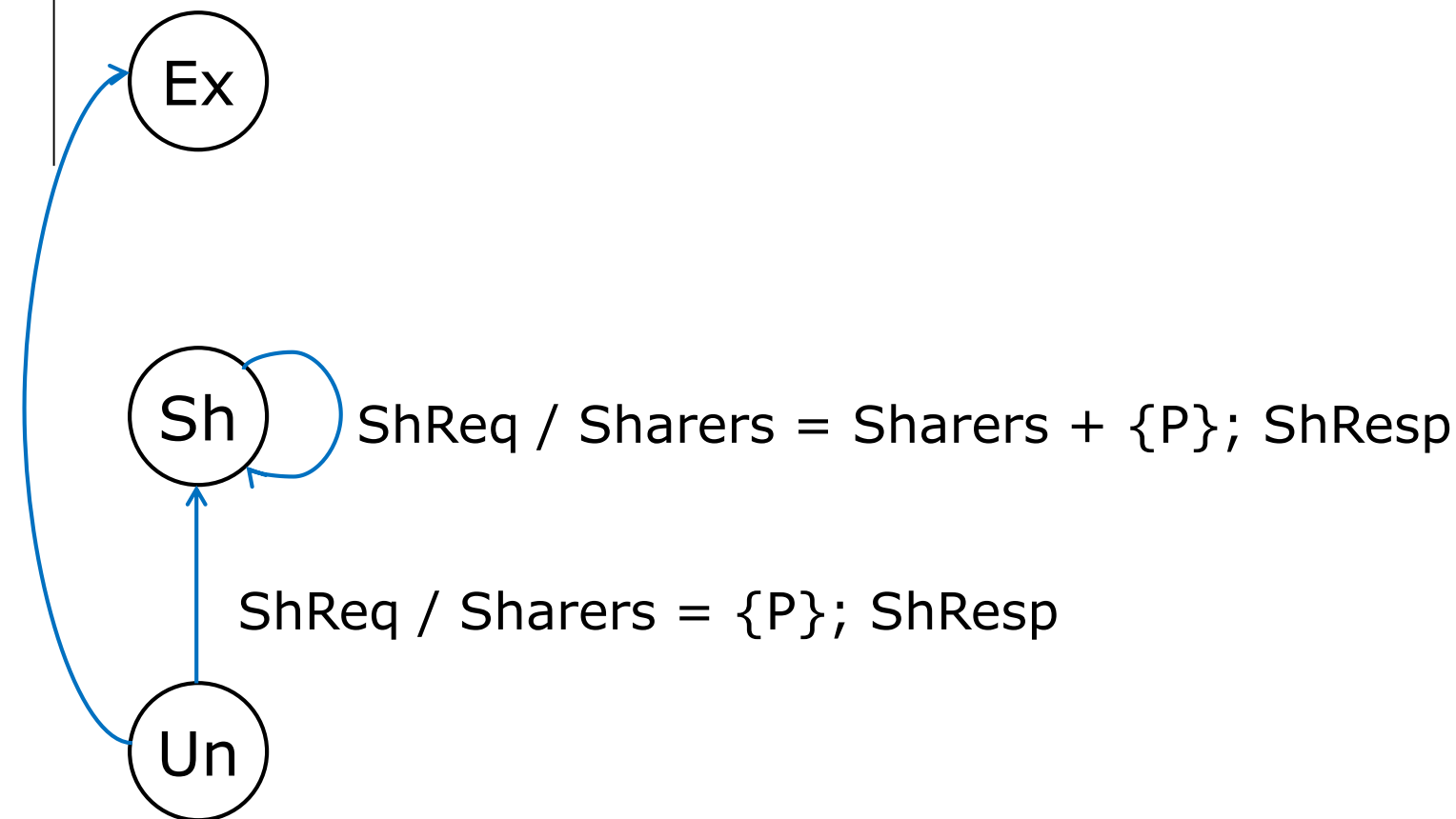

# MSI Protocol: Directory (1/2)

Transitions initiated by data requests:

ExReq / Sharers = {P}; ExResp

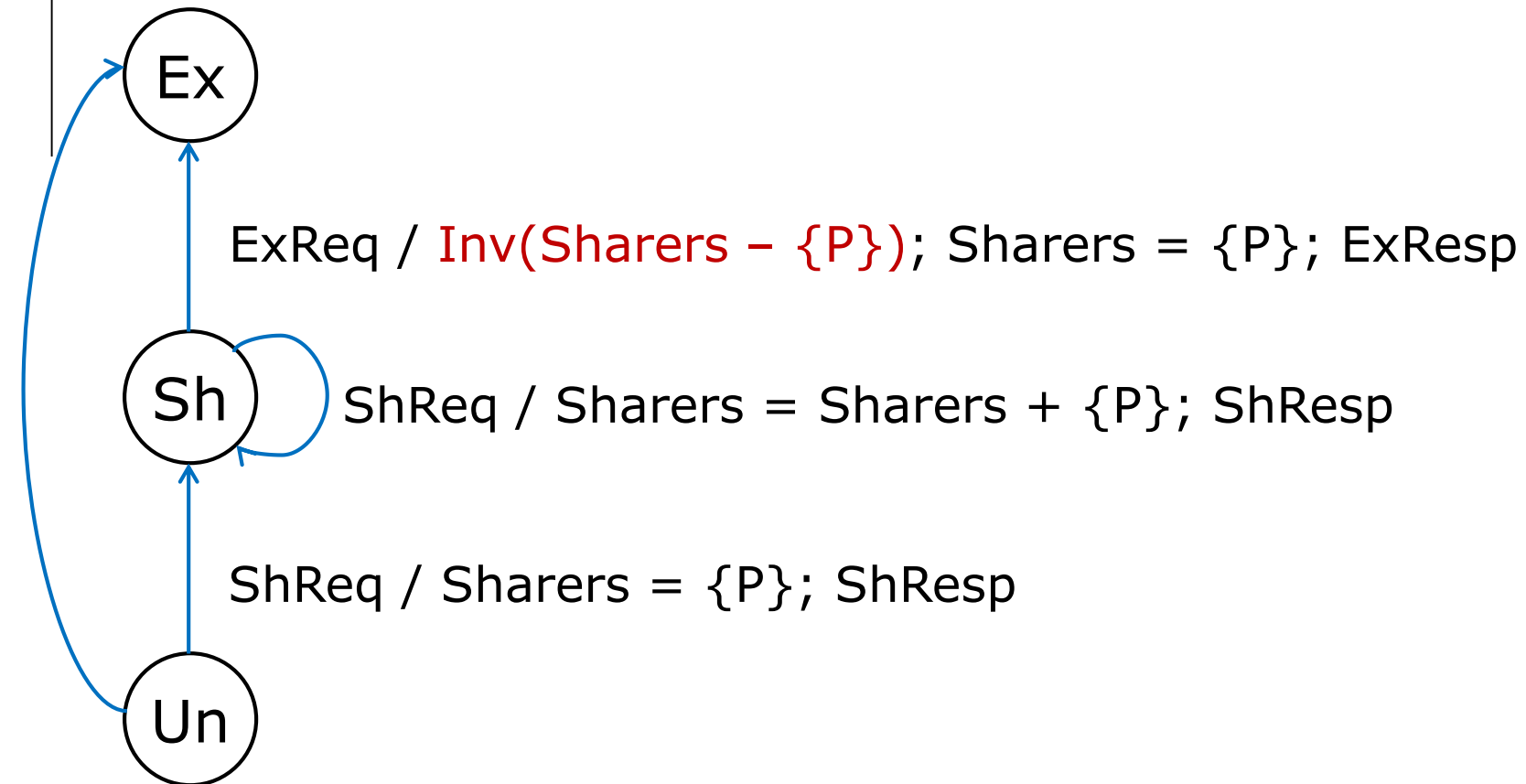

# MSI Protocol: Directory (1/2)

Transitions initiated by data requests:

ExReq / Sharers = {P}; ExResp

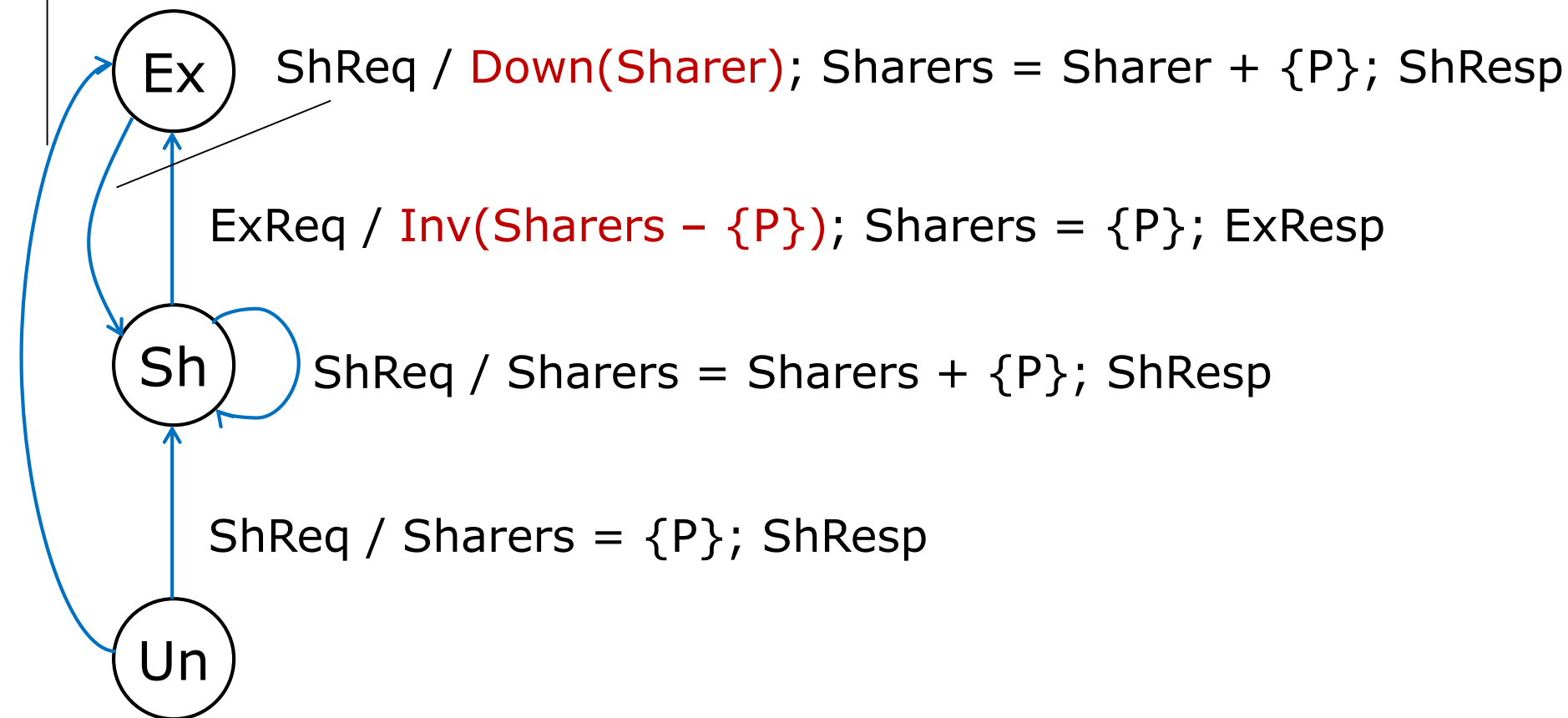

# MSI Protocol: Directory (2/2)

---

Transitions initiated by writeback requests:

Ex

Sh

Un

# MSI Protocol: Directory (2/2)

---

Transitions initiated by writeback requests:

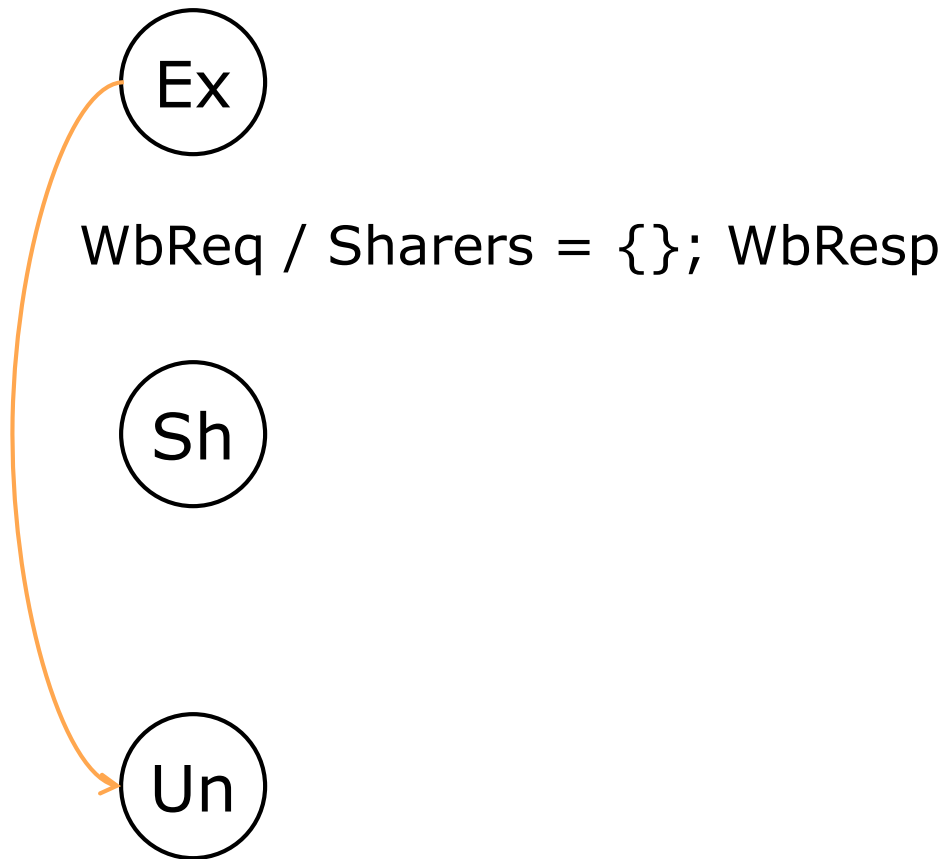



# MSI Protocol: Directory (2/2)

---

Transitions initiated by writeback requests:

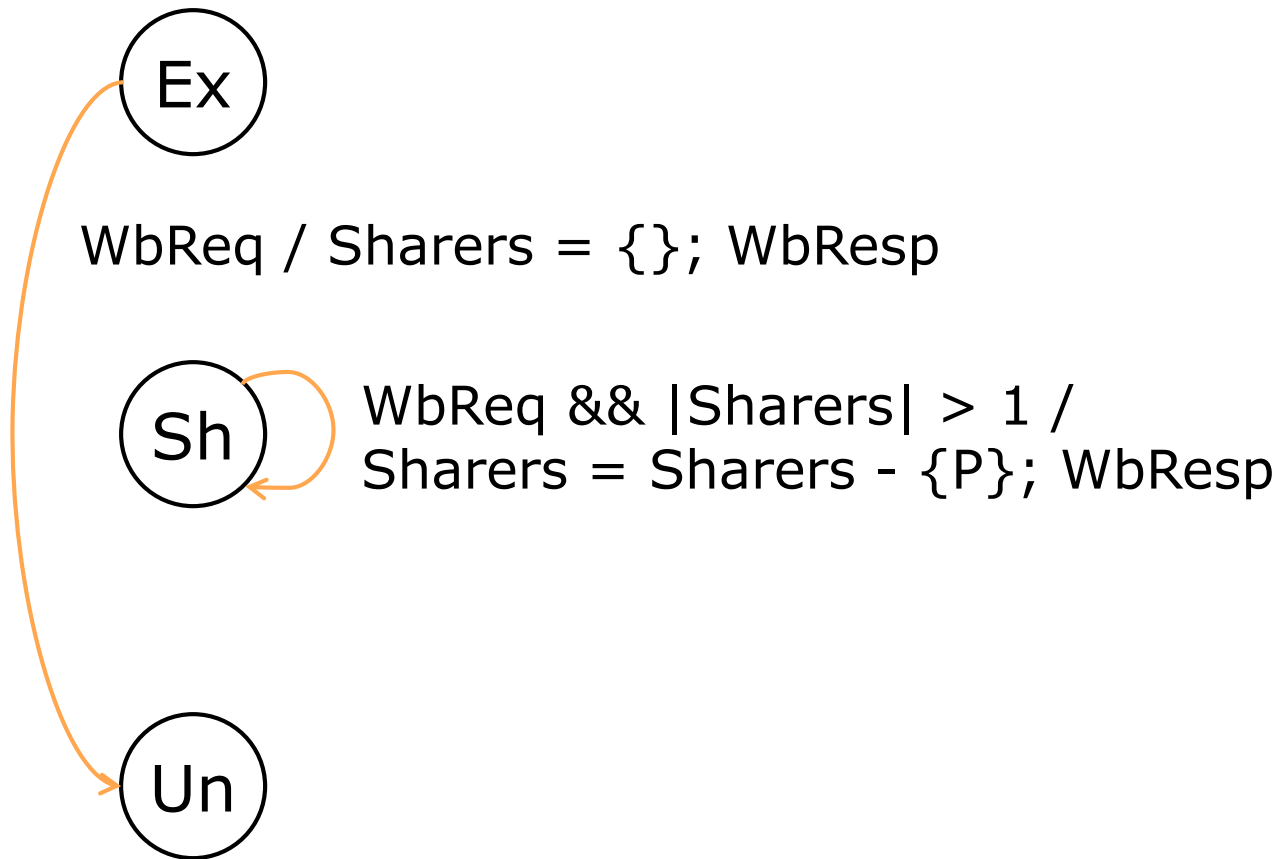

# MSI Protocol: Directory (2/2)

---

Transitions initiated by writeback requests:

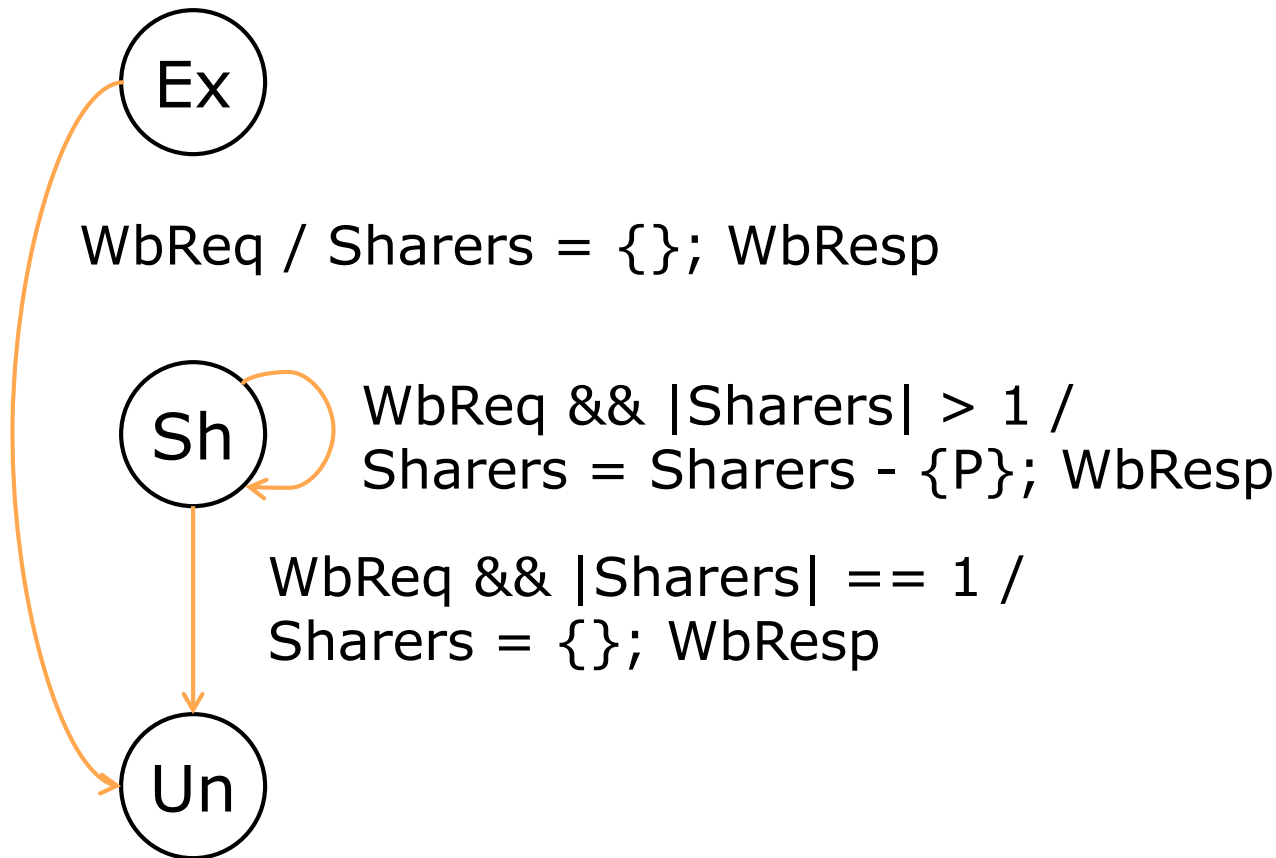

# MSI Directory Protocol Example

---

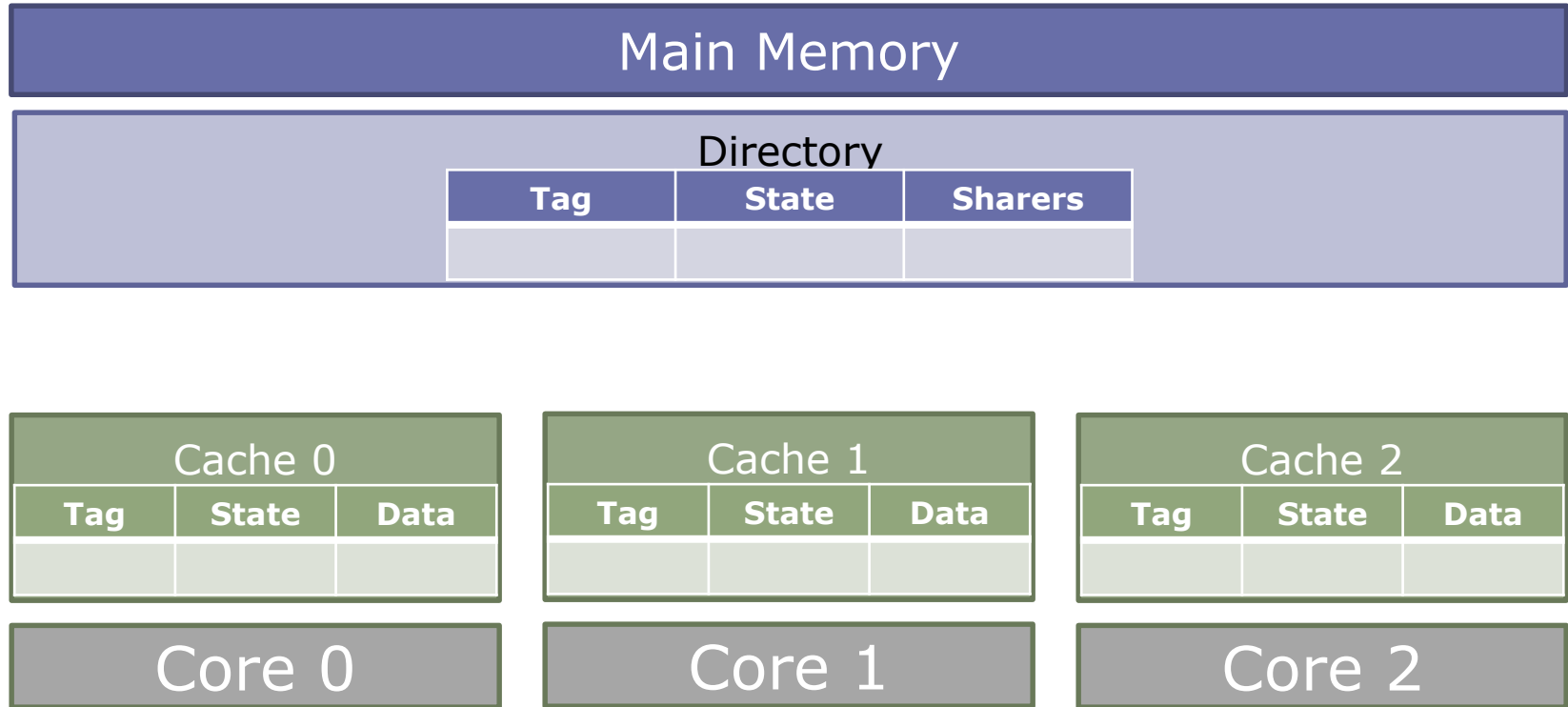

# MSI Directory Protocol Example

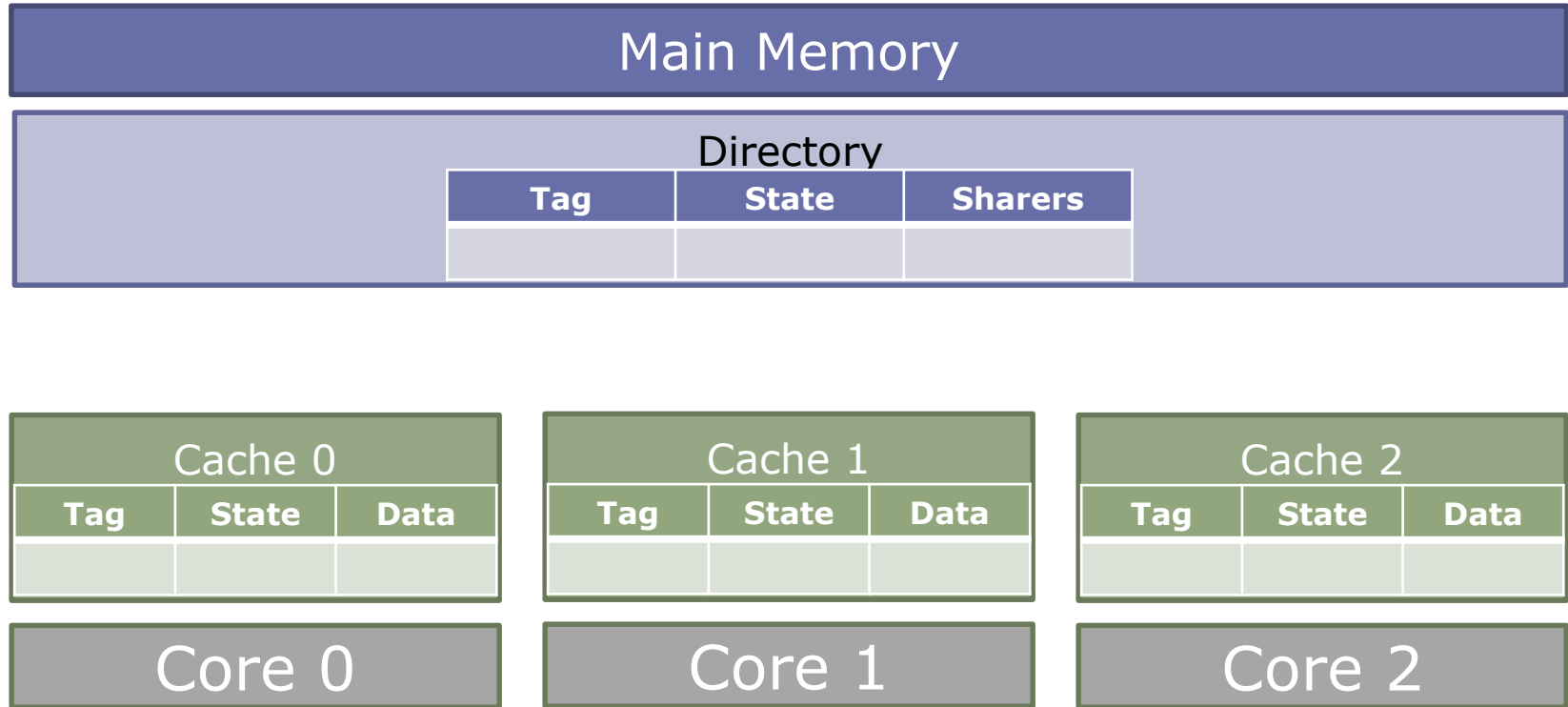

**1** LD 0xA

# MSI Directory Protocol Example

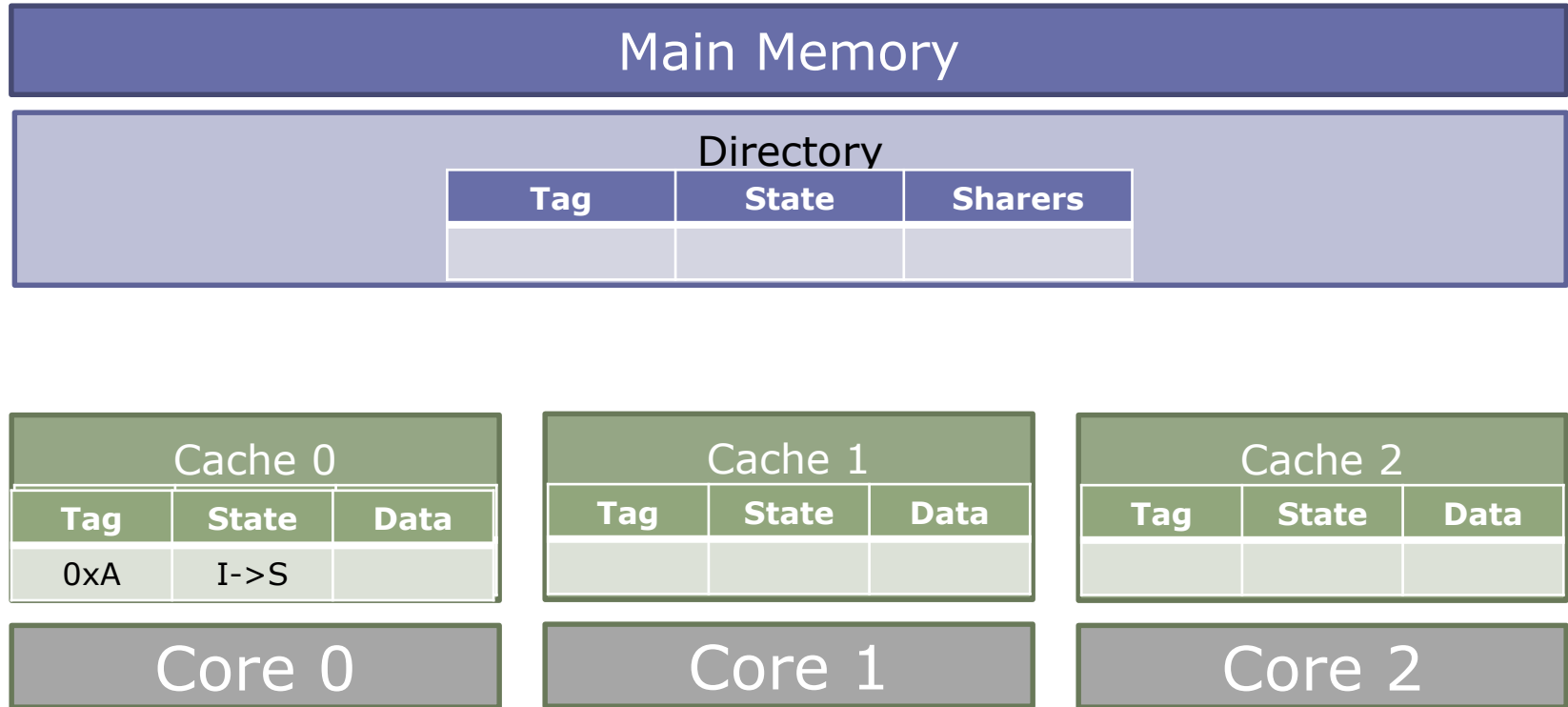

**1** LD 0xA

# MSI Directory Protocol Example

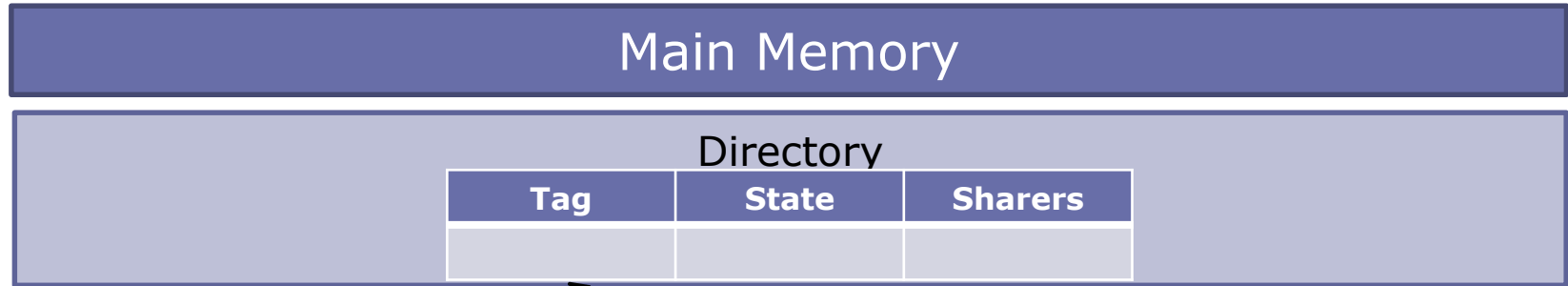

**2** ShReq 0xA

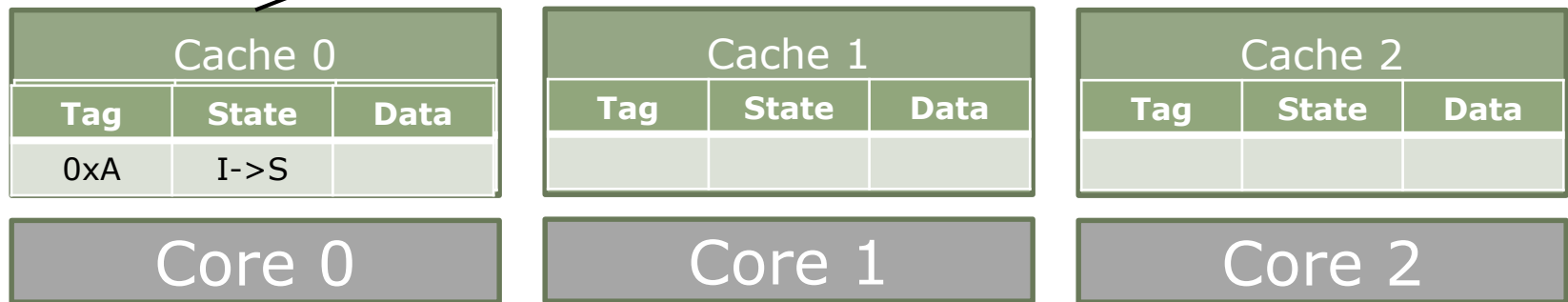

**1** LD 0xA

# MSI Directory Protocol Example

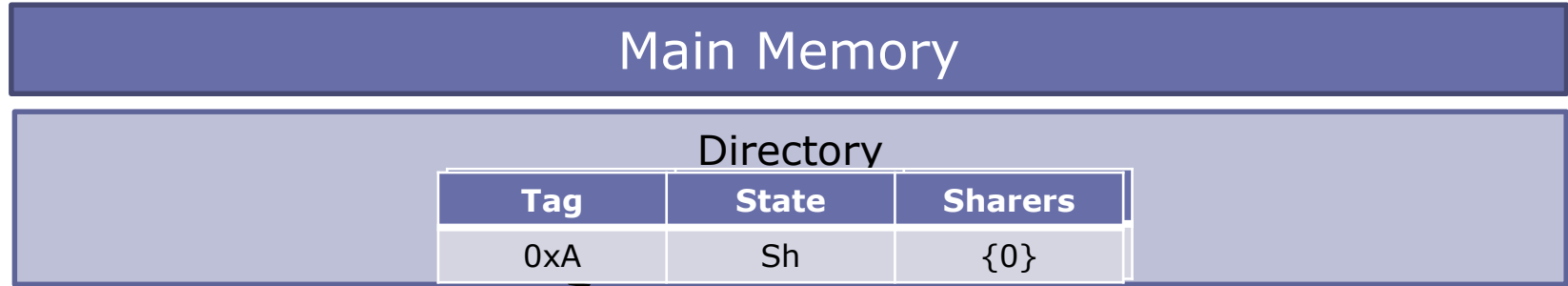

**2** ShReq 0xA

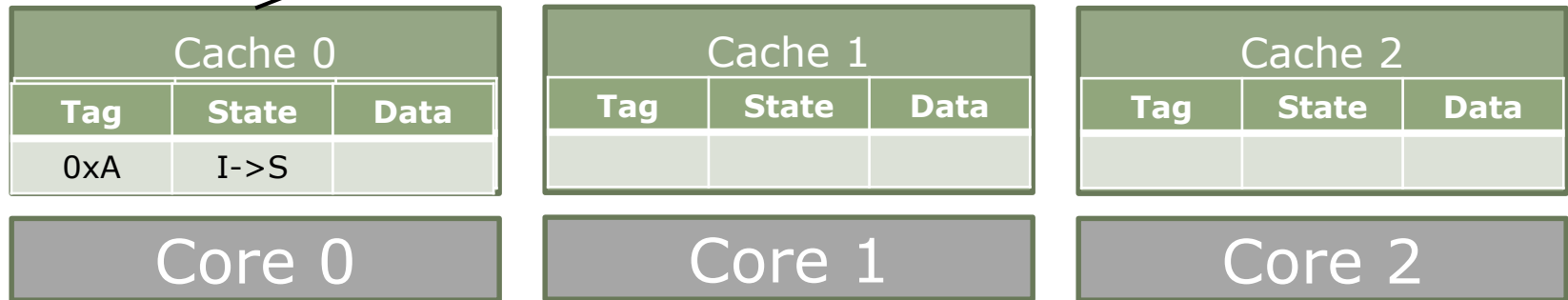

**1** LD 0xA

# MSI Directory Protocol Example

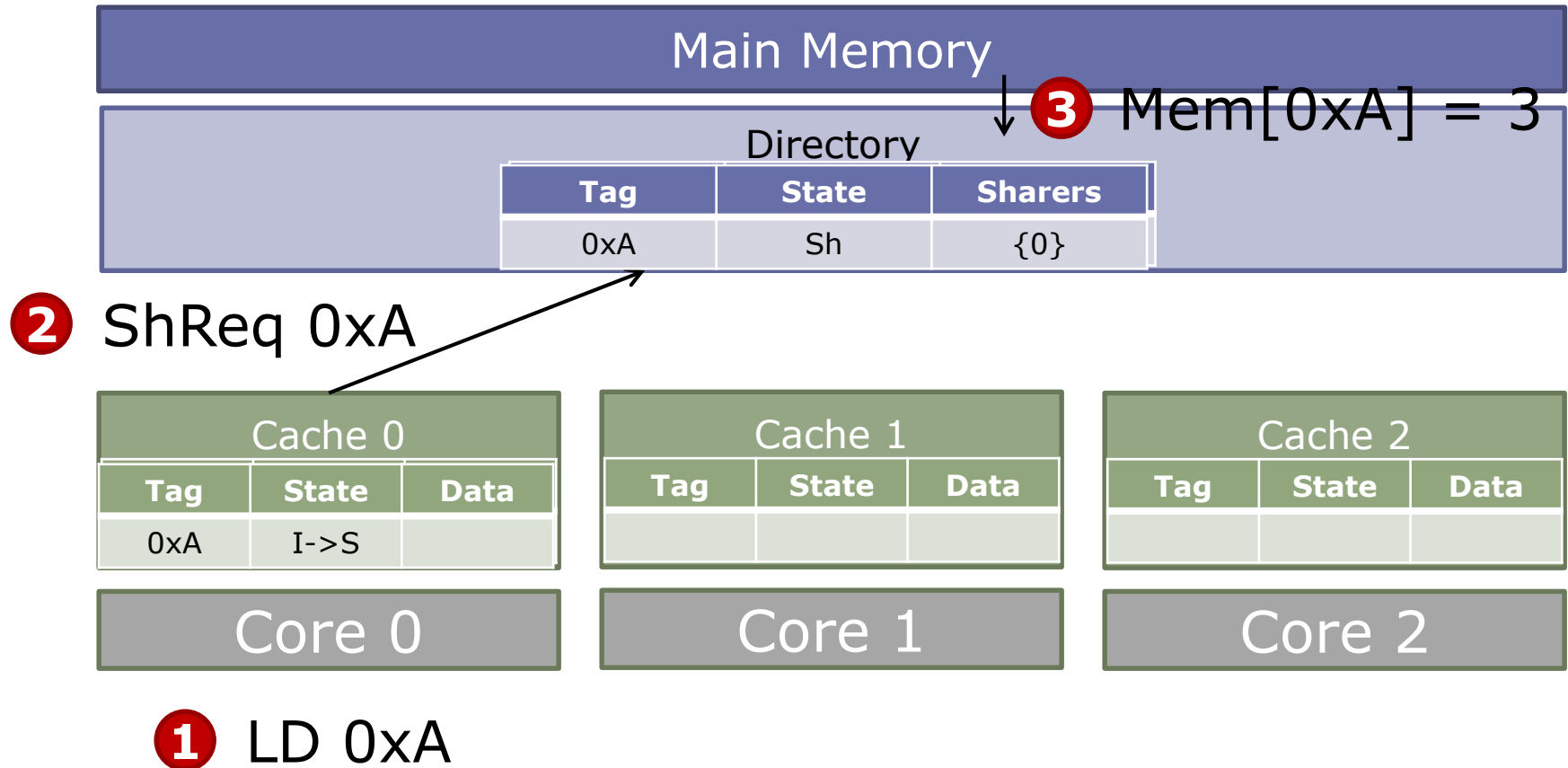



# MSI Directory Protocol Example

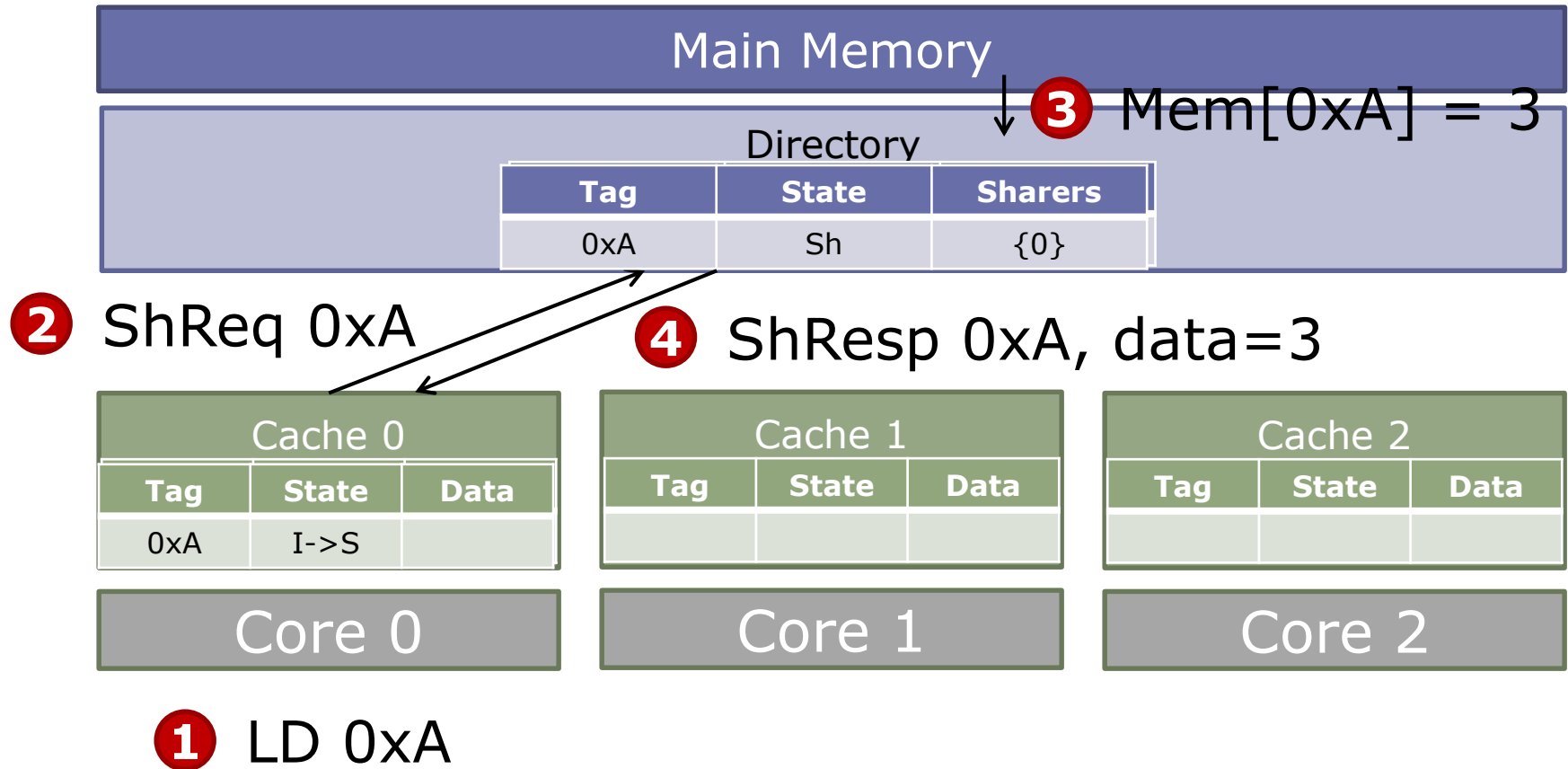

# MSI Directory Protocol Example

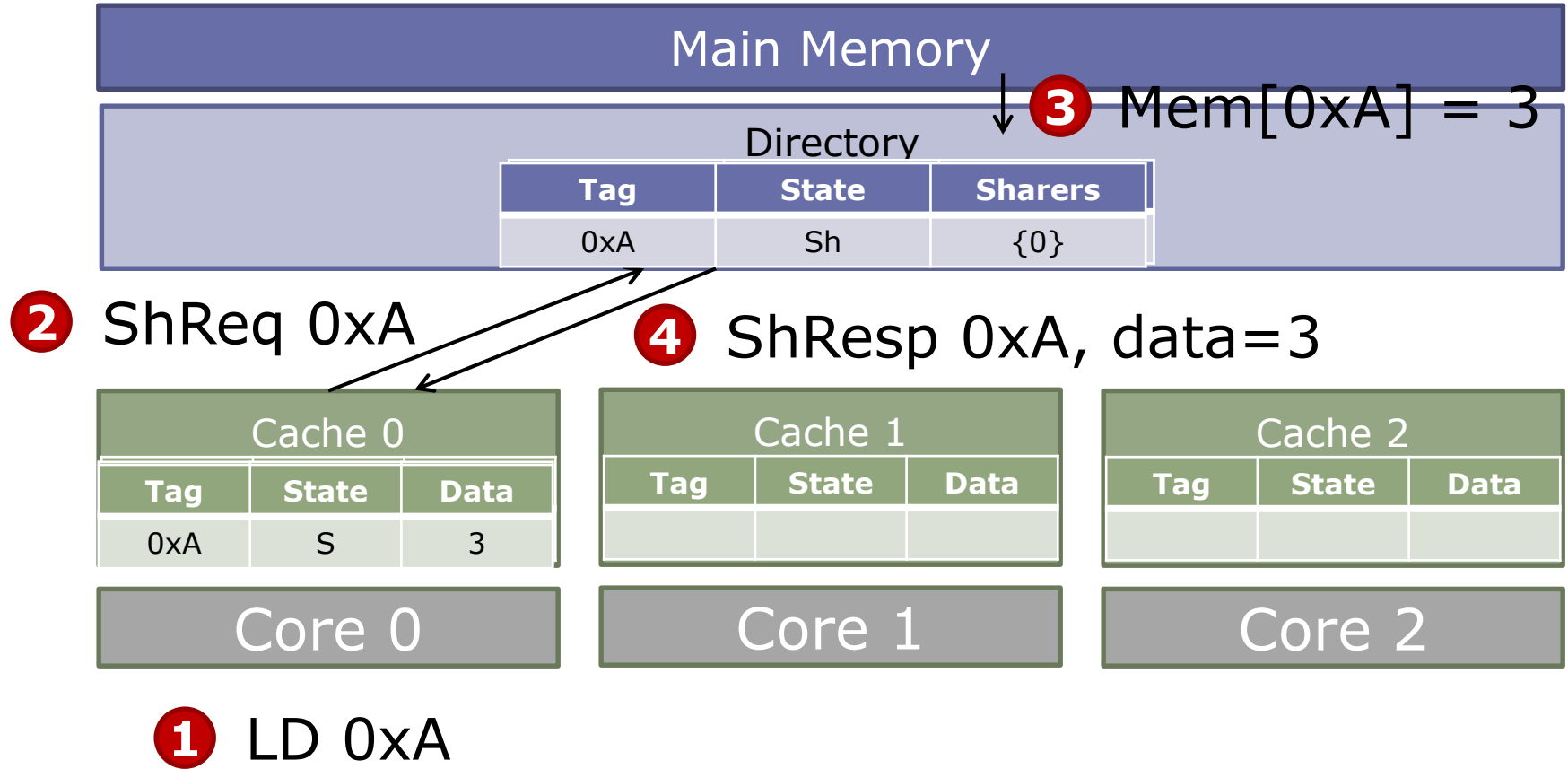

# MSI Directory Protocol Example

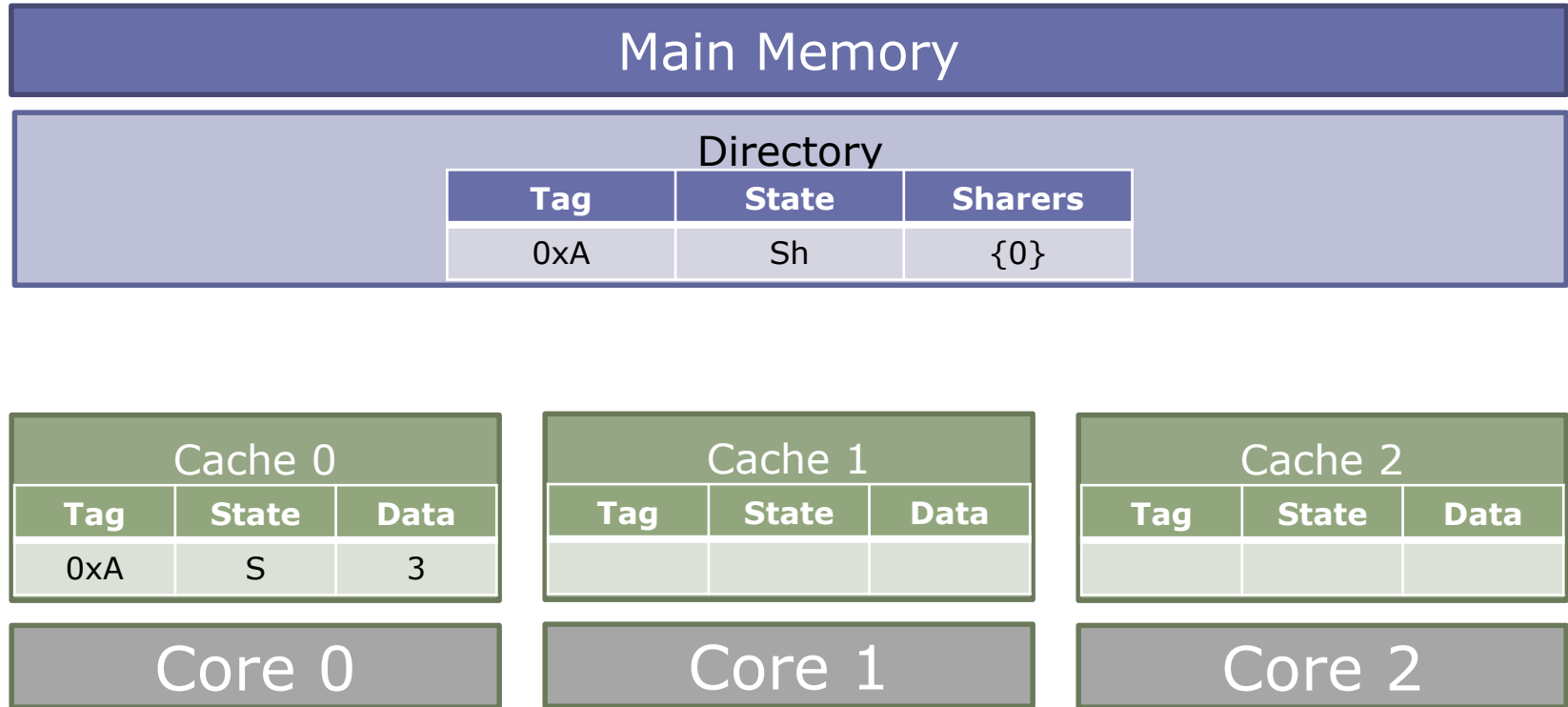

# MSI Directory Protocol Example

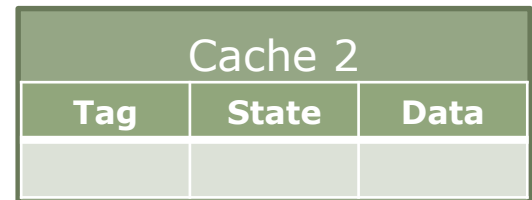
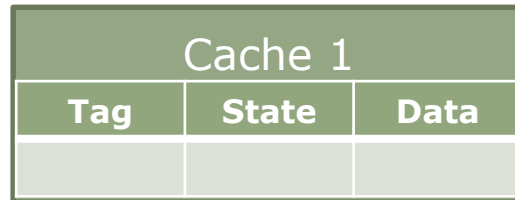
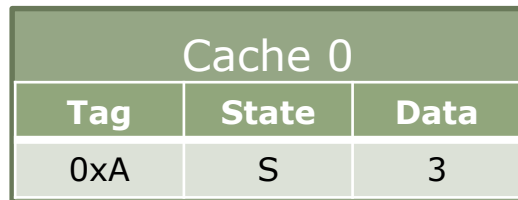
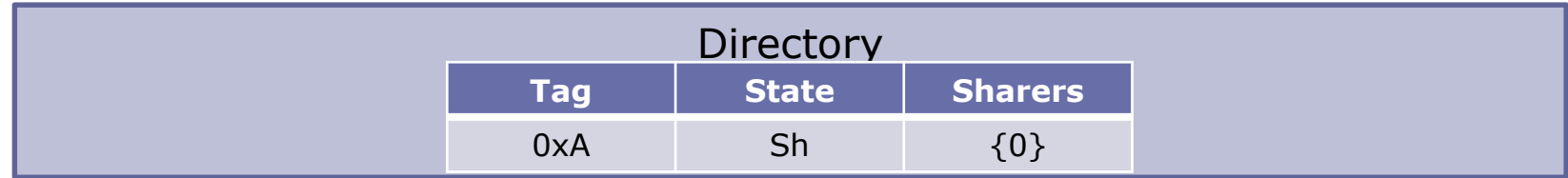

**1** LD 0xA

# MSI Directory Protocol Example

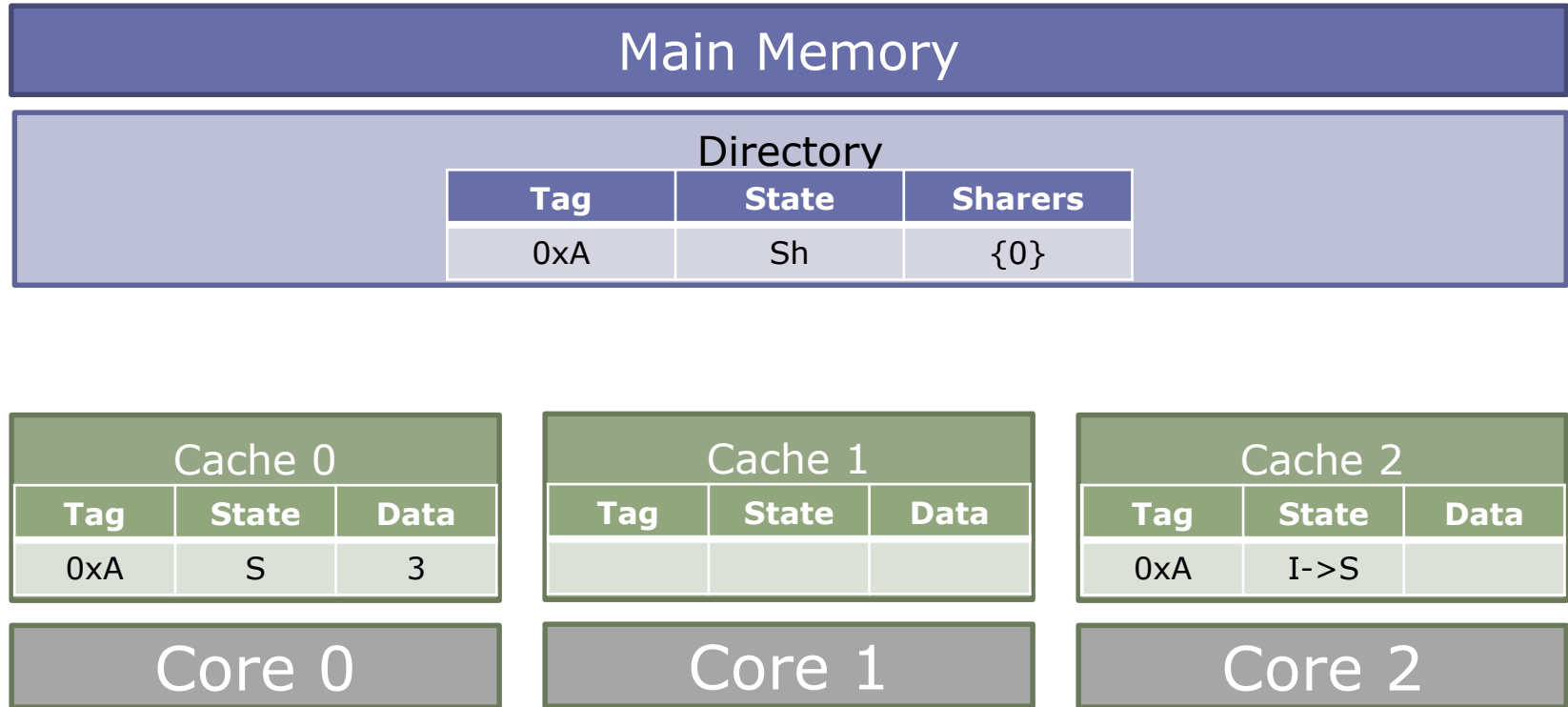

**1** LD 0xA

# MSI Directory Protocol Example

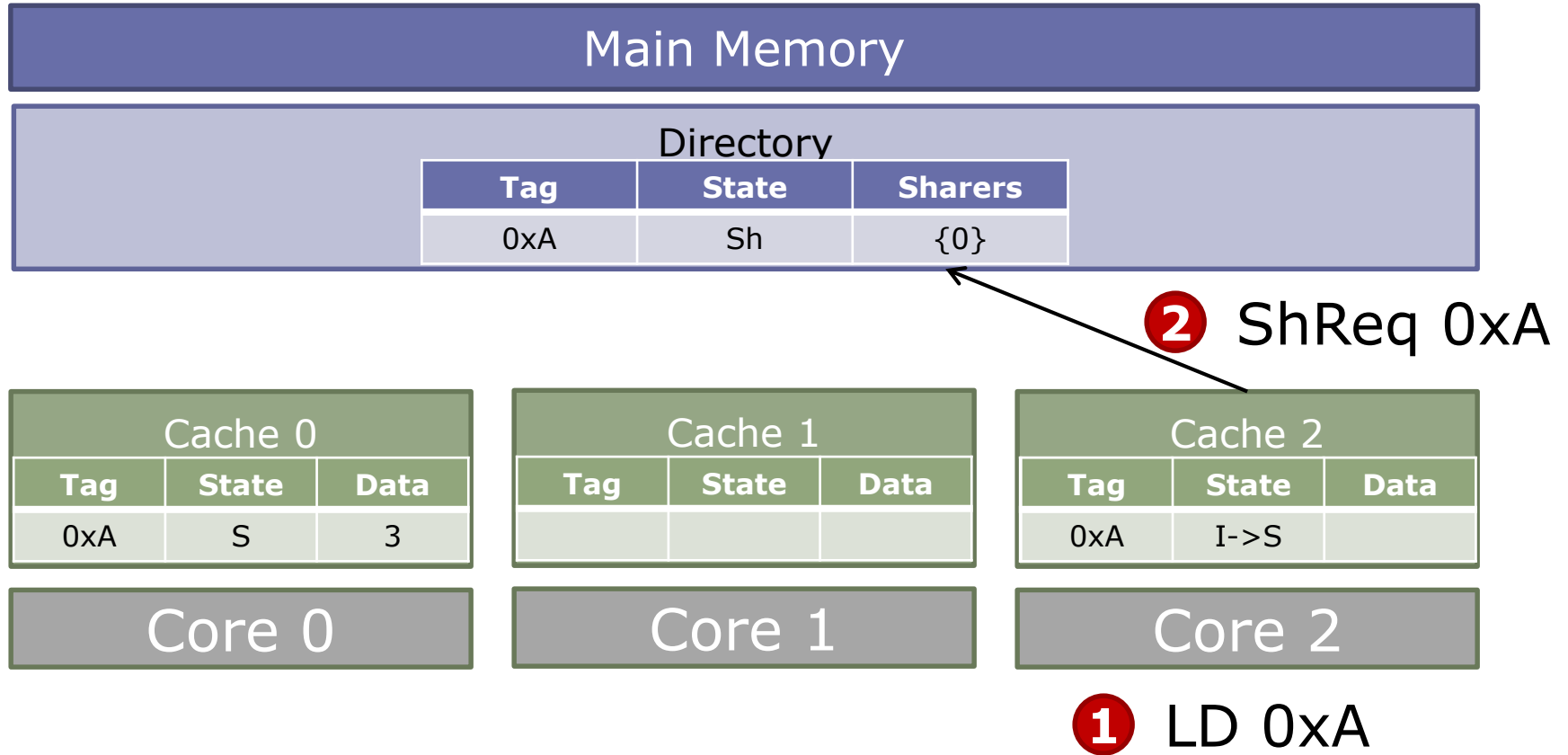

# MSI Directory Protocol Example

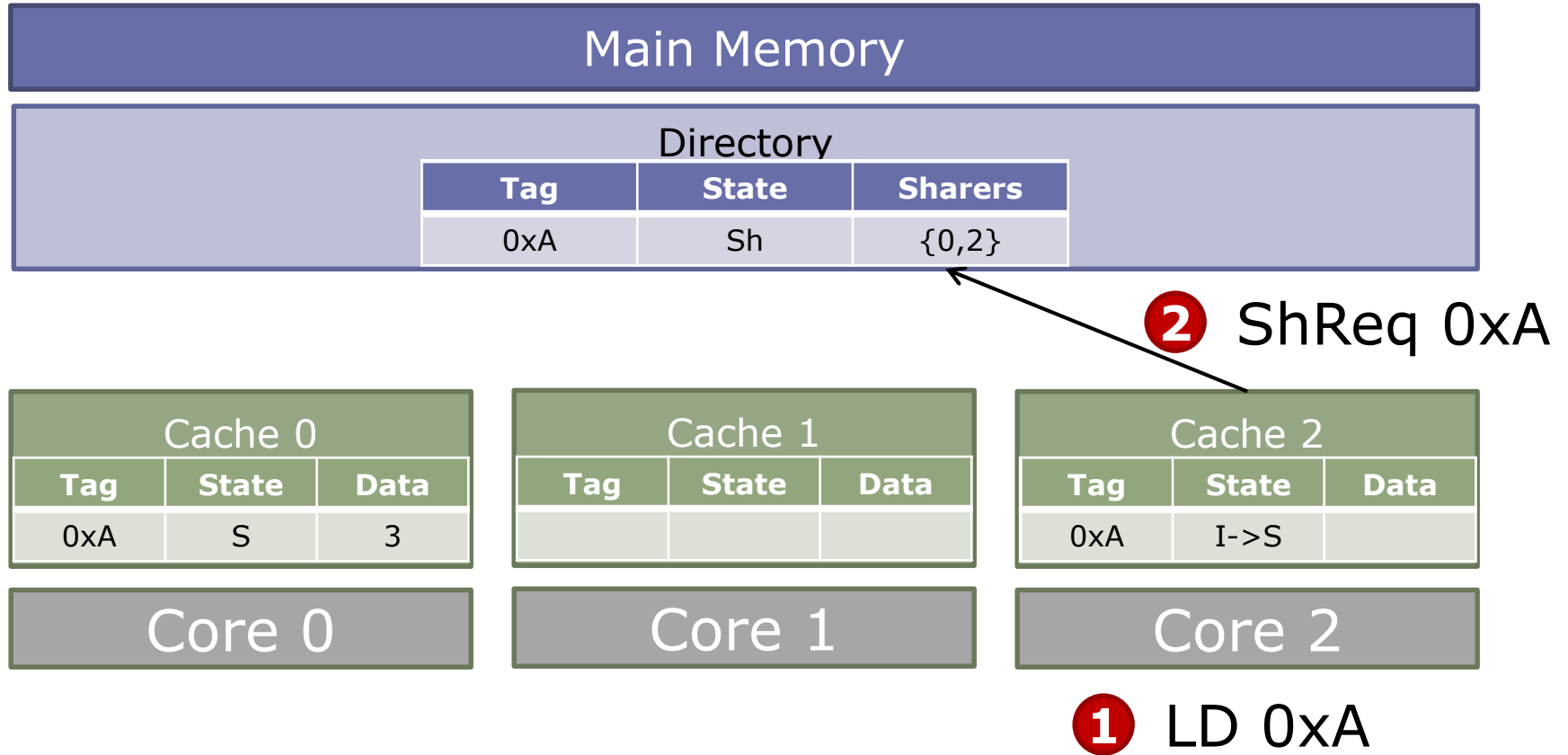

# MSI Directory Protocol Example

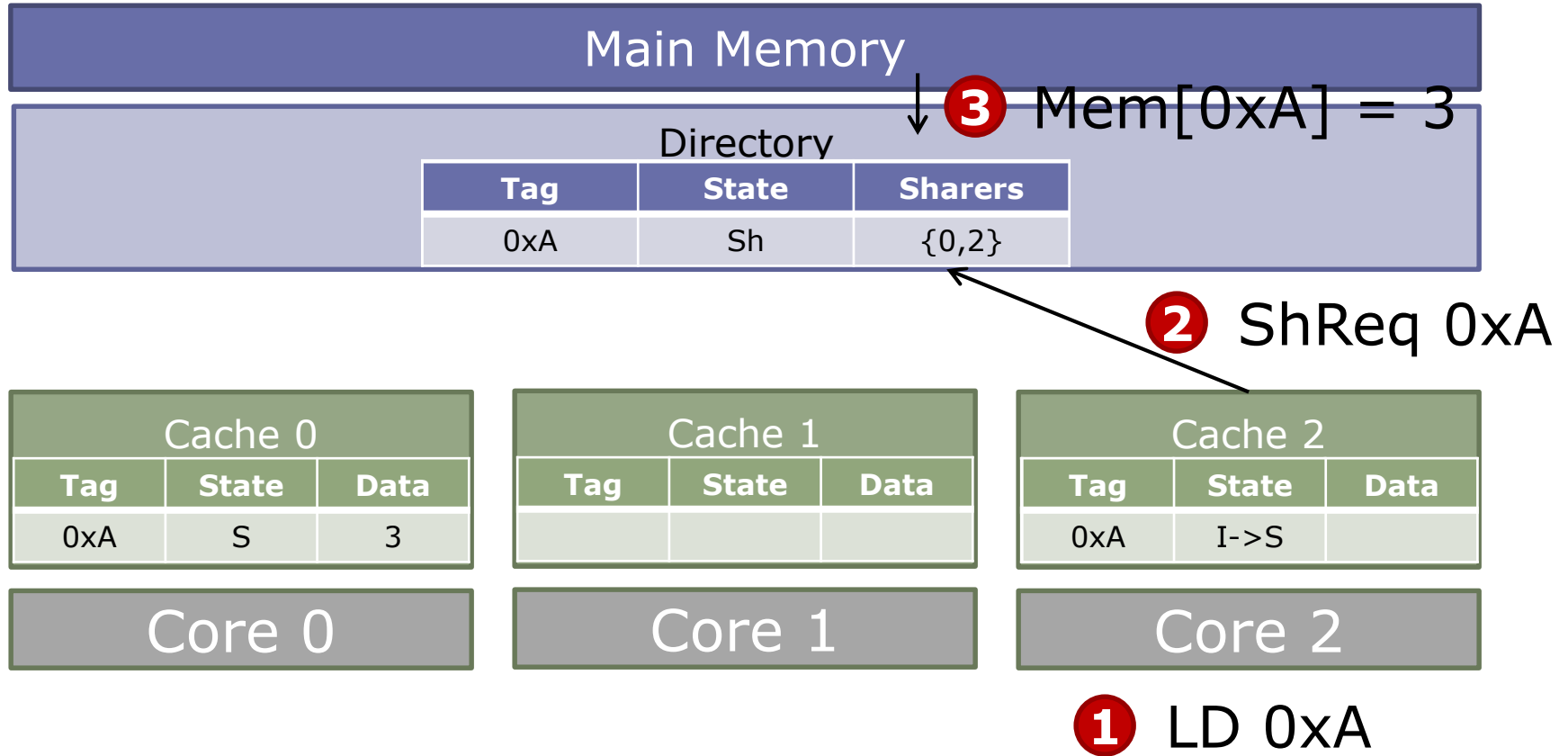



# MSI Directory Protocol Example

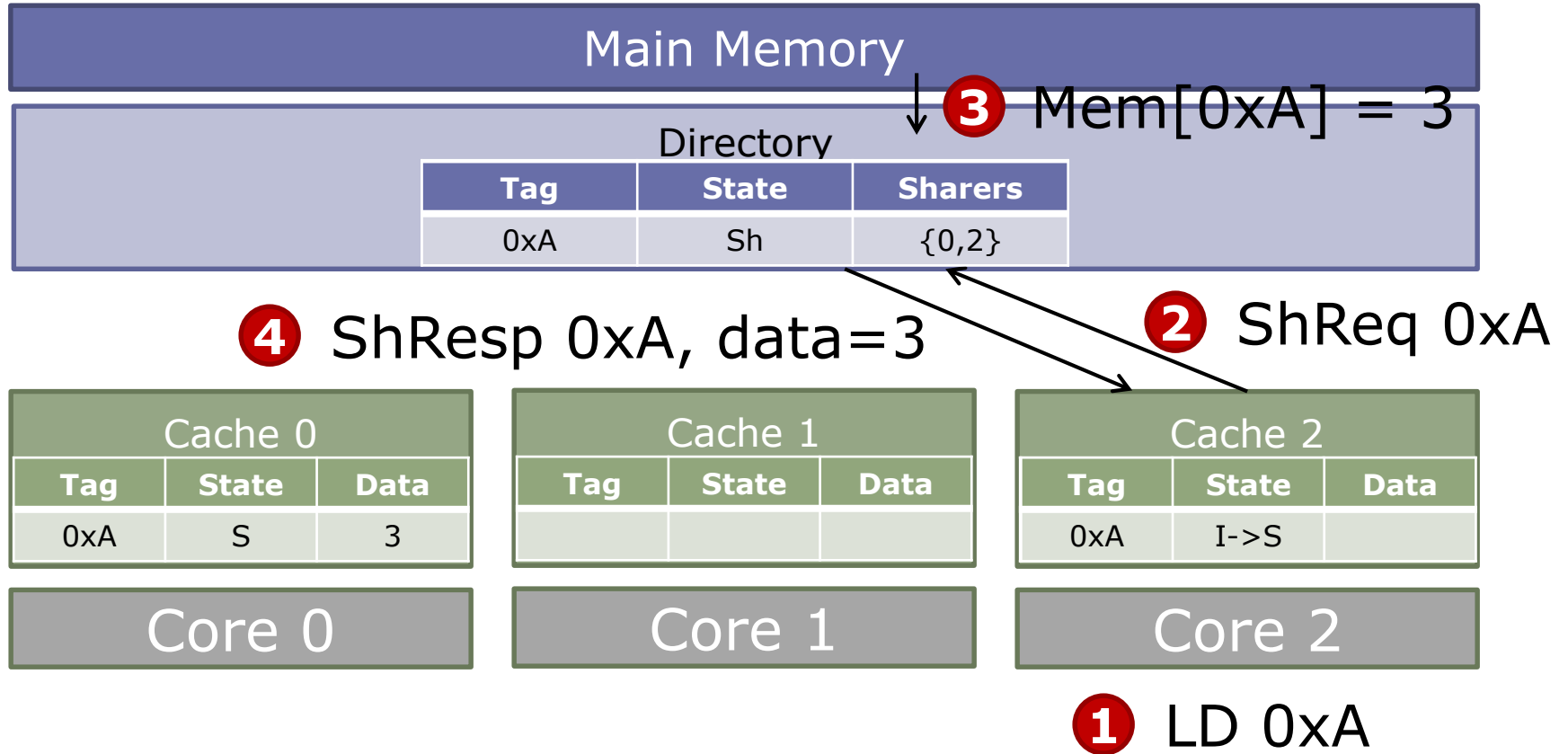

# MSI Directory Protocol Example

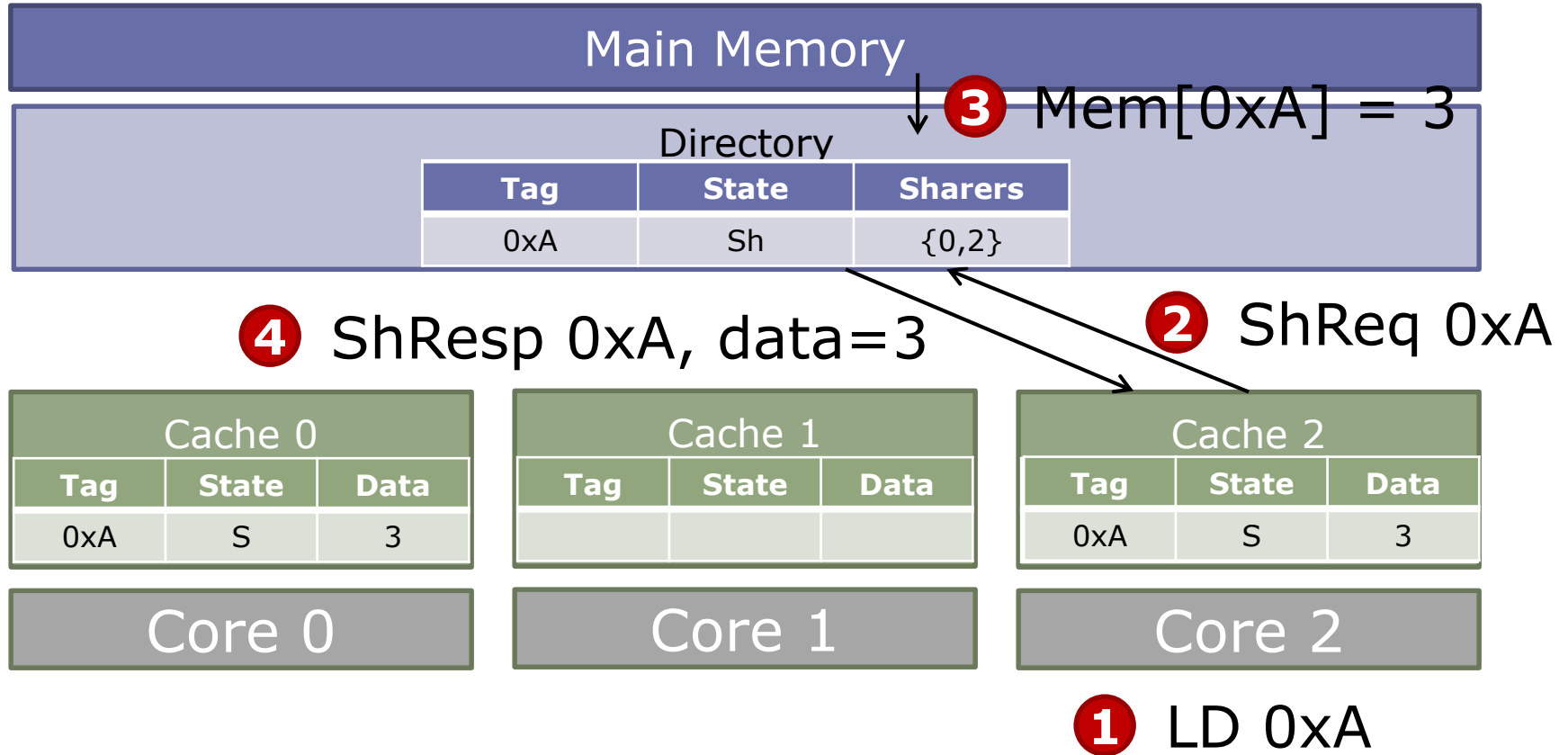

# MSI Directory Protocol Example

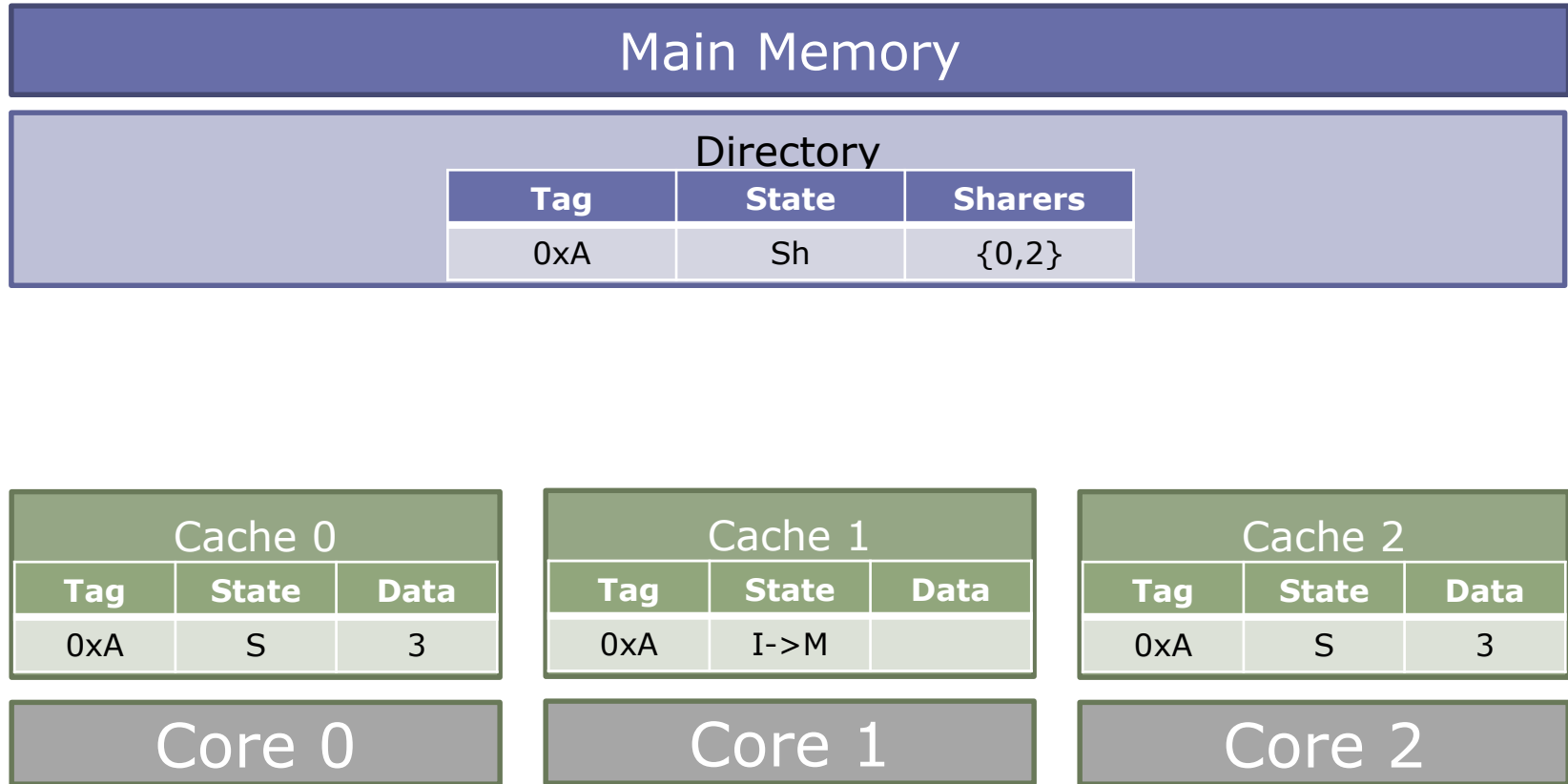

**1** ST 0xA

# MSI Directory Protocol Example

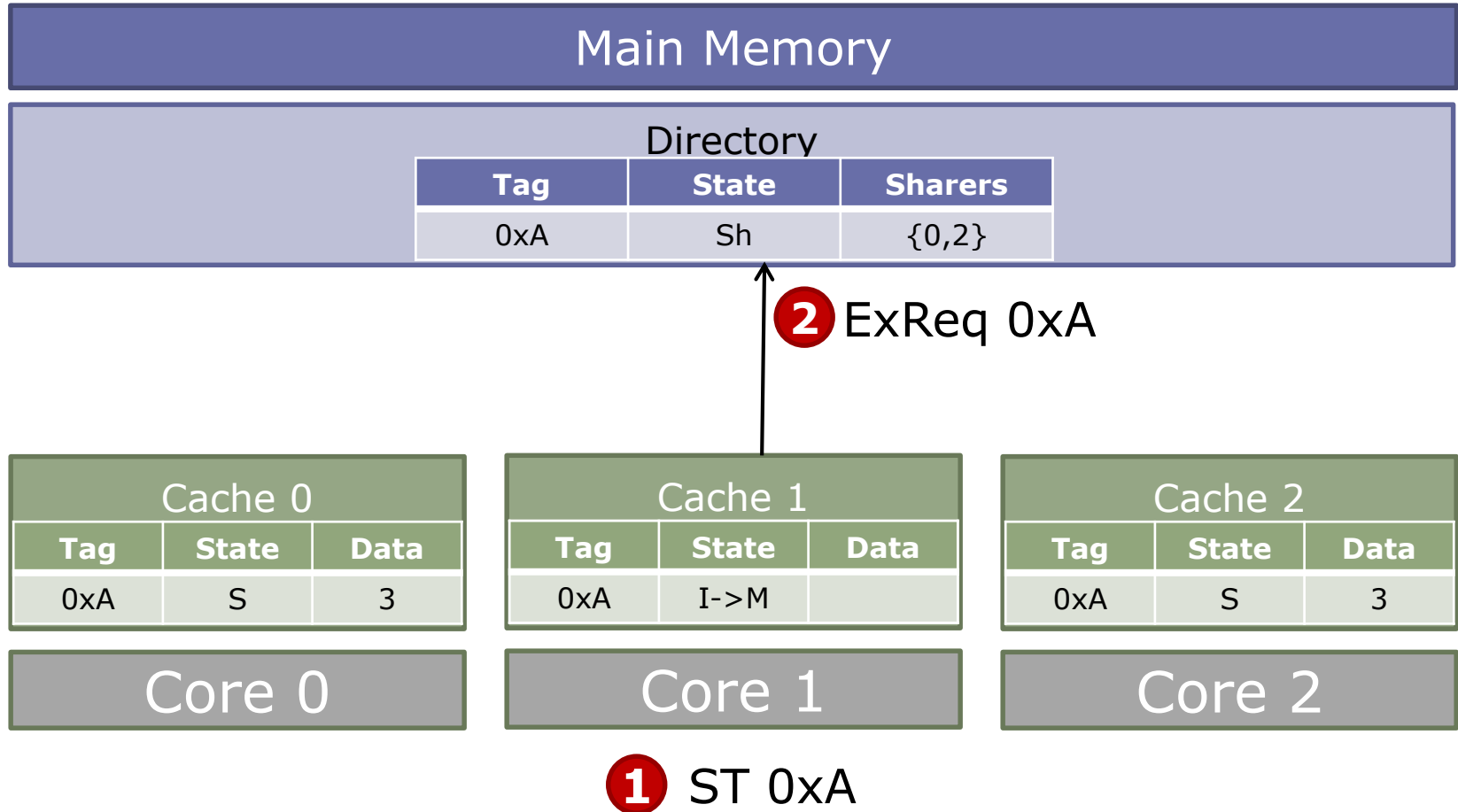

# MSI Directory Protocol Example

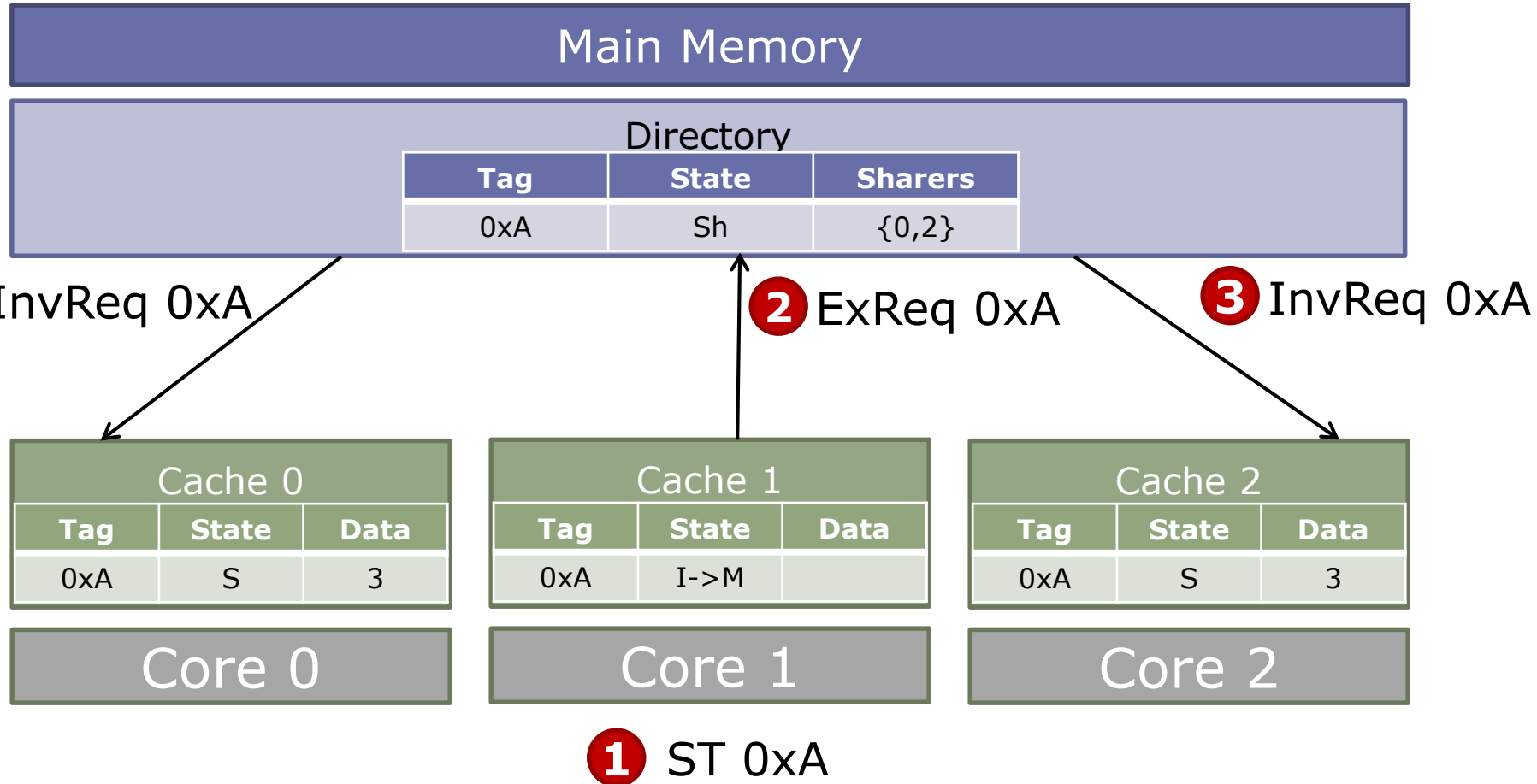

# MSI Directory Protocol Example

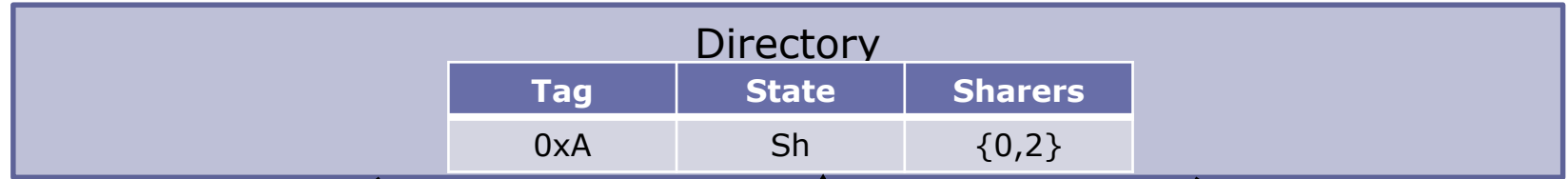

3 InvReq 0xA     
 2 ExReq 0xA     
 3 InvReq 0xA

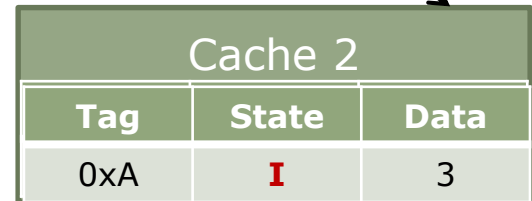
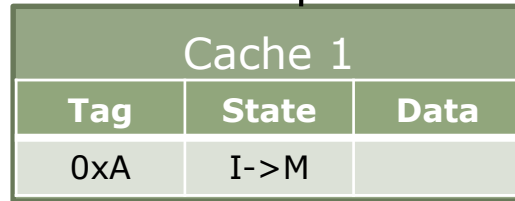
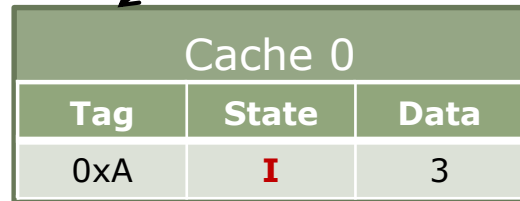

1 ST 0xA

# MSI Directory Protocol Example

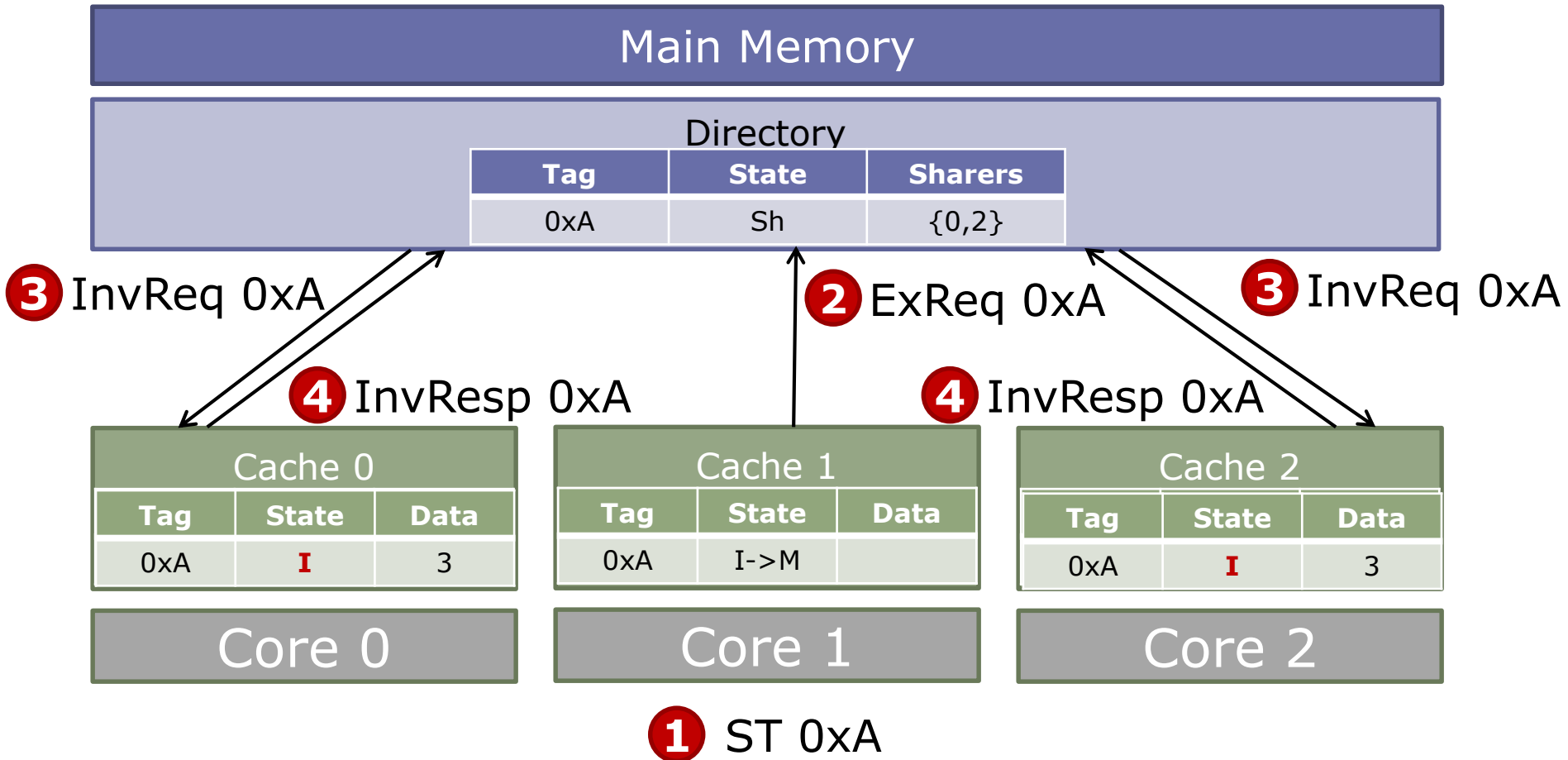

# MSI Directory Protocol Example

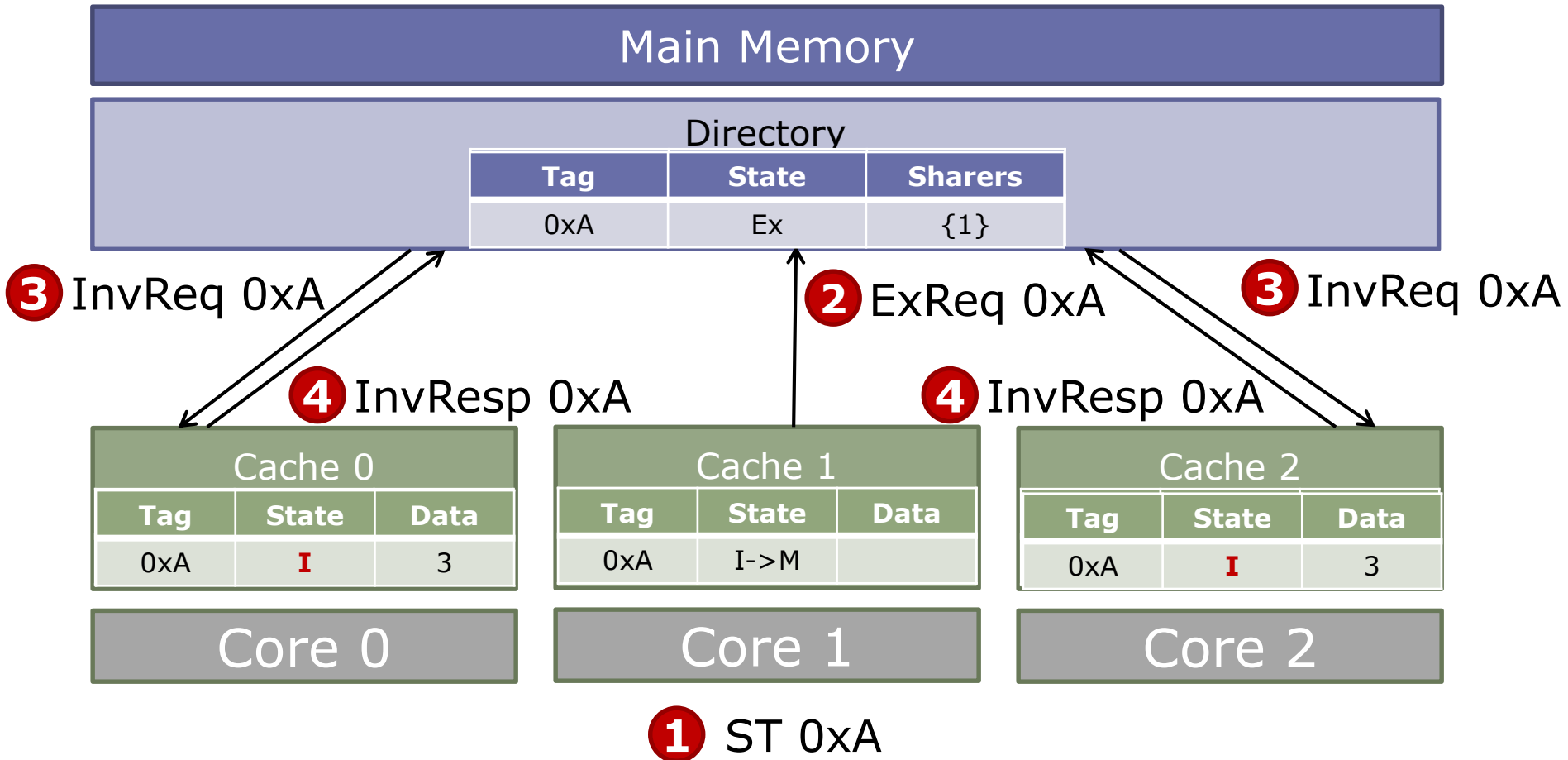



# MSI Directory Protocol Example

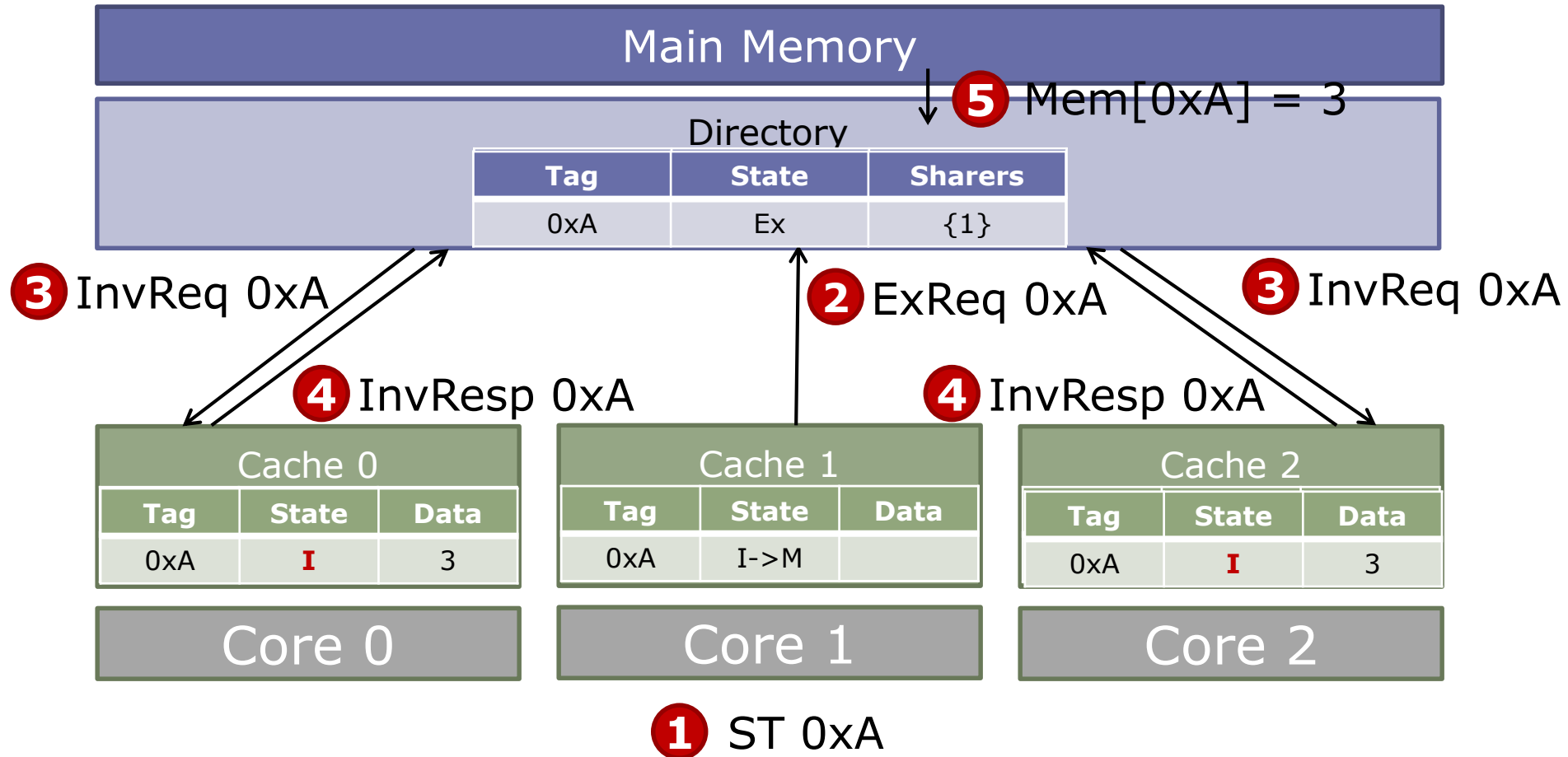



# MSI Directory Protocol Example

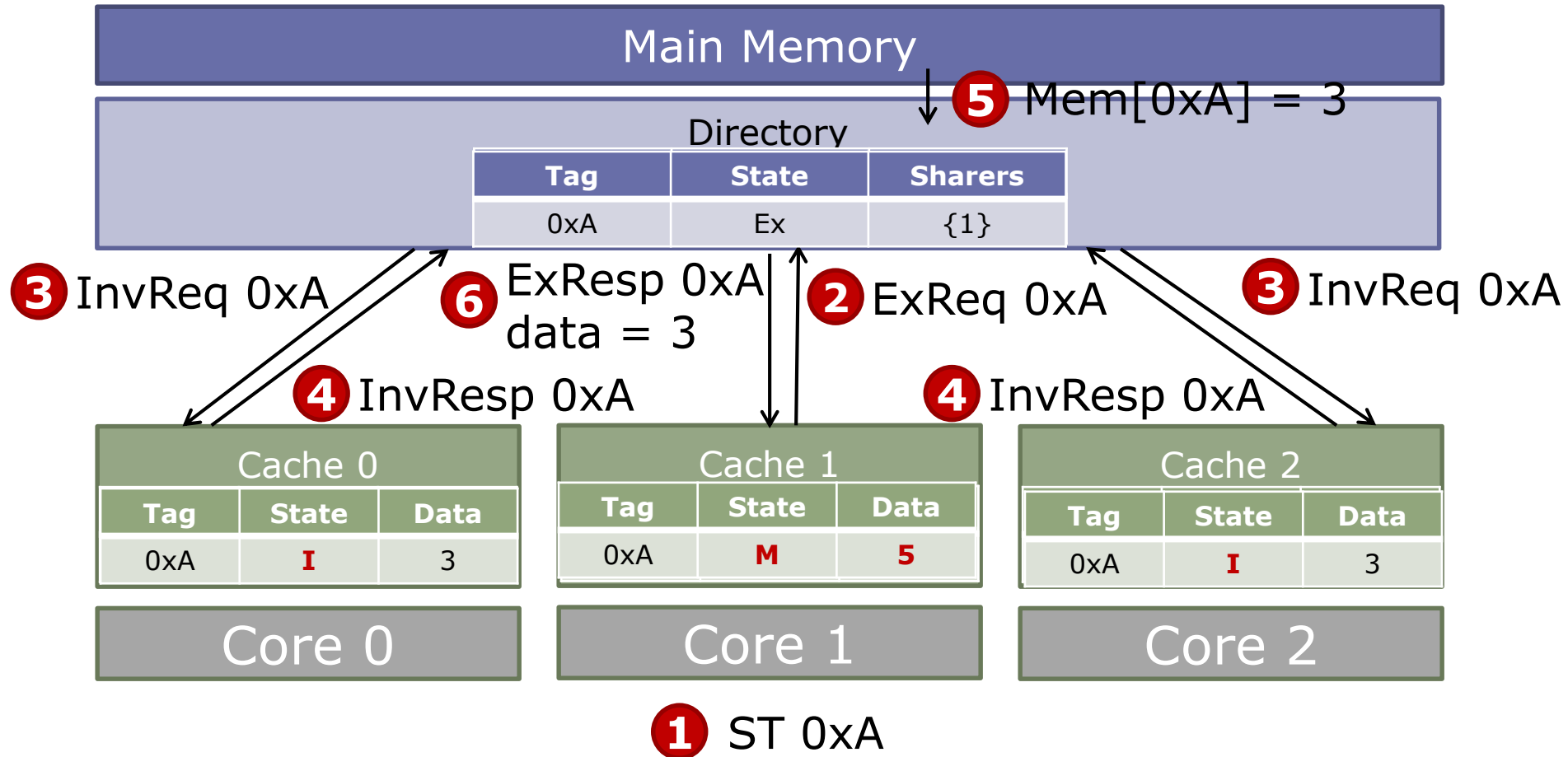

# MSI Directory Protocol Example

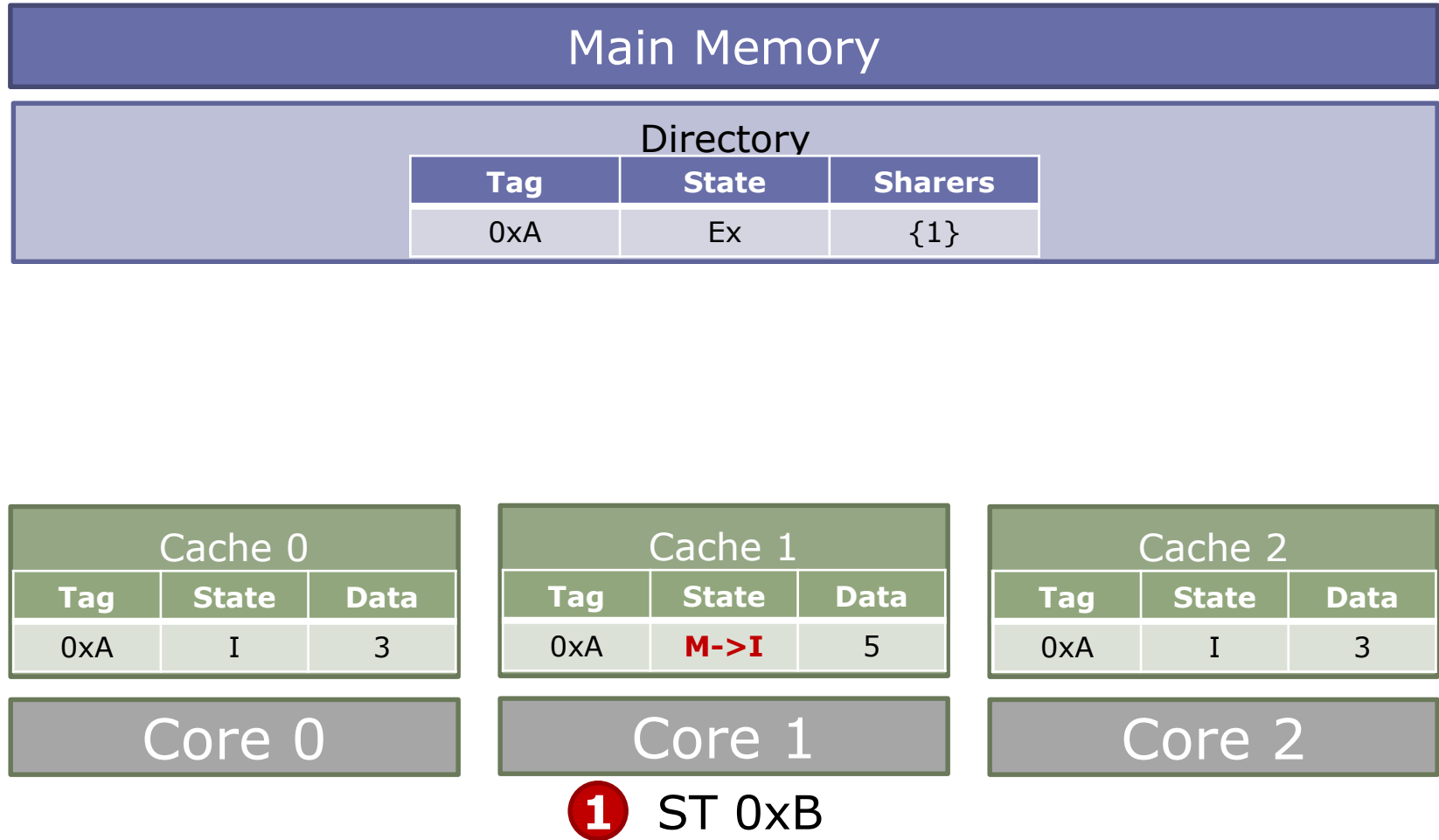

# MSI Directory Protocol Example

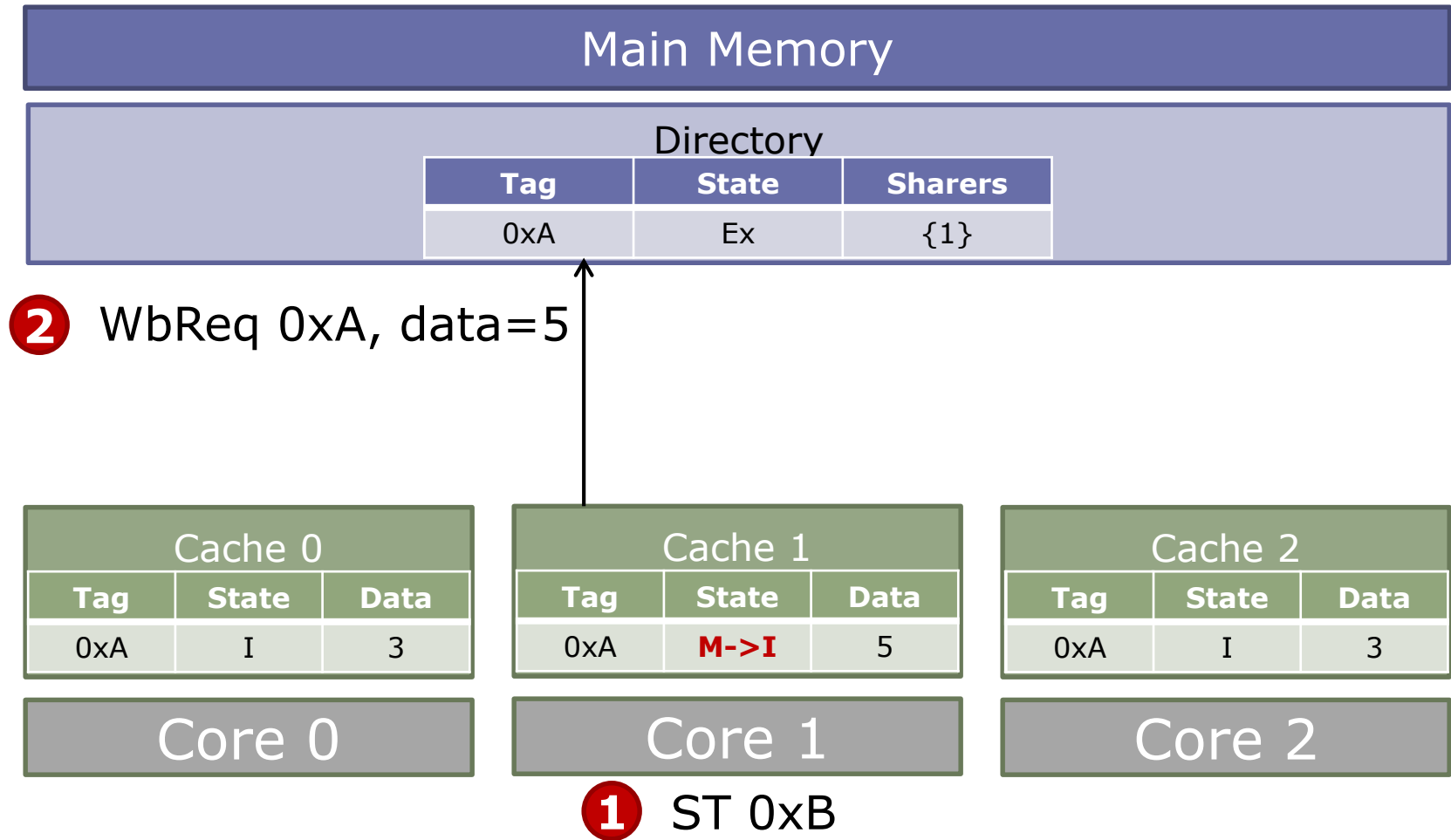

# MSI Directory Protocol Example

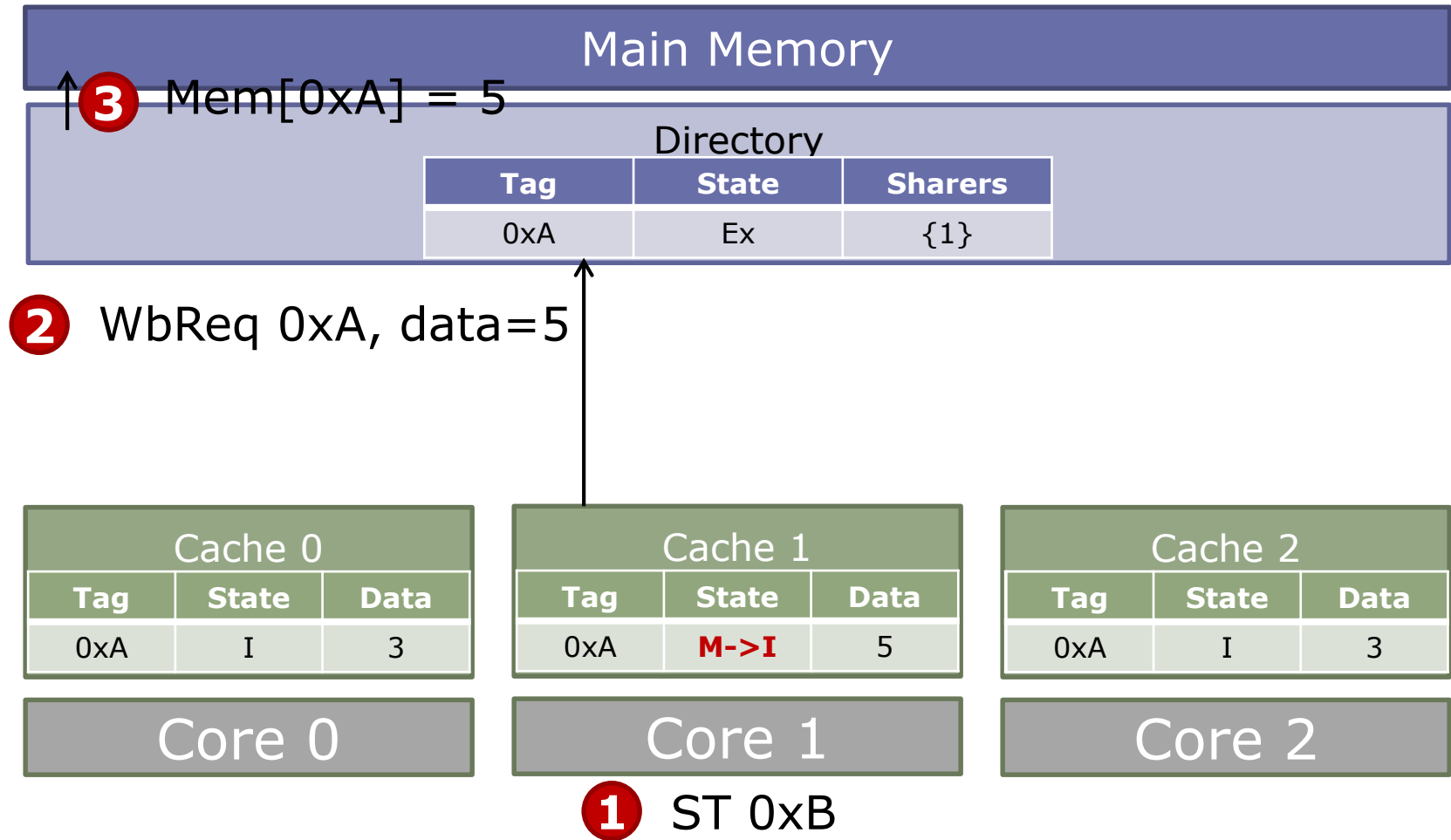

# MSI Directory Protocol Example

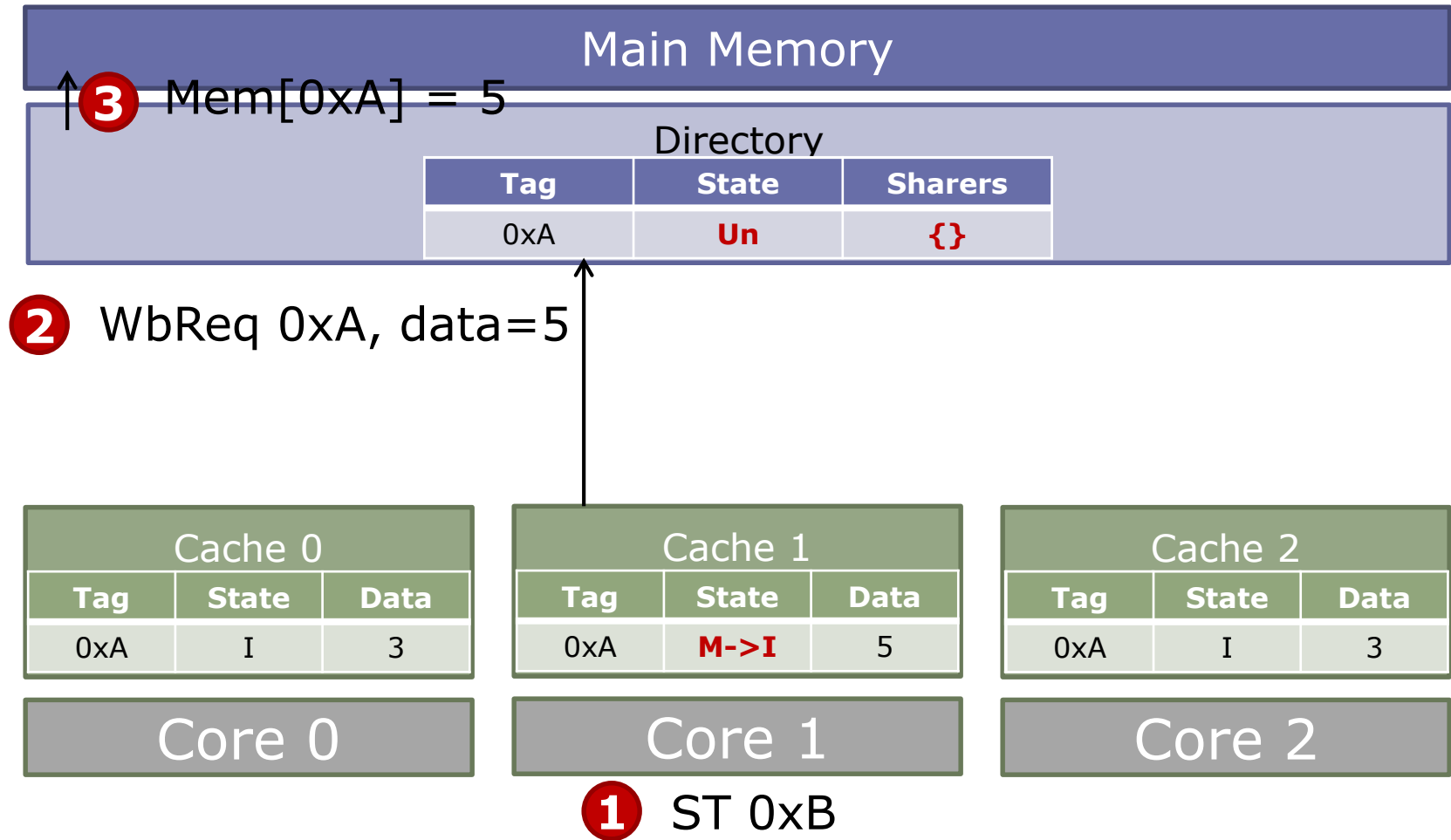

# MSI Directory Protocol Example

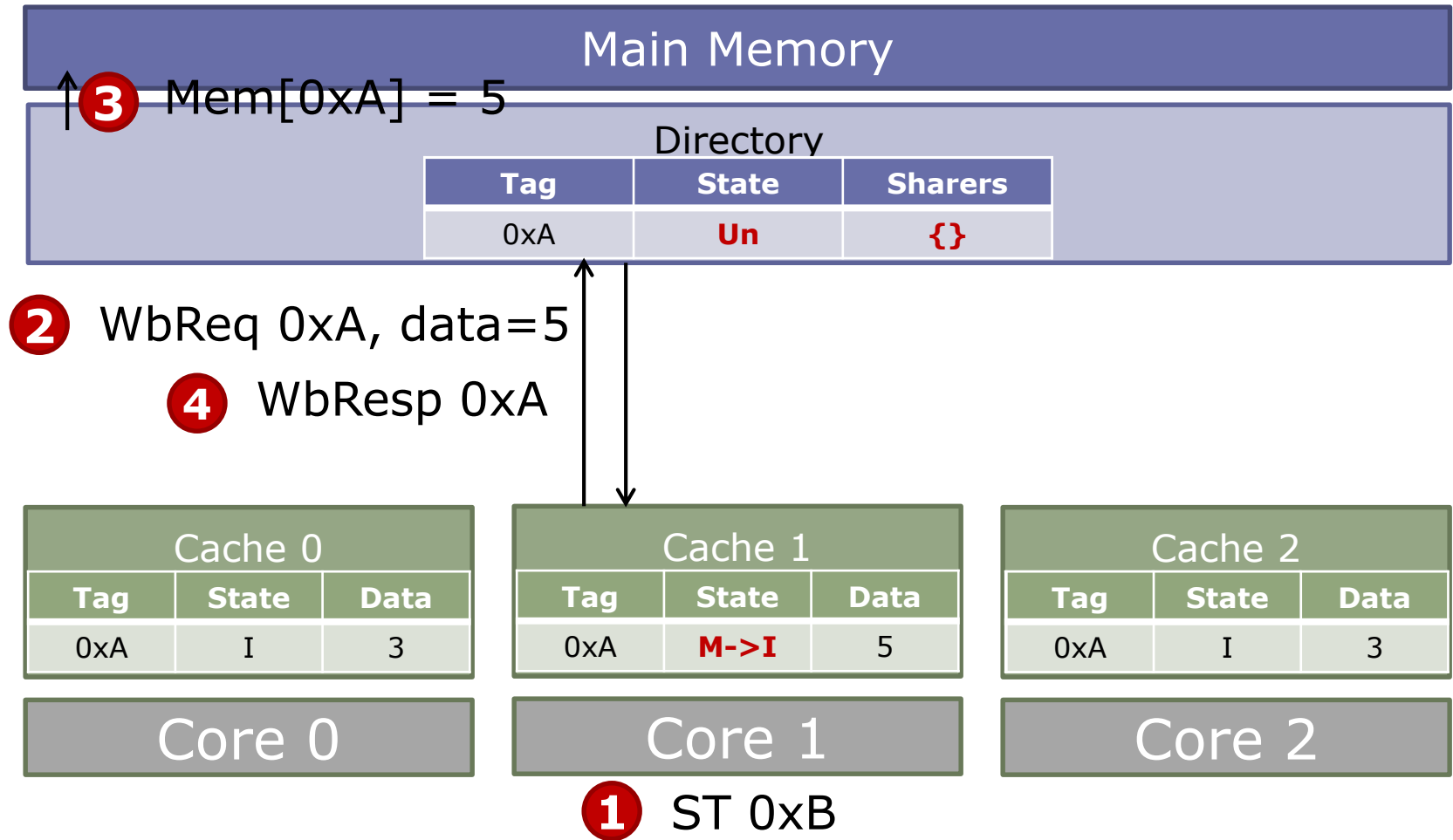



# MSI Directory Protocol Example

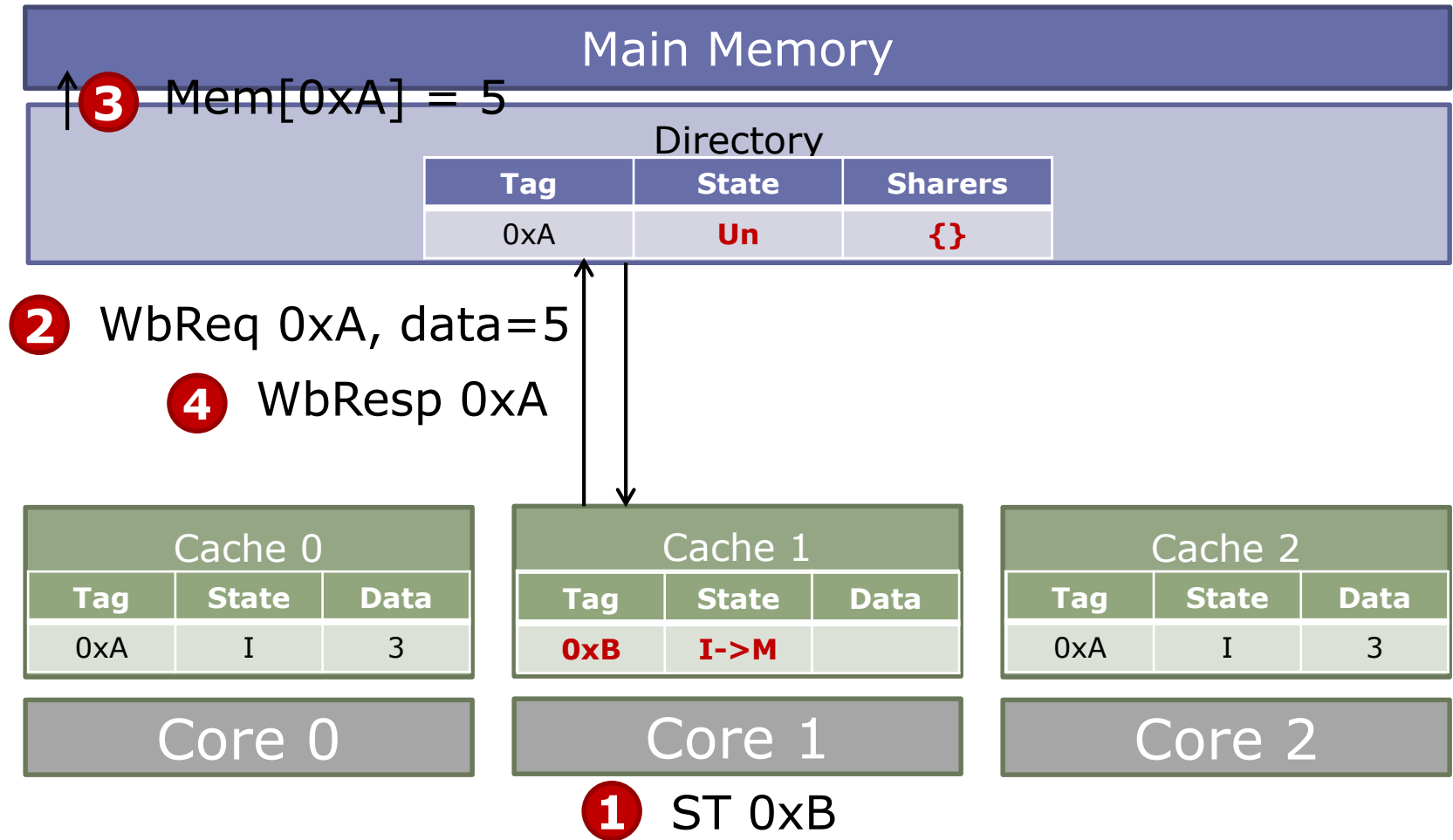

# MSI Directory Protocol Example

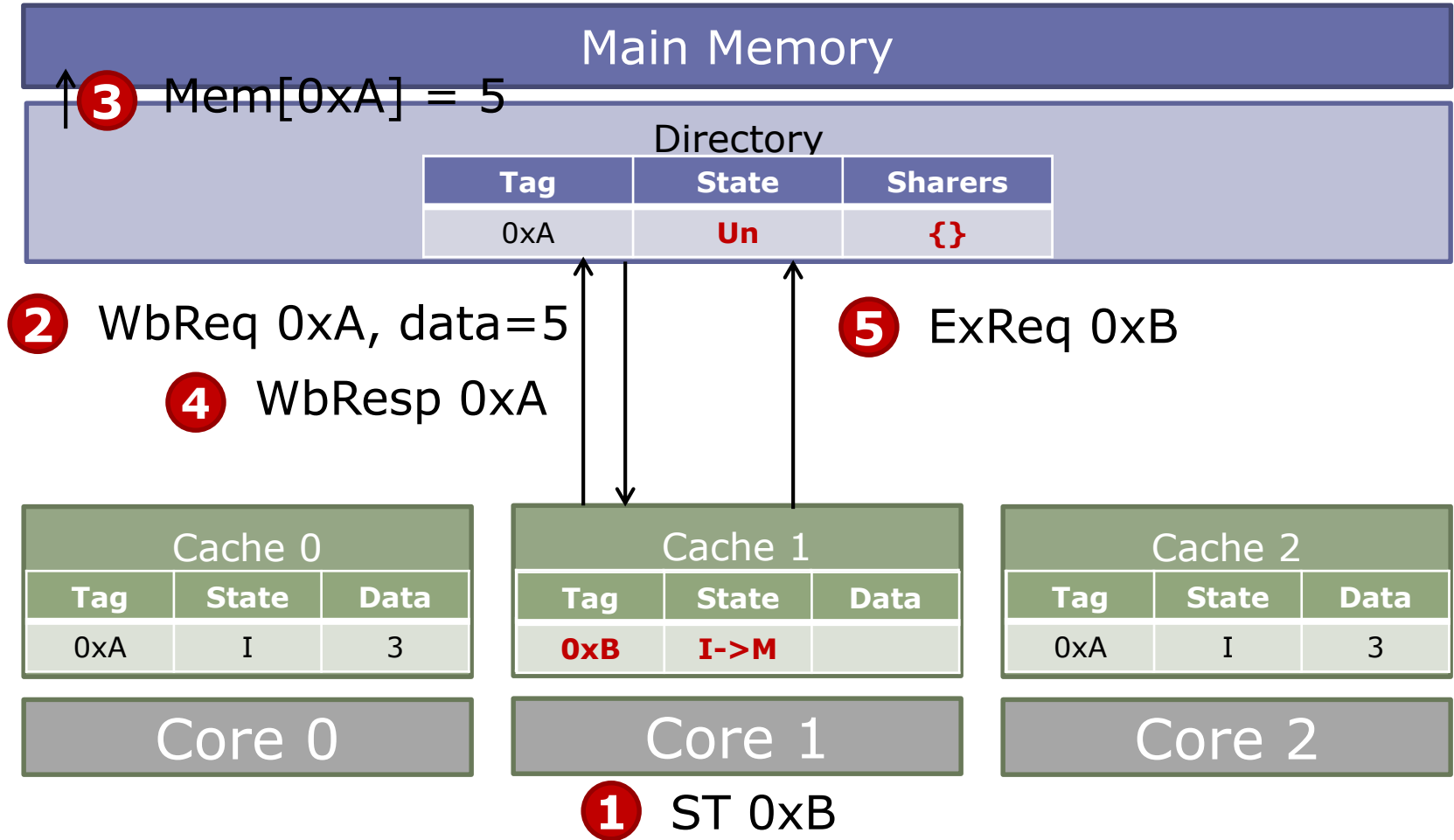

# MSI Directory Protocol Example

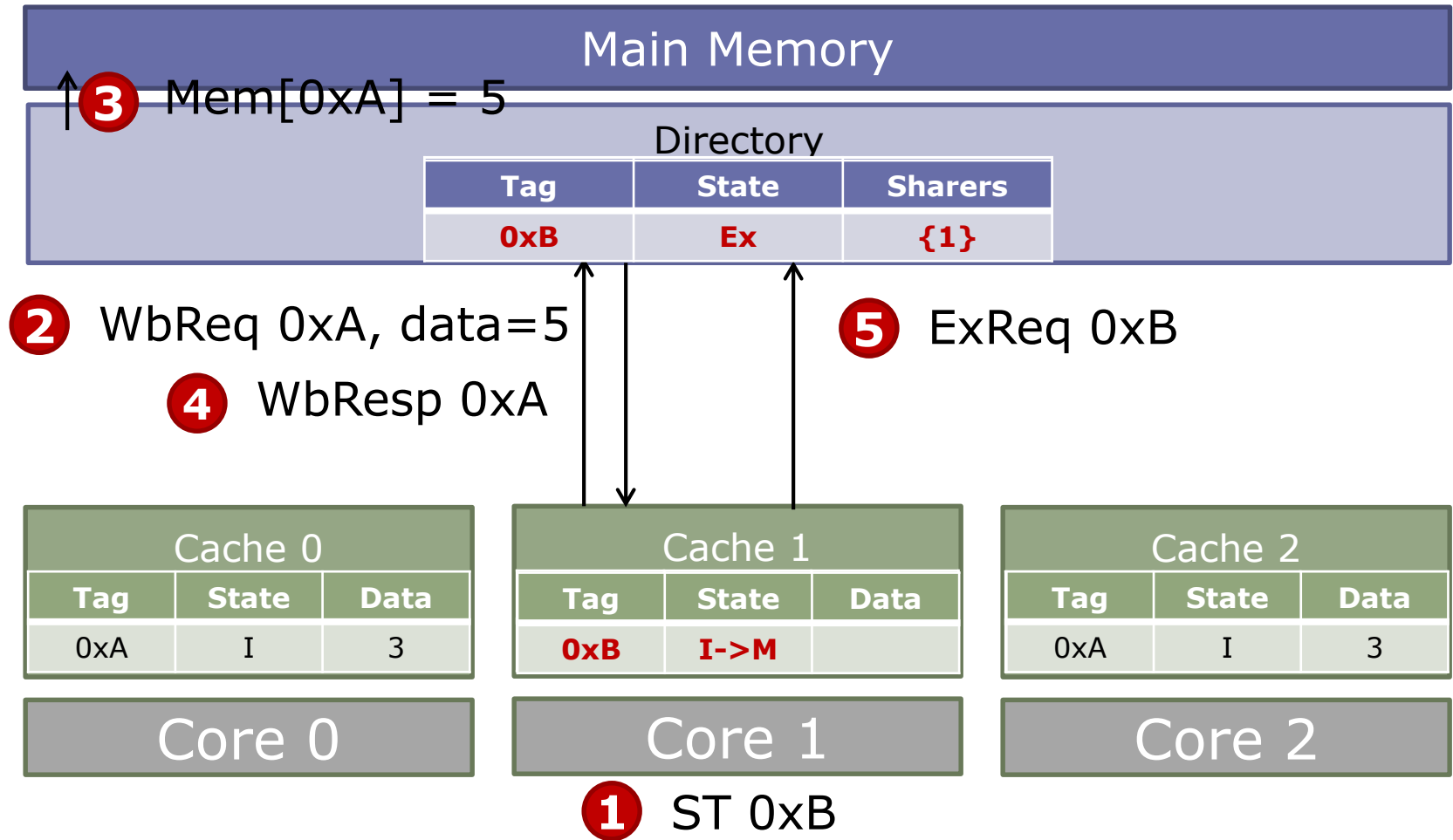

# MSI Directory Protocol Example

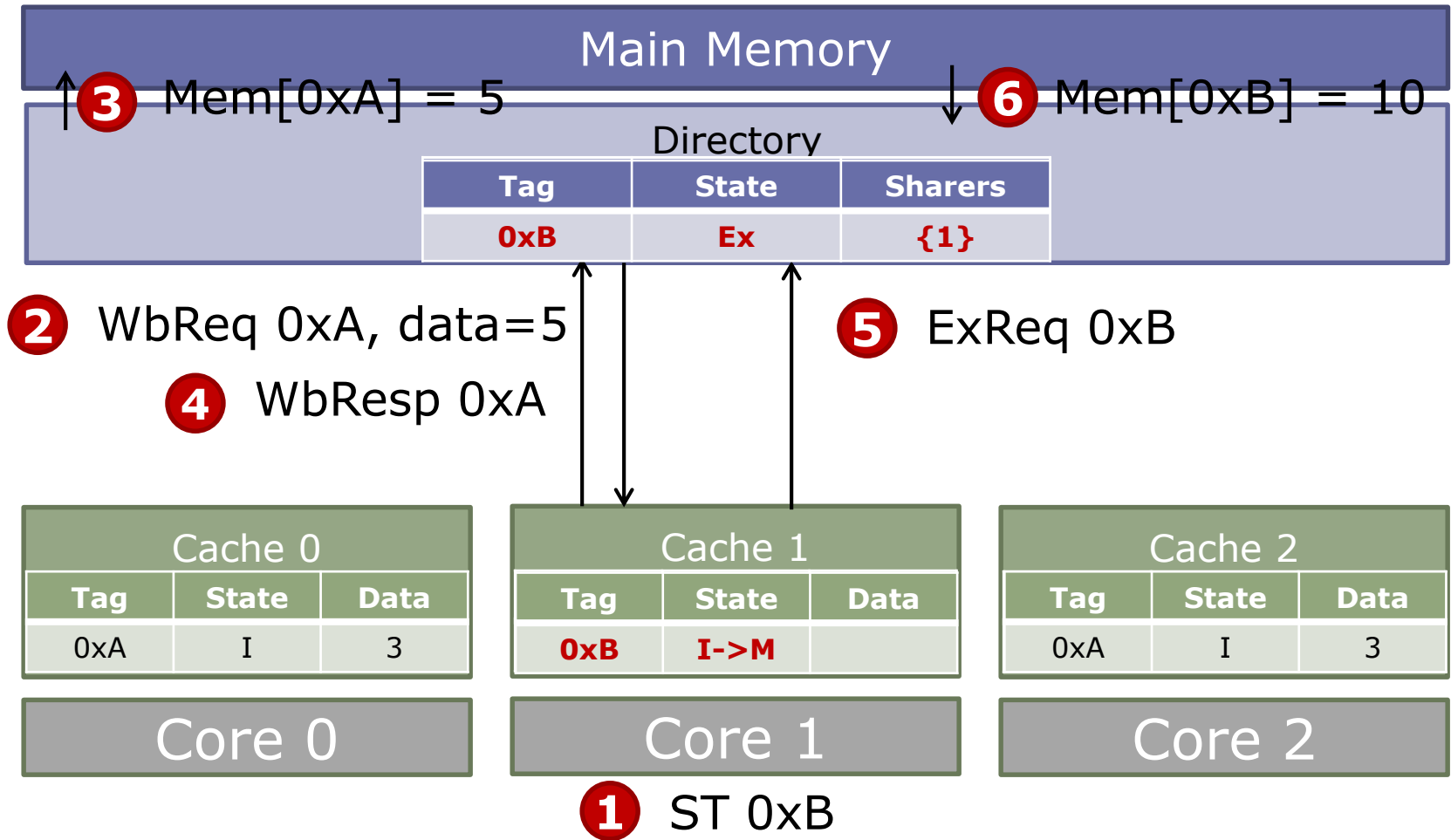

# MSI Directory Protocol Example

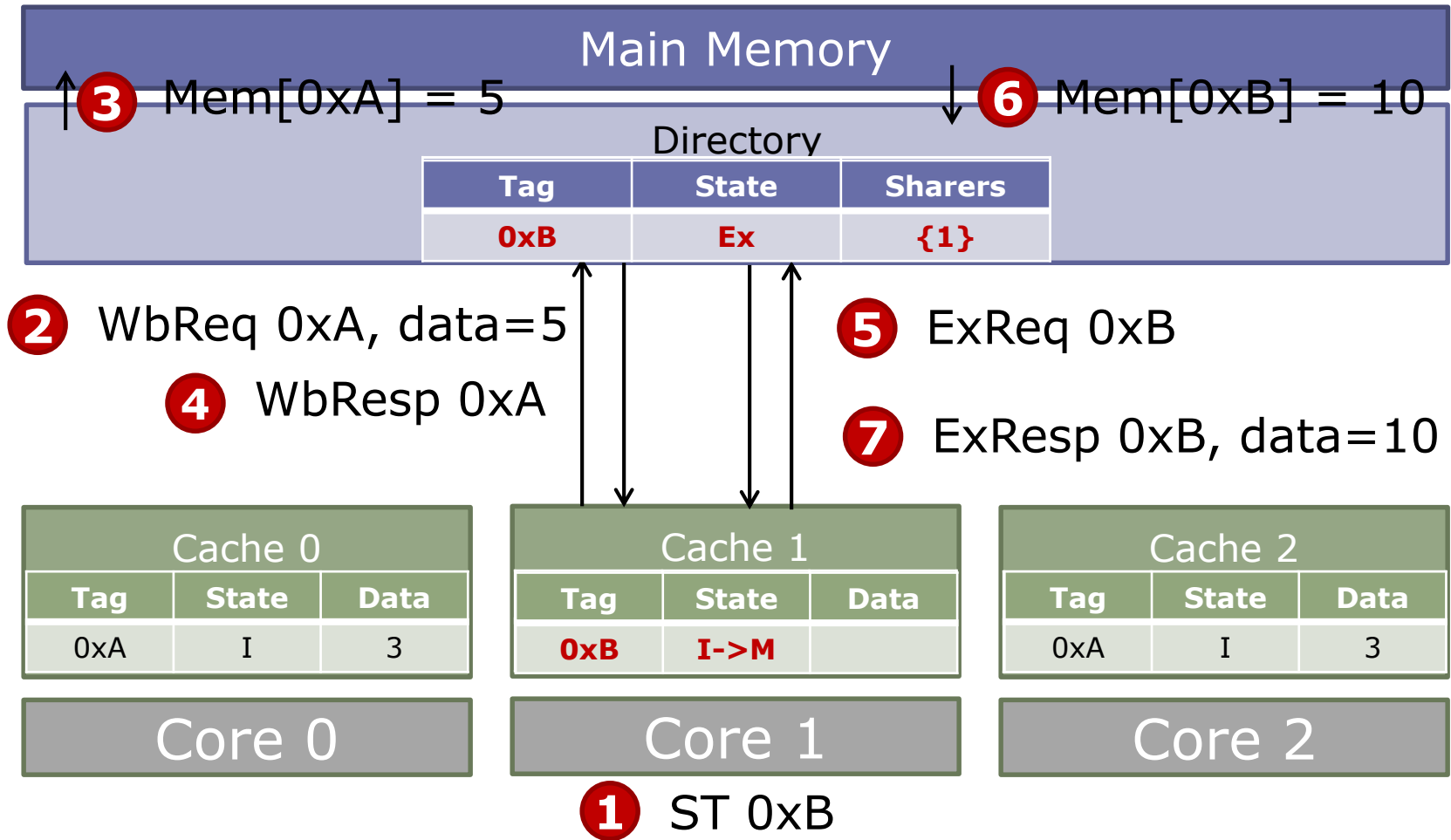

# MSI Directory Protocol Example

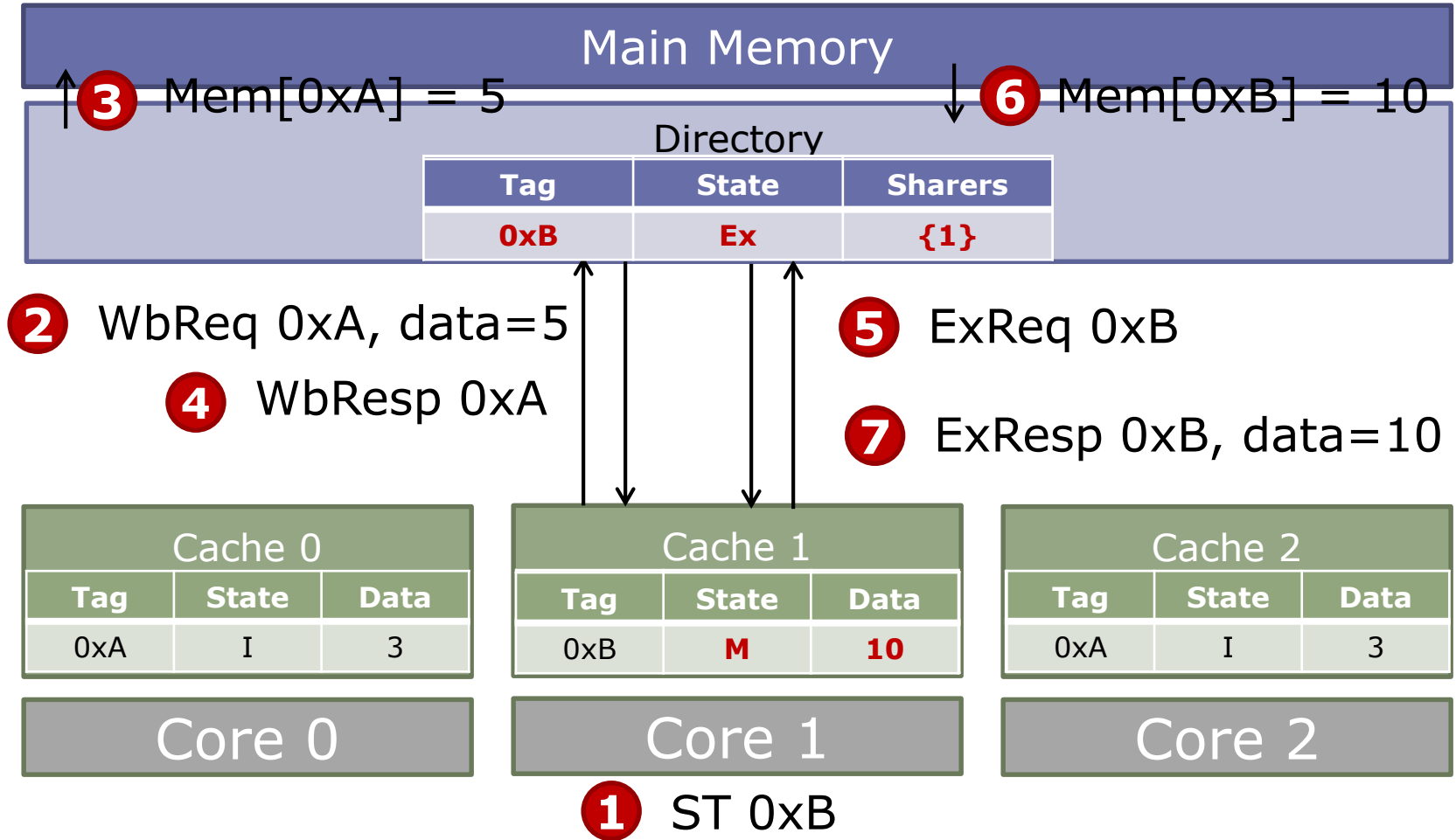

# MSI Directory Protocol Example

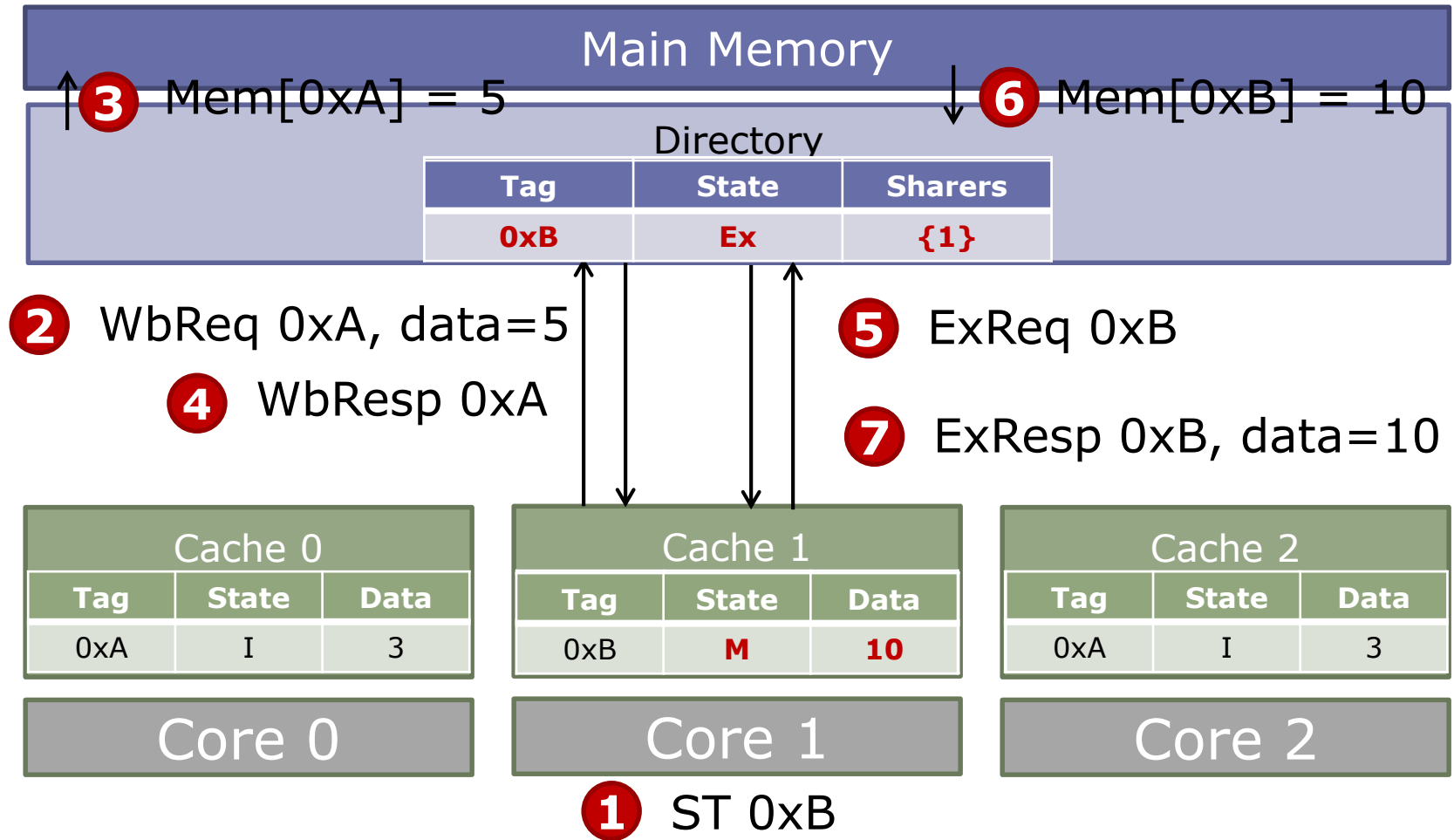

Why are 0xA's wb and 0xB's req serialized?

# MSI Directory Protocol Example

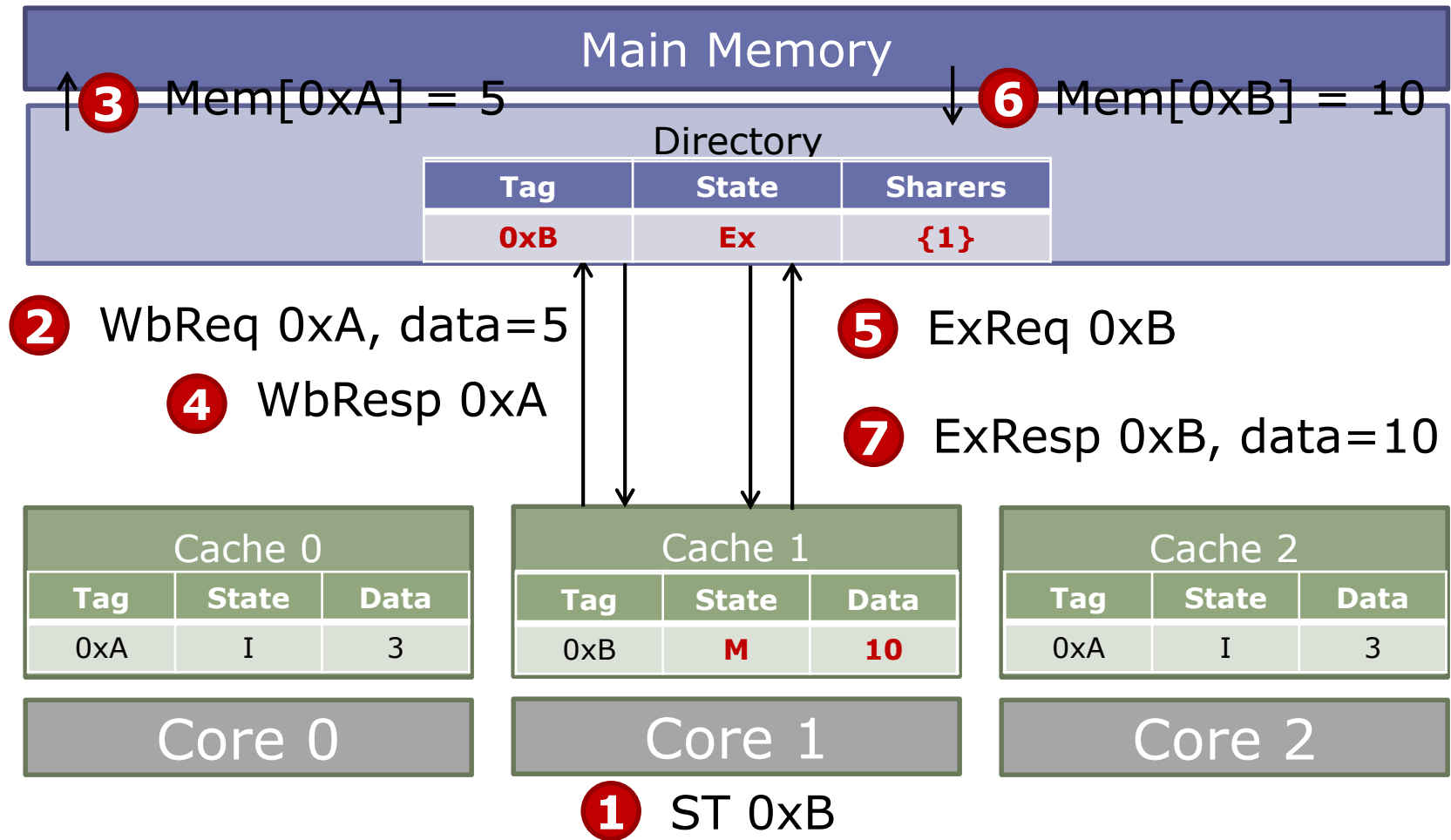

Why are 0xA's wb and 0xB's req serialized?

Structural dependence



# MSI Directory Protocol Example

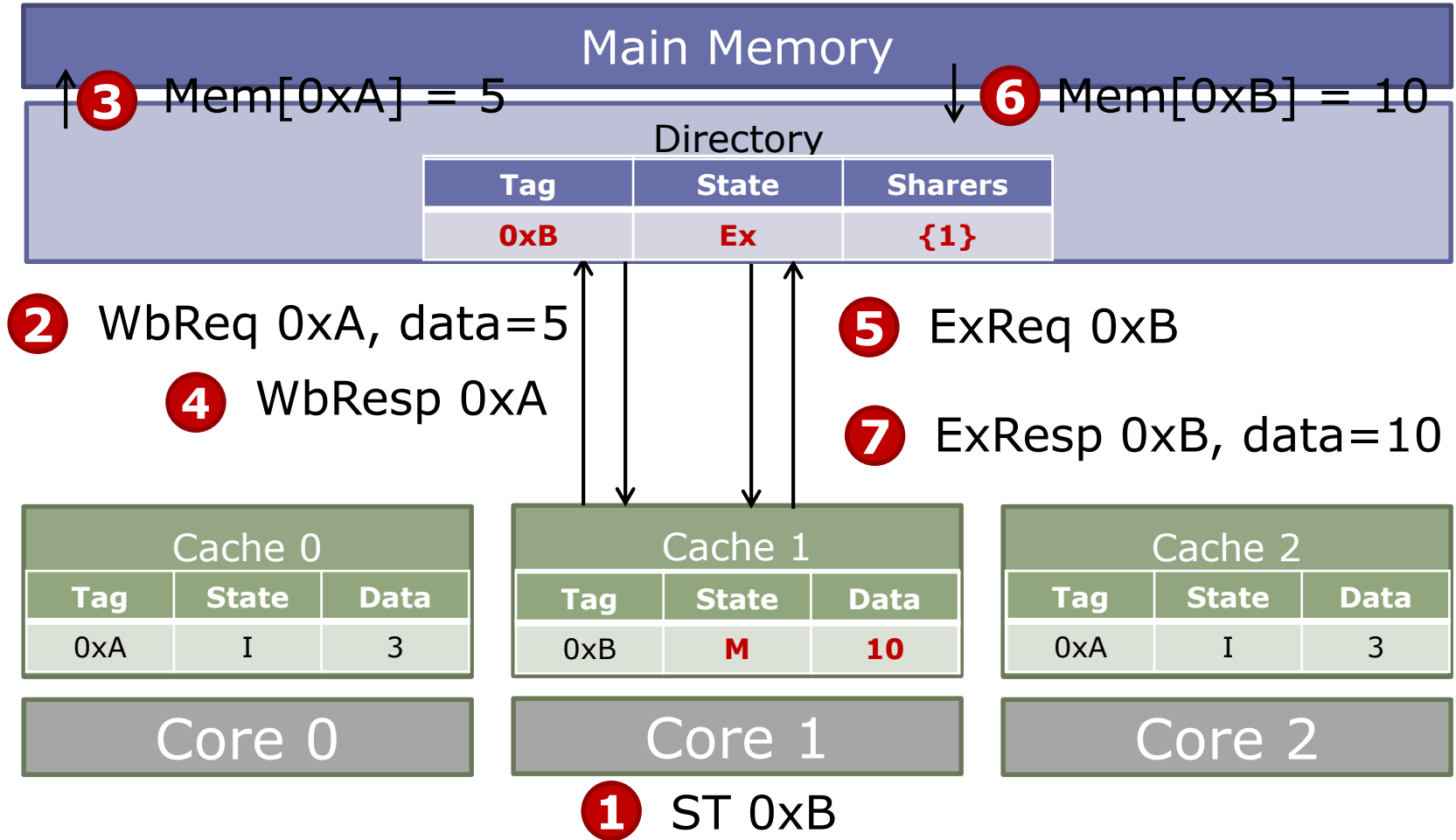

Why are 0xA's wb and 0xB's req serialized?  
Possible solutions?

Structural dependence

# MSI Directory Protocol Example

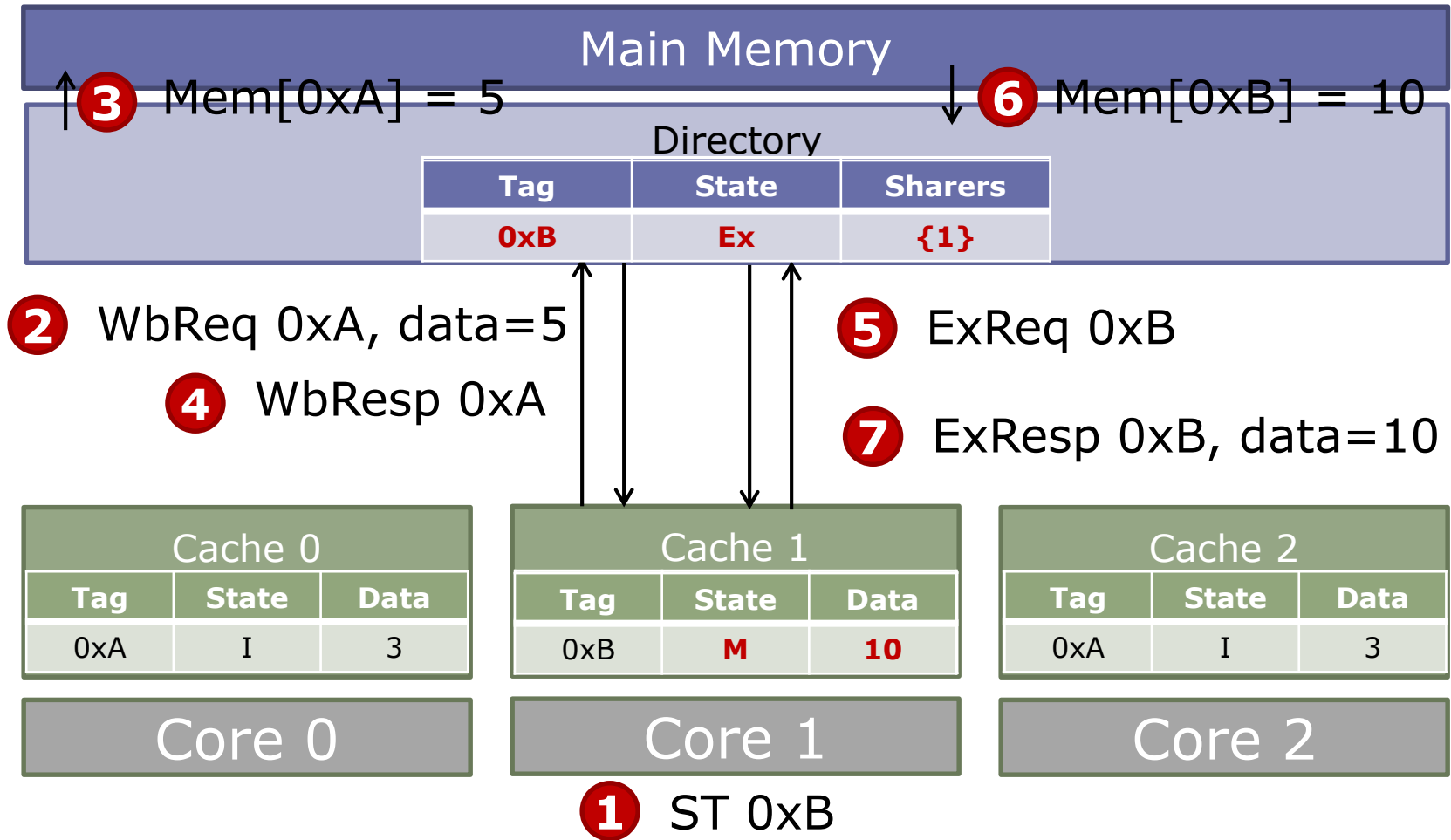

Why are 0xA's wb and 0xB's req serialized? **Structural dependence**

Possible solutions? **Buffer outside of cache to hold write data**

# Miss Status Handling Register

---

MSHR – Holds load misses and writes outside of cache

MSHR entry



- On eviction/writeback
  - No free MSHR entry: stall
  - Allocate new MSHR entry
  - When channel available send WBReq and data
  - Deallocate entry on WBResp

# Miss Status Handling Register

---

MSHR – Holds load misses and writes outside of cache

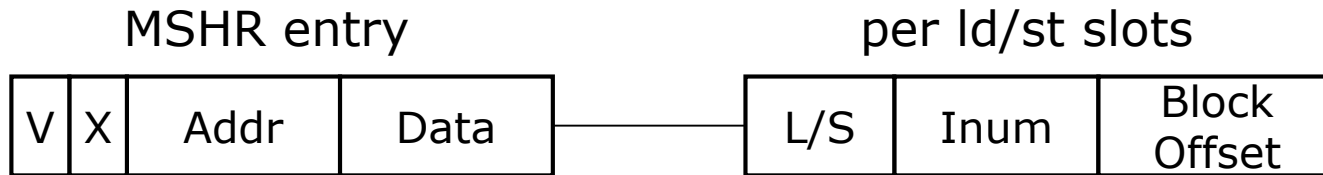

- On cache load miss
  - No free MSHR entry: stall
  - Allocate new MSHR entry
  - Send ShReq (or ExReq)
  - On \*Resp forward data to CPU and cache
  - Deallocate MSHR

# Miss Status Handling Register

---

MSHR – Holds load misses and writes outside of cache

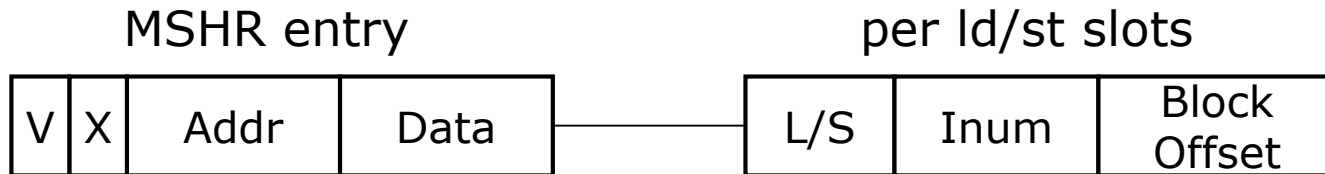

# Miss Status Handling Register

---

MSHR – Holds load misses and writes outside of cache

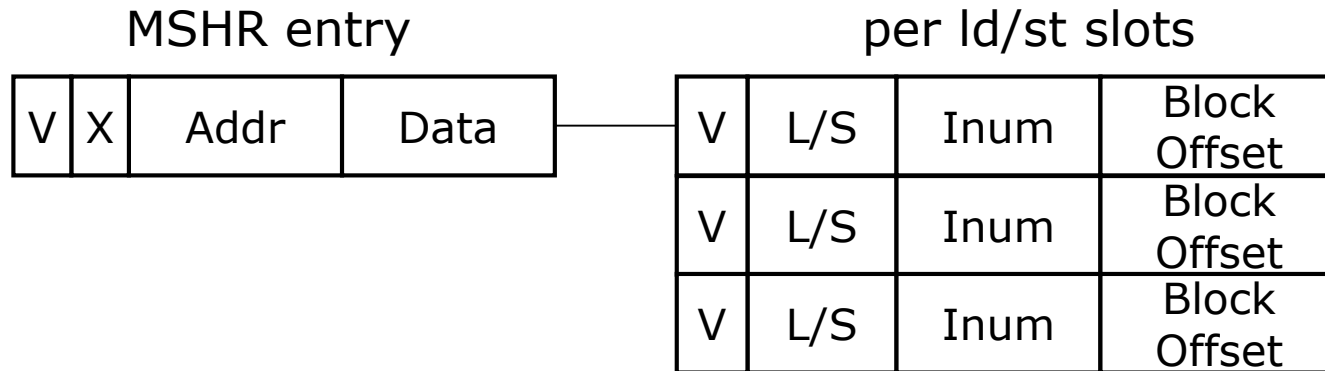

Per Id/st slots allow servicing multiple requests with one entry

# Miss Status Handling Register

MSHR – Holds load misses and writes outside of cache

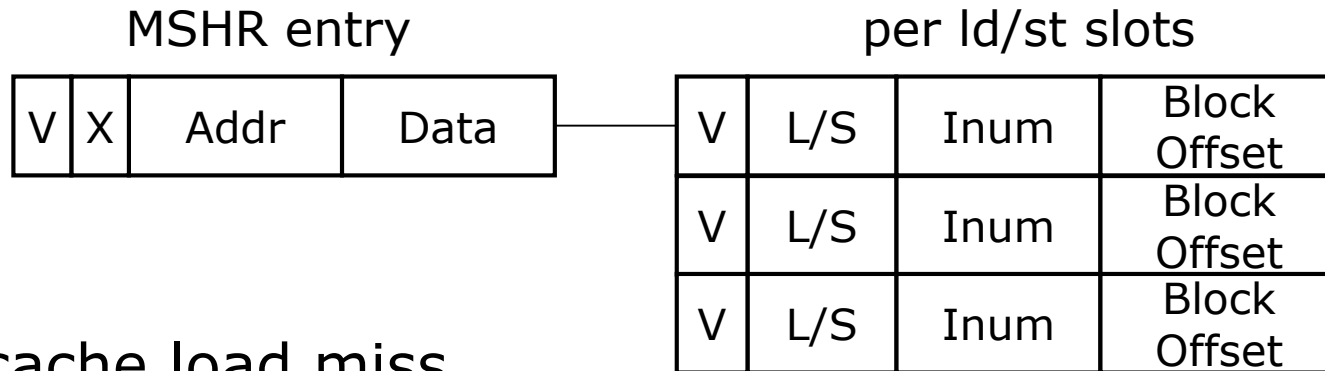

- On cache load miss
  - Look for matching address in MSHR
    - If not found
      - If no free MSHR entry: stall
      - Allocate new MSHR entry and fill in
    - If found, just fill in per Id/st slot
  - Send ShReq (or ExReq)
  - On \*Resp forward data to CPU and cache
  - Deallocate MSHR

Per Id/st slots allow servicing multiple requests with one entry

# Directory Organization

---

- Requirement: Directory needs to keep track of all the cores that are sharing a cache block
- Challenge: For each block, the space needed to hold the list of sharers grows with number of possible sharers...



# Flat, Memory-based Directories

---

- Dedicate a few bits of main memory to store the state and sharers of every line
- Encode sharers using a bit-vector

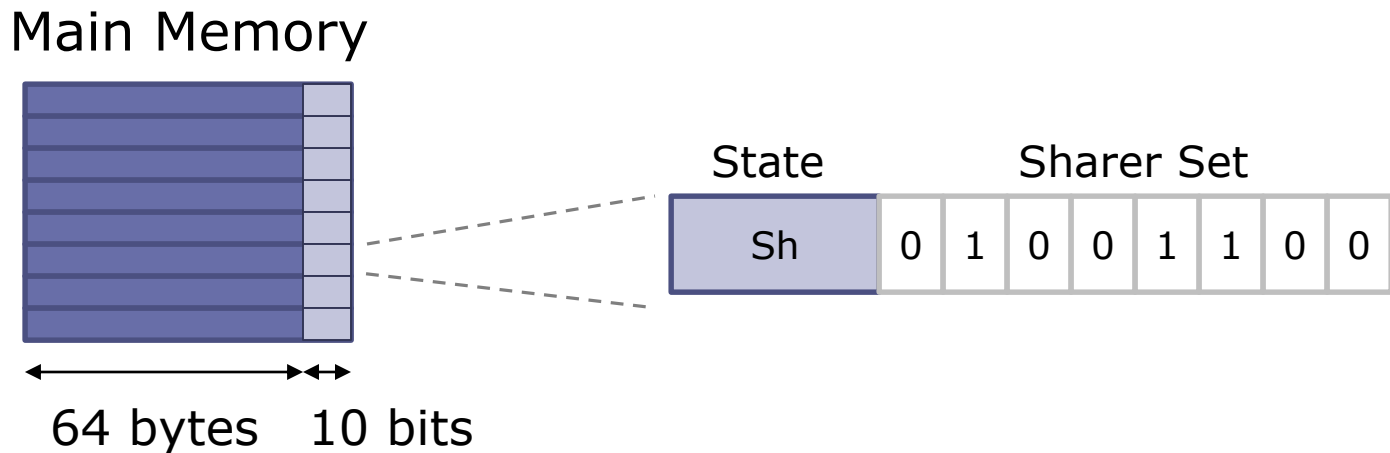

# Flat, Memory-based Directories

- Dedicate a few bits of main memory to store the state and sharers of every line
- Encode sharers using a bit-vector

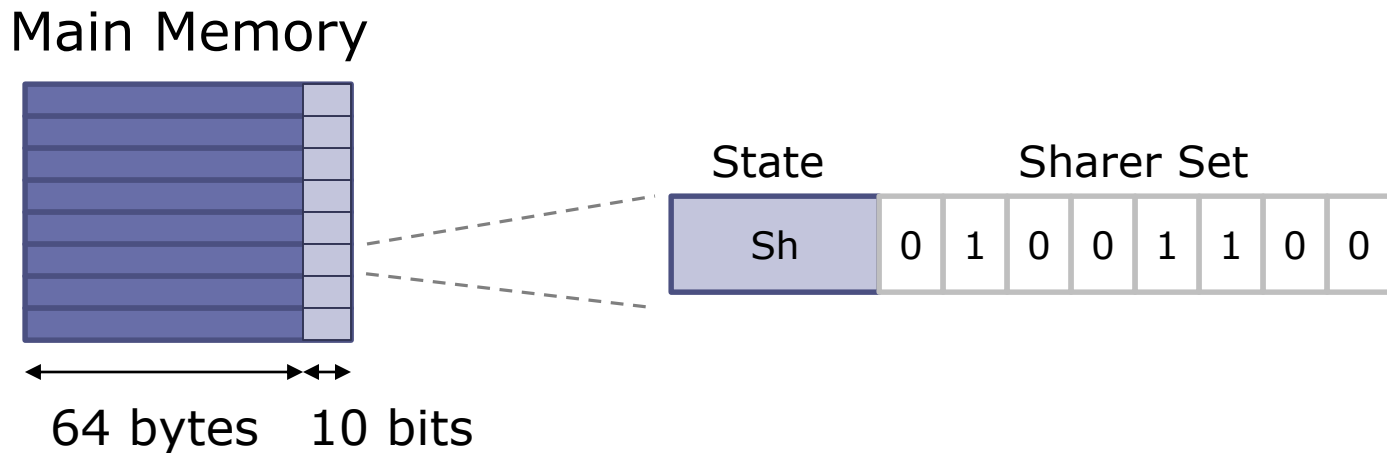

✓ Simple

✗ Slow

✗ Very inefficient with many processors ( $\sim P$  bits/line)

# Sparse Full-Map Directories

- Not every line in the system needs to be tracked – only those in private caches!
- Idea: Organize directory as a cache

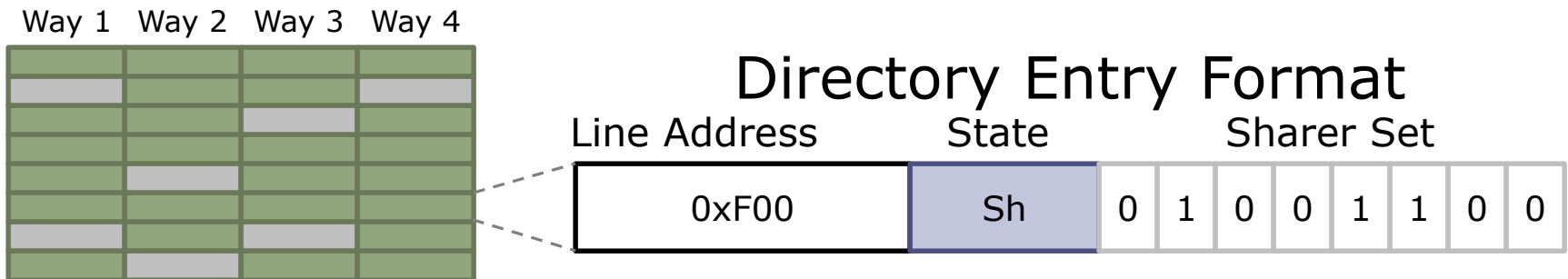

# Sparse Full-Map Directories

- Not every line in the system needs to be tracked – only those in private caches!
- Idea: Organize directory as a cache

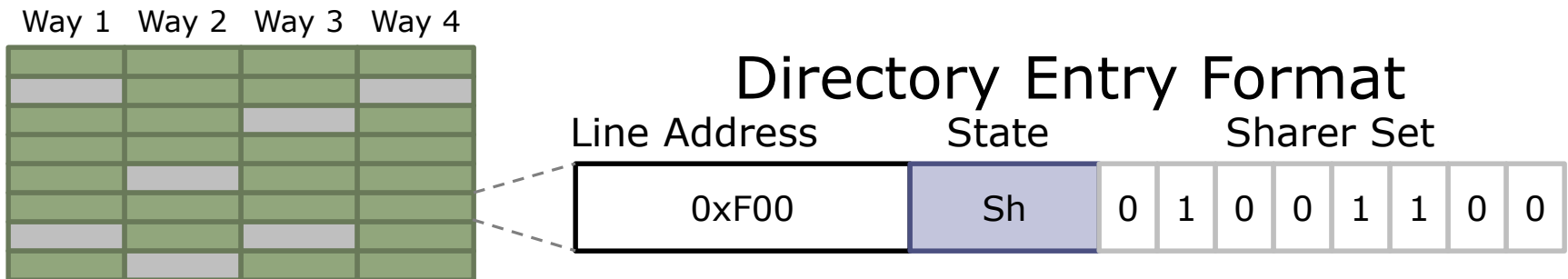

- ✓ Low latency, energy-efficient
- ✗ Bit-vectors grow with # cores → Area scales poorly
- ✗ Limited associativity → Directory-induced invalidations

# Directory-Induced Invalidations

- To retain inclusion, must invalidate all sharers of an entry before reusing it for another address
- Example: 2-way set-associative sparse directory

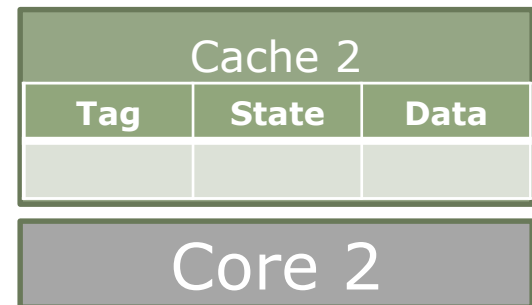
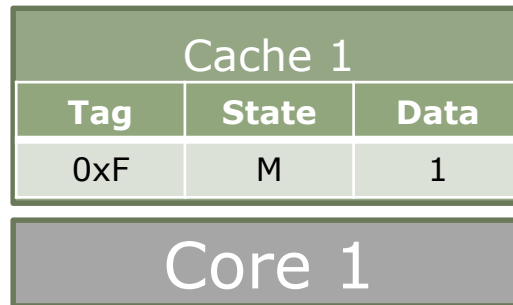
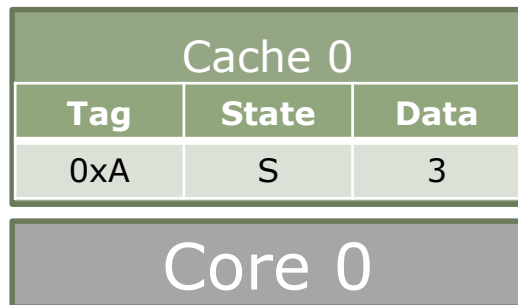
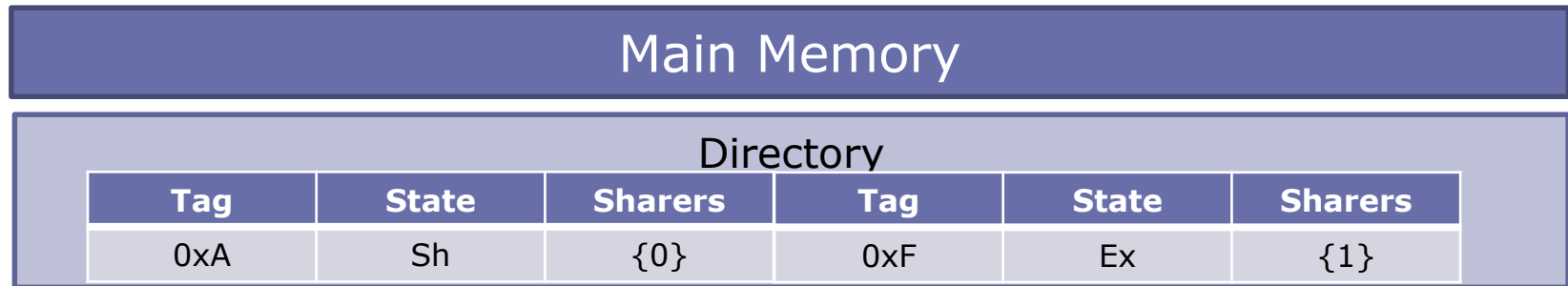

# Directory-Induced Invalidations

- To retain inclusion, must invalidate all sharers of an entry before reusing it for another address
- Example: 2-way set-associative sparse directory

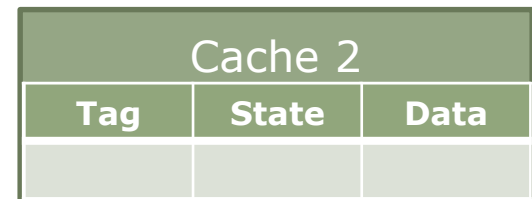
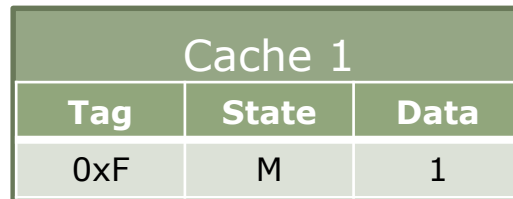
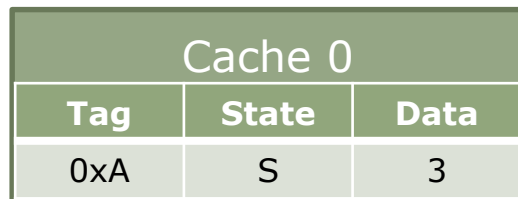
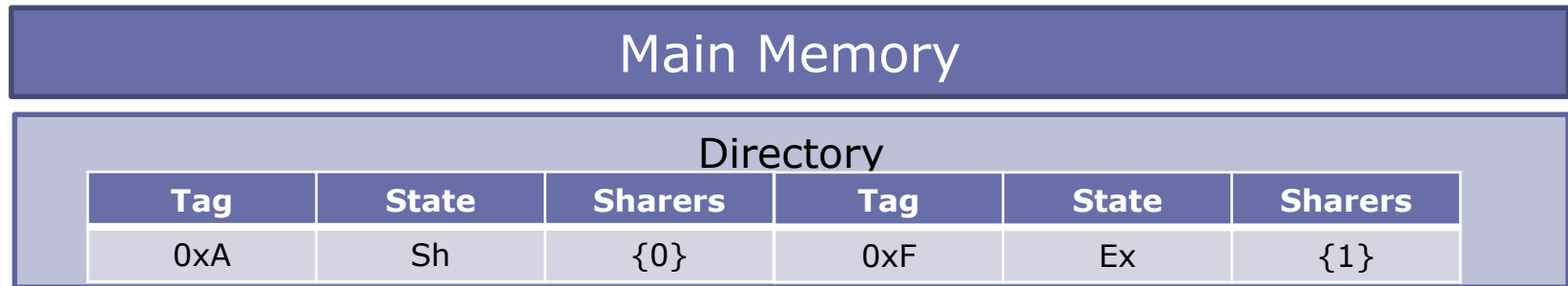

**1** LD 0xB

# Directory-Induced Invalidations

- To retain inclusion, must invalidate all sharers of an entry before reusing it for another address
- Example: 2-way set-associative sparse directory

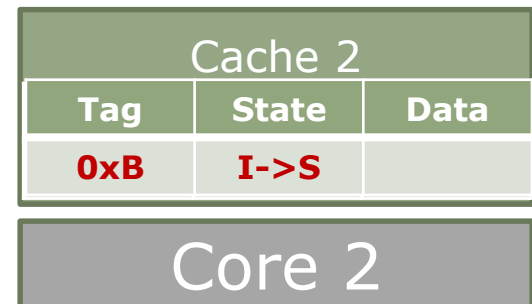
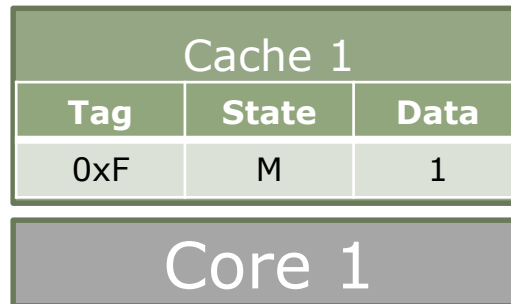
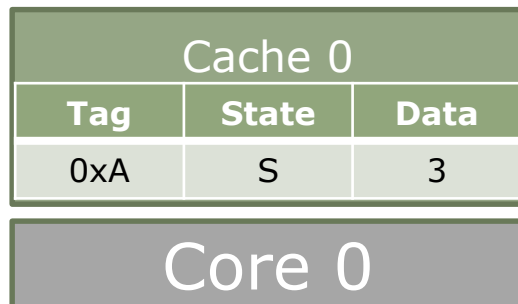
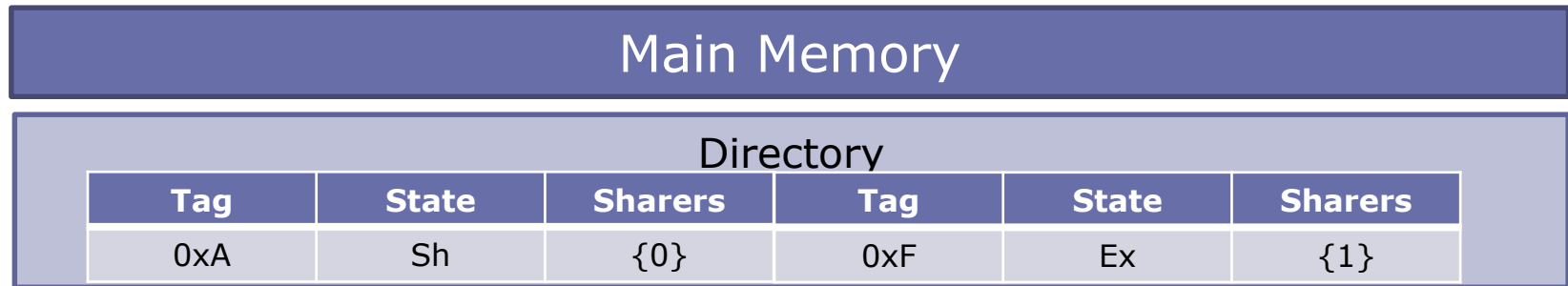

**1** LD 0xB

# Directory-Induced Invalidations

- To retain inclusion, must invalidate all sharers of an entry before reusing it for another address
- Example: 2-way set-associative sparse directory

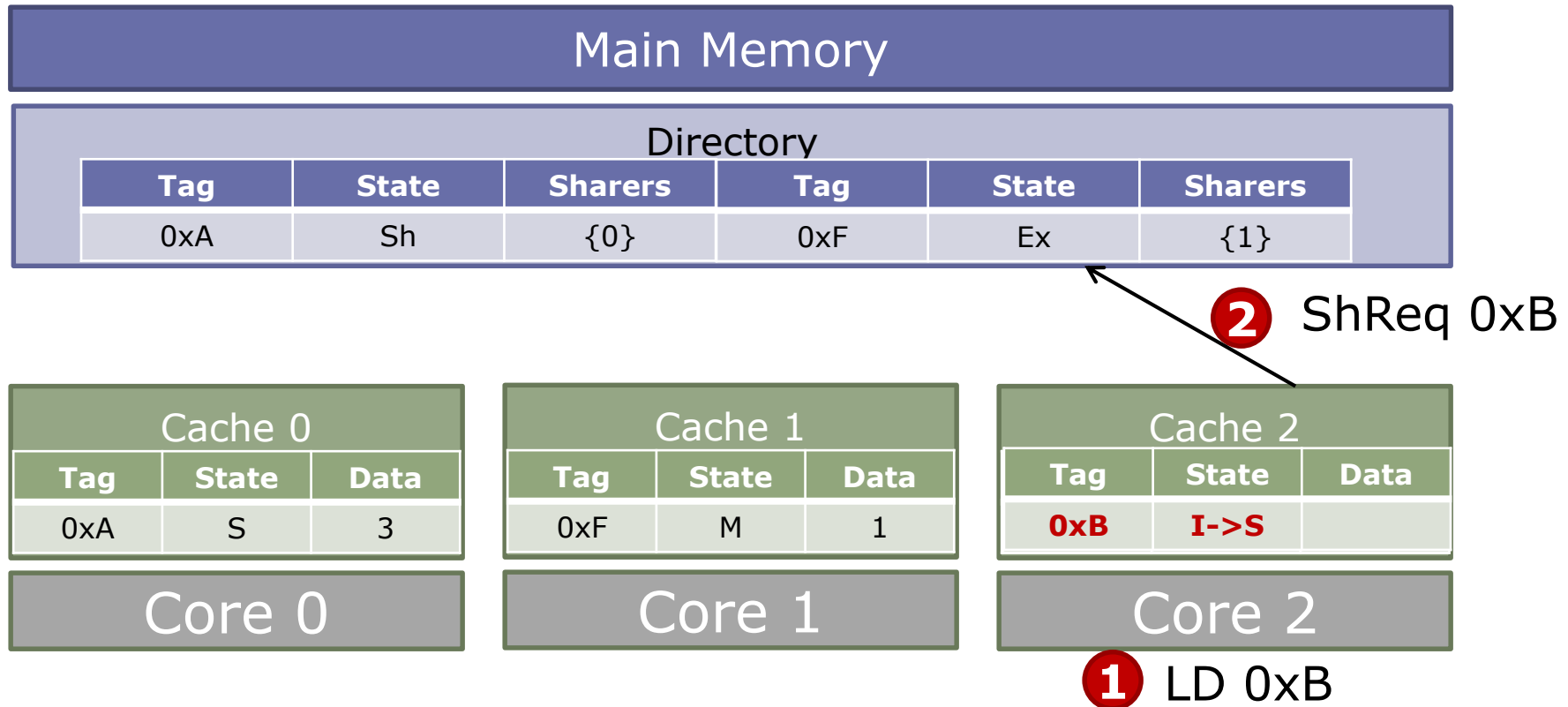



# Directory-Induced Invalidations

- To retain inclusion, must invalidate all sharers of an entry before reusing it for another address
- Example: 2-way set-associative sparse directory

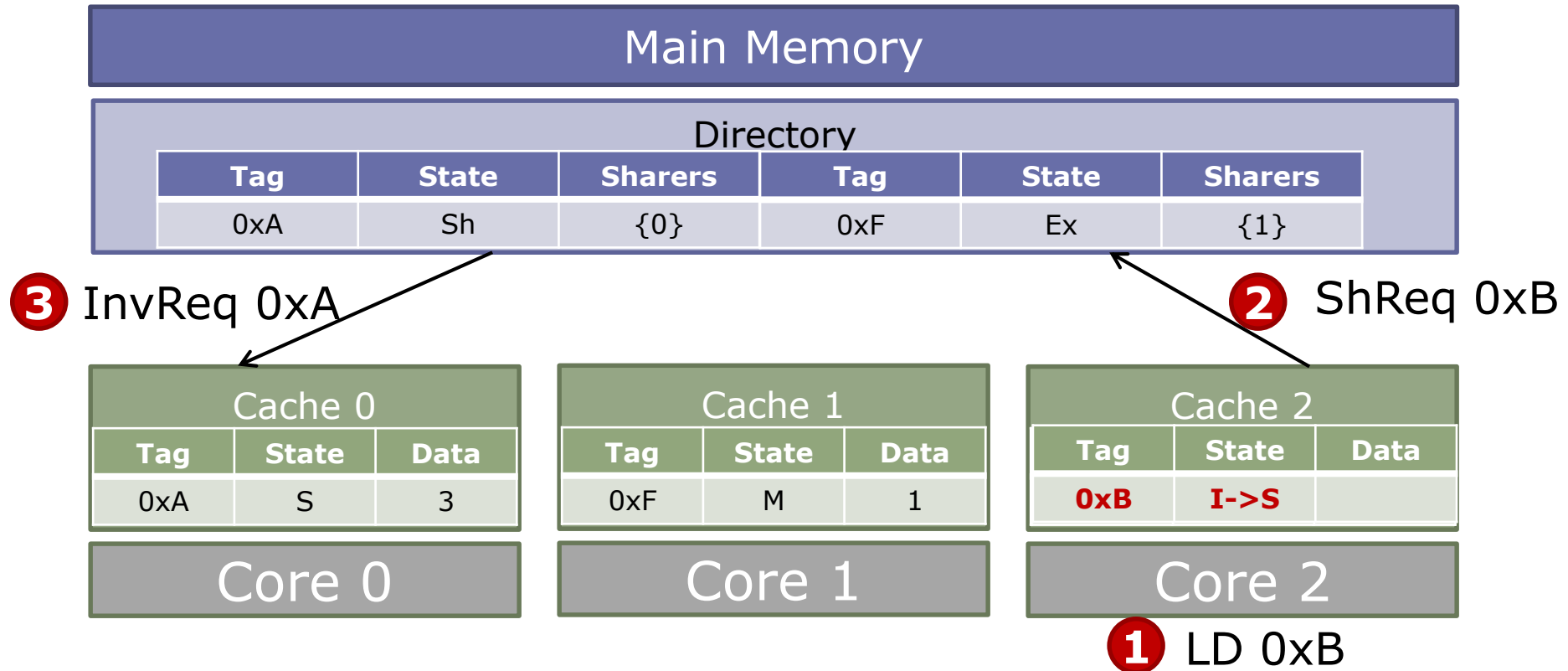

# Directory-Induced Invalidations

- To retain inclusion, must invalidate all sharers of an entry before reusing it for another address
- Example: 2-way set-associative sparse directory

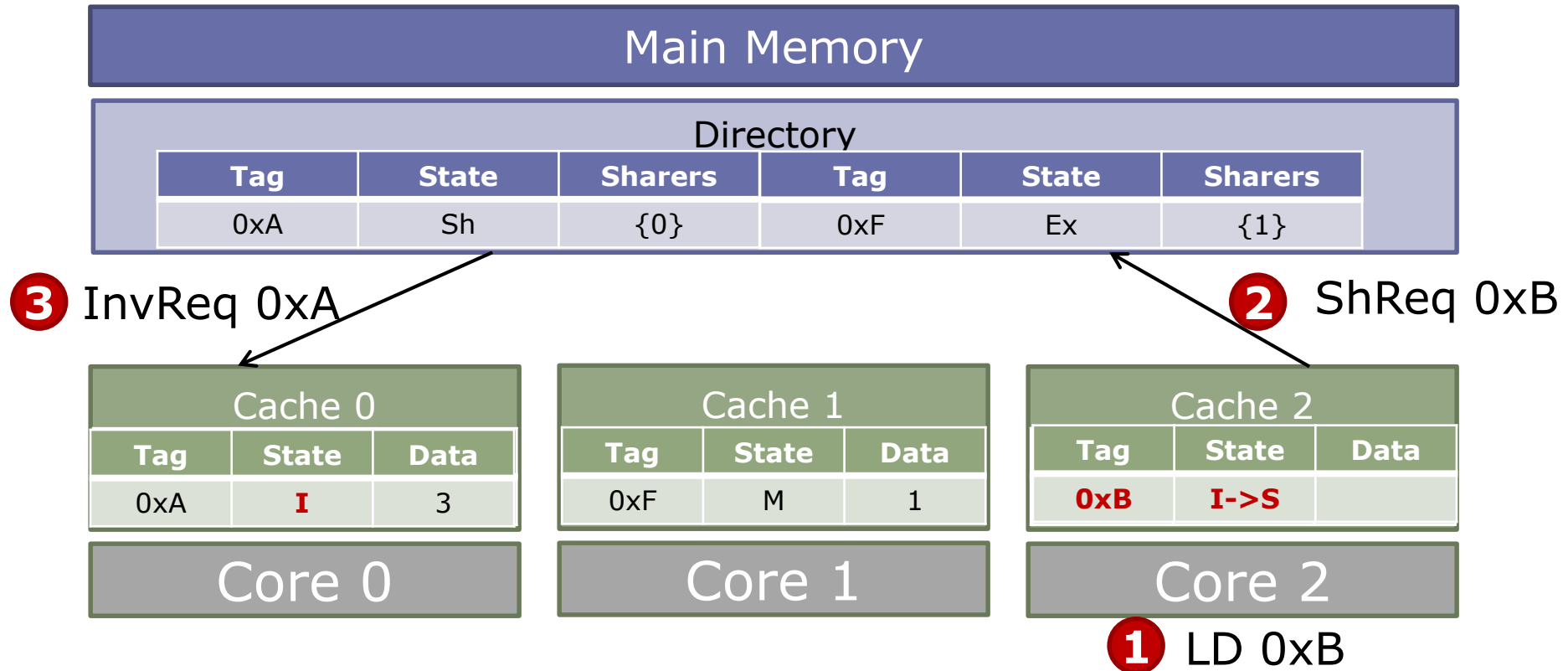

# Directory-Induced Invalidations

- To retain inclusion, must invalidate all sharers of an entry before reusing it for another address
- Example: 2-way set-associative sparse directory

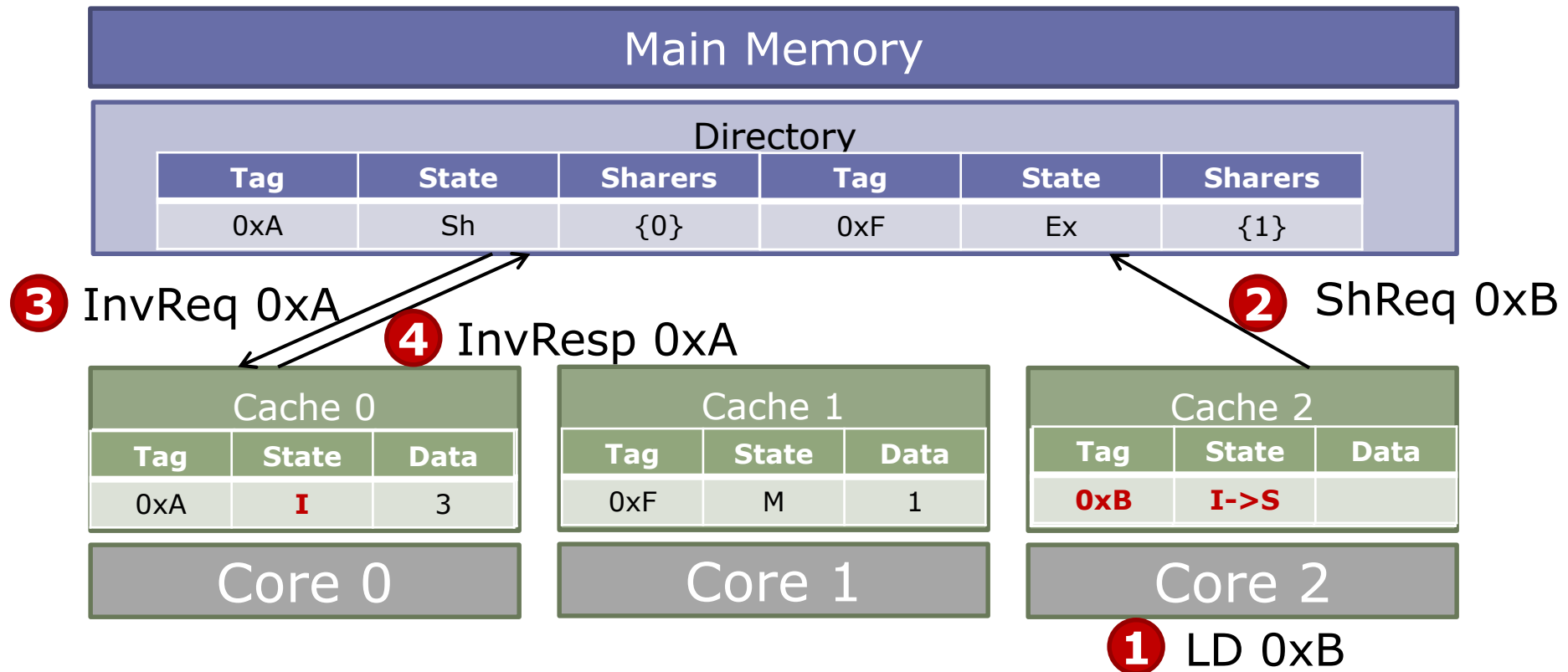

# Directory-Induced Invalidations

- To retain inclusion, must invalidate all sharers of an entry before reusing it for another address
- Example: 2-way set-associative sparse directory

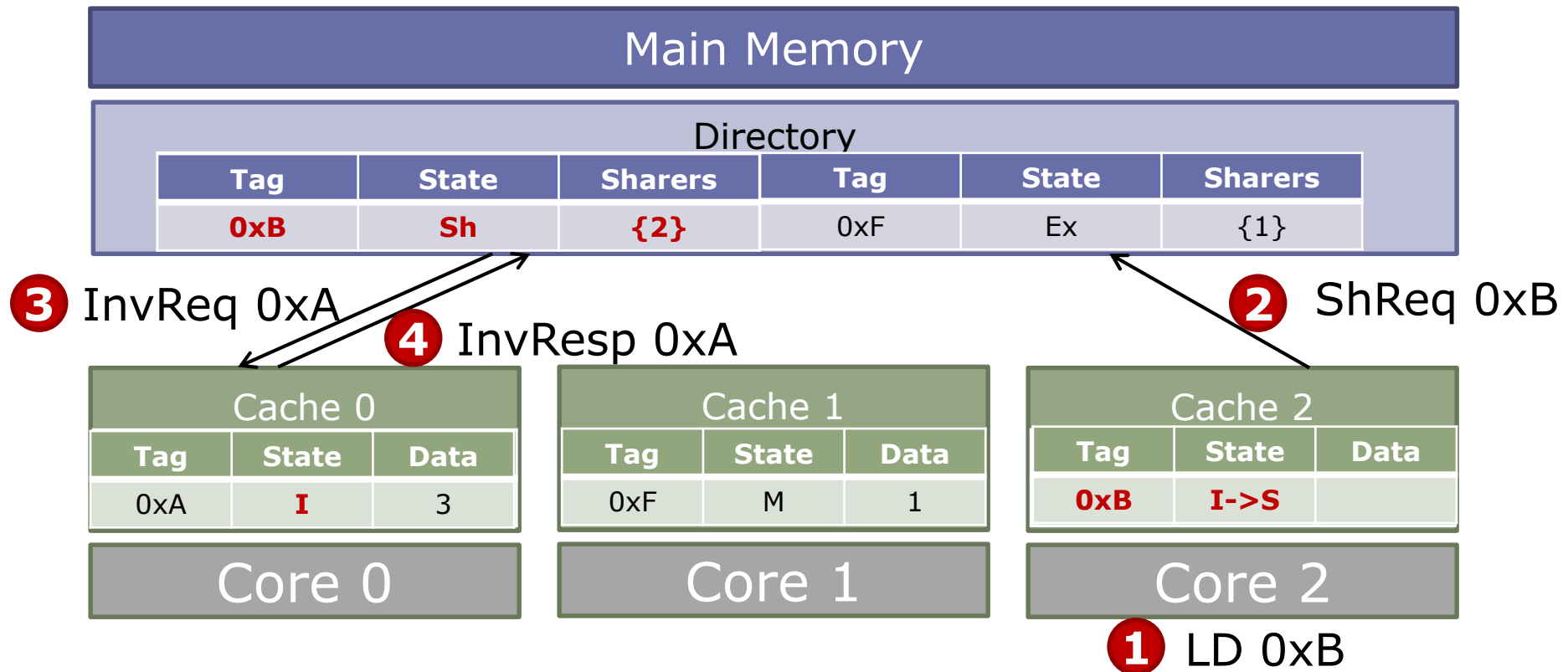

# Directory-Induced Invalidations

- To retain inclusion, must invalidate all sharers of an entry before reusing it for another address
- Example: 2-way set-associative sparse directory

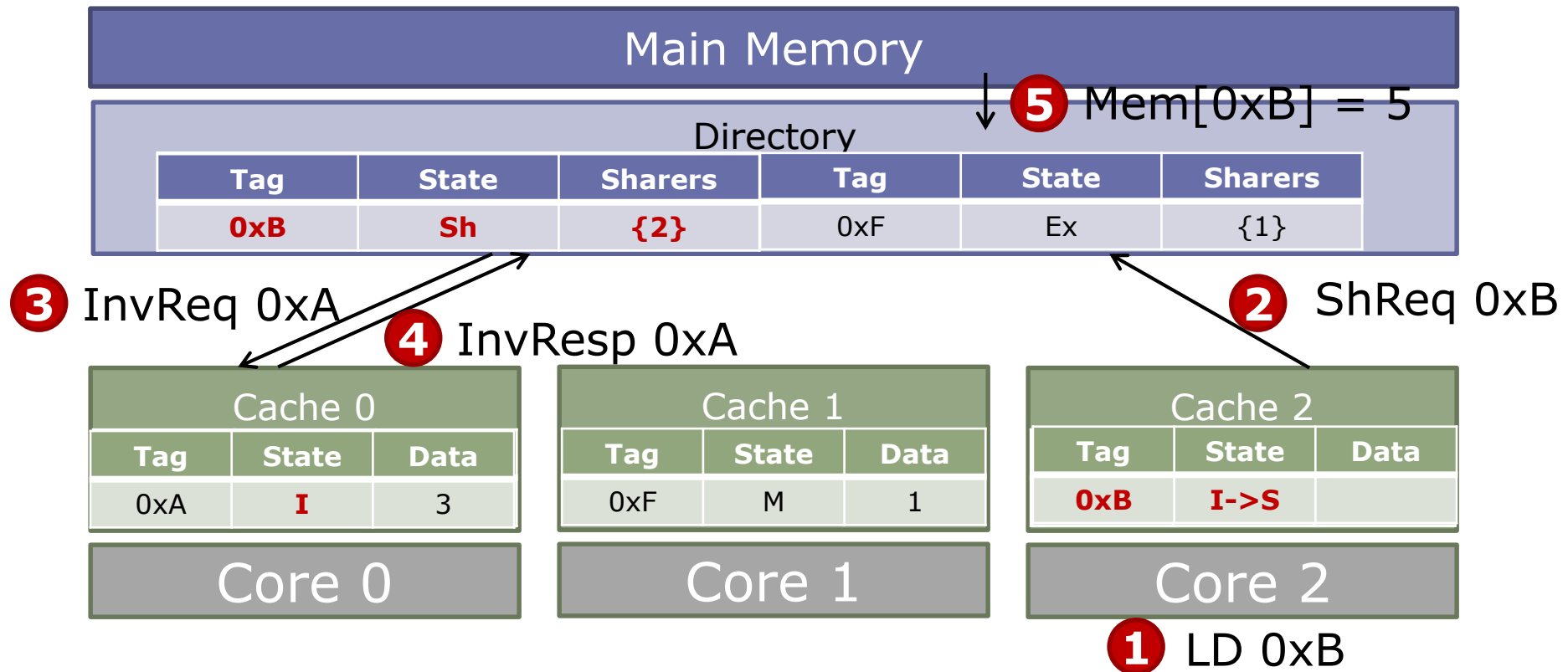

# Directory-Induced Invalidations

- To retain inclusion, must invalidate all sharers of an entry before reusing it for another address
- Example: 2-way set-associative sparse directory

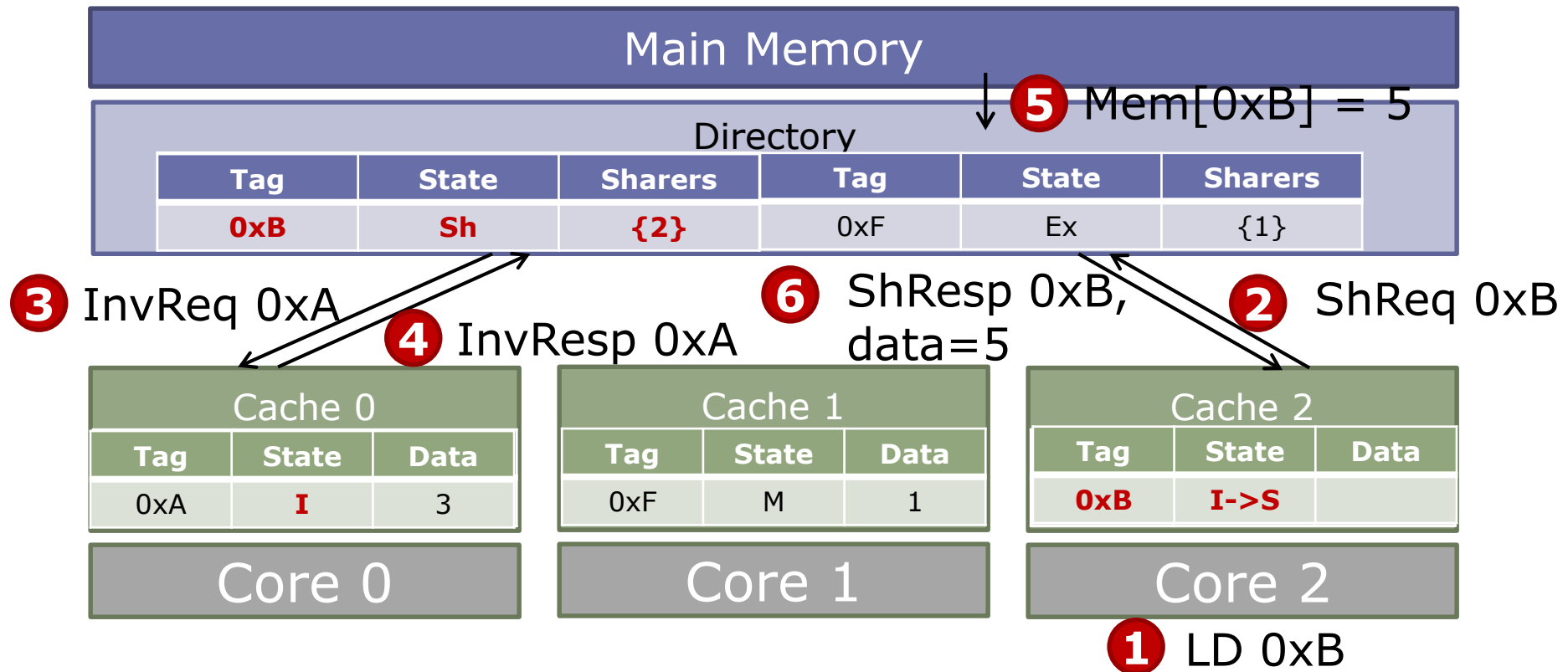

# Directory-Induced Invalidations

- To retain inclusion, must invalidate all sharers of an entry before reusing it for another address
- Example: 2-way set-associative sparse directory

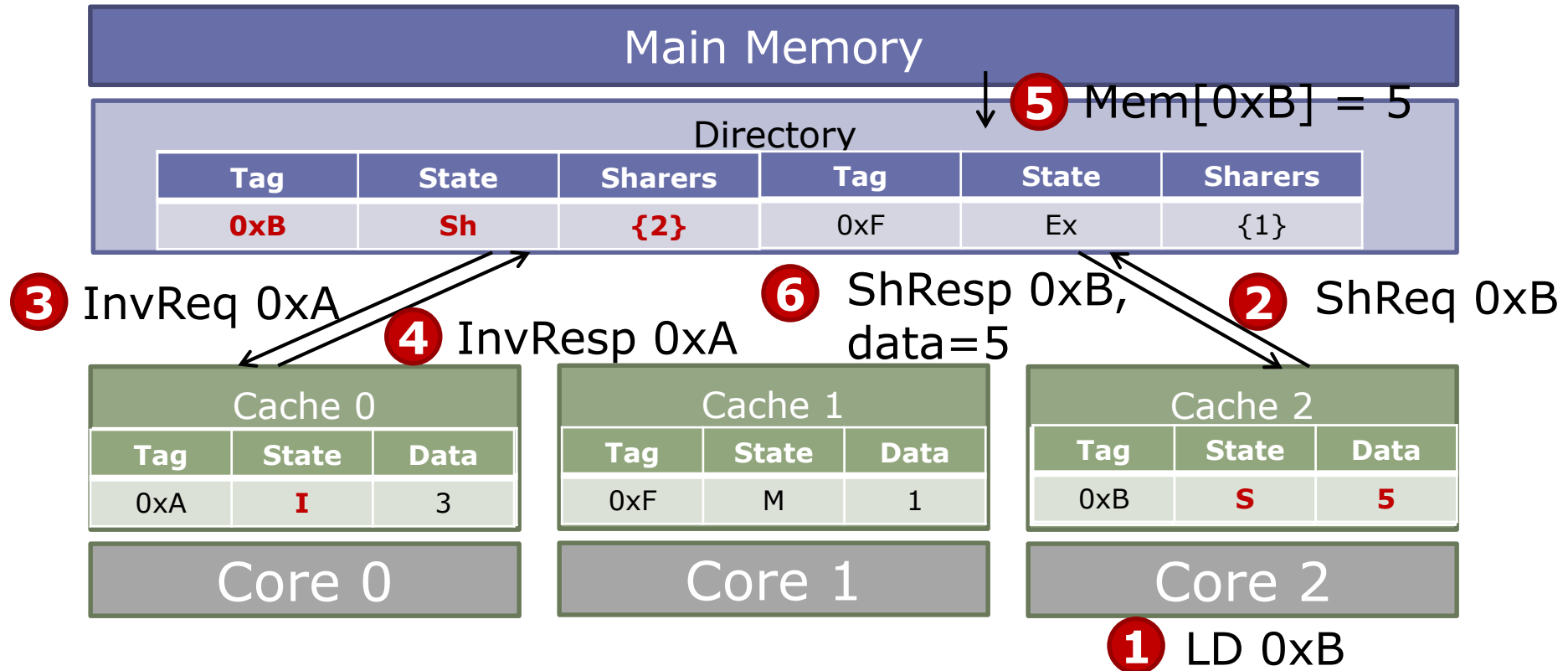

# Directory-Induced Invalidations

- To retain inclusion, must invalidate all sharers of an entry before reusing it for another address
- Example: 2-way set-associative sparse directory

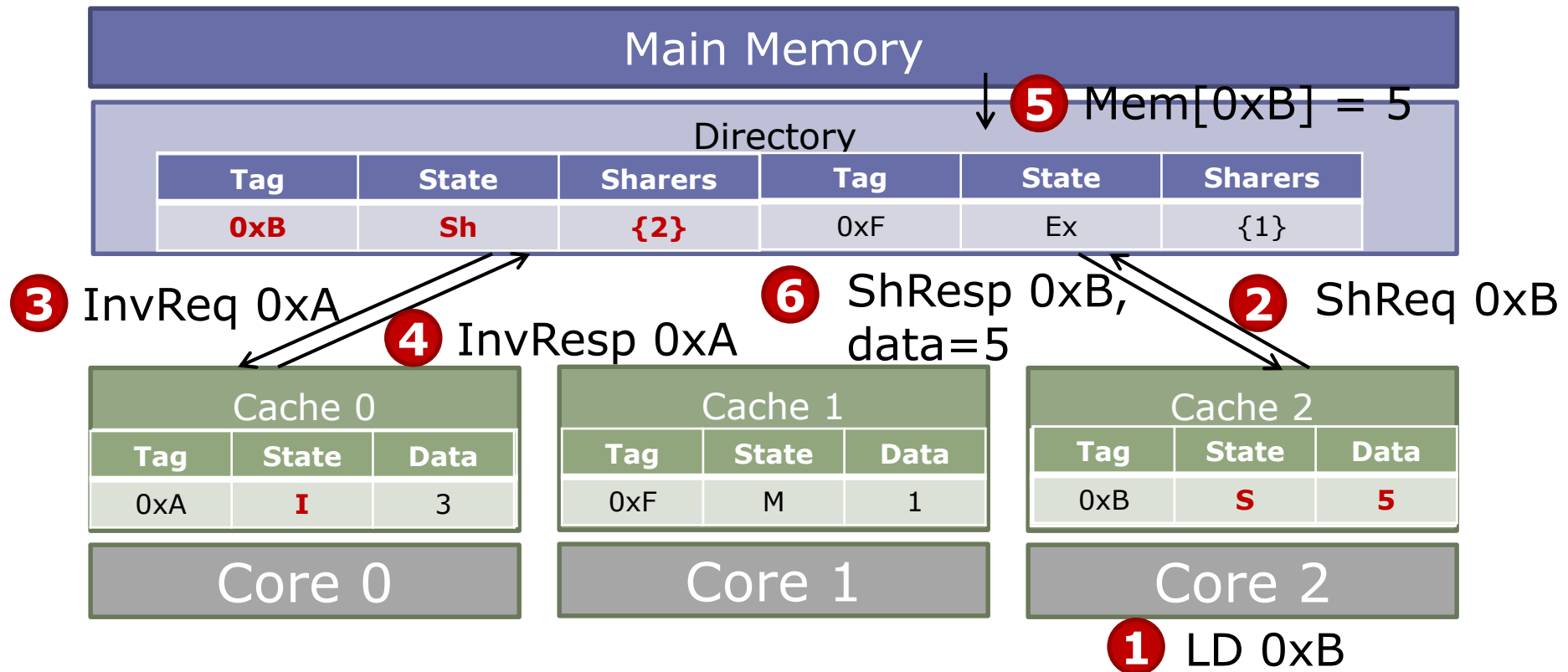

*How many entries should the directory have?*



# Inexact Representations of Sharer Sets

---

- Coarse-grain bit-vectors (e.g., 1 bit per 4 cores)

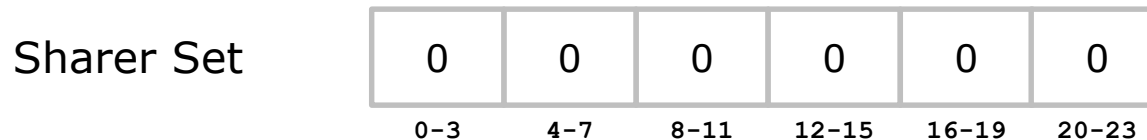

- Limited pointers: Maintain a few sharer pointers, on overflow mark 'all' and broadcast (or invalidate another sharer)

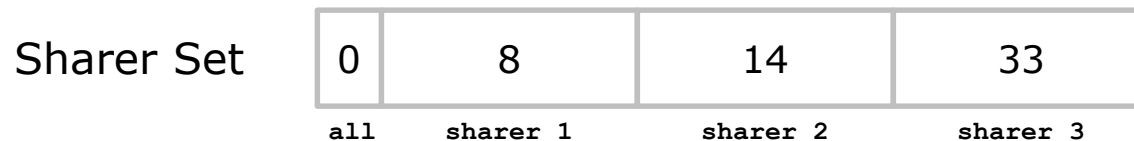

- Allow false positives (e.g., Bloom filters)

# Inexact Representations of Sharer Sets

---

- Coarse-grain bit-vectors (e.g., 1 bit per 4 cores)

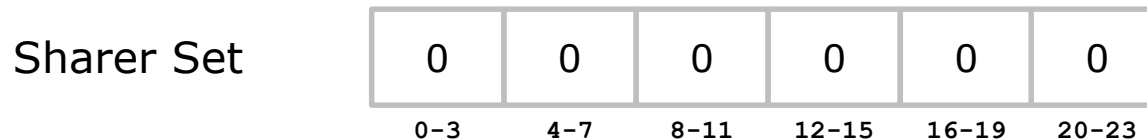

- Limited pointers: Maintain a few sharer pointers, on overflow mark 'all' and broadcast (or invalidate another sharer)

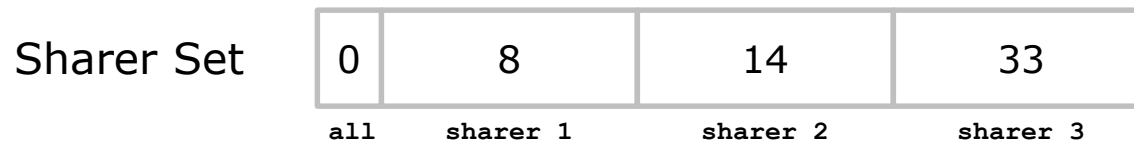

- Allow false positives (e.g., Bloom filters)
  - ✓ Reduced area & energy
  - ✗ Overheads still not scalable (these techniques simply play with constant factors)
  - ✗ Inexact sharers → Broadcasts, invalidations or spurious invalidations and downgrades

# Protocol Races

- Directory serializes multiple requests for the same address
  - Same-address requests are queued or NACKed and retried
- But races still exist due to conflicting requests
- Example: Upgrade race

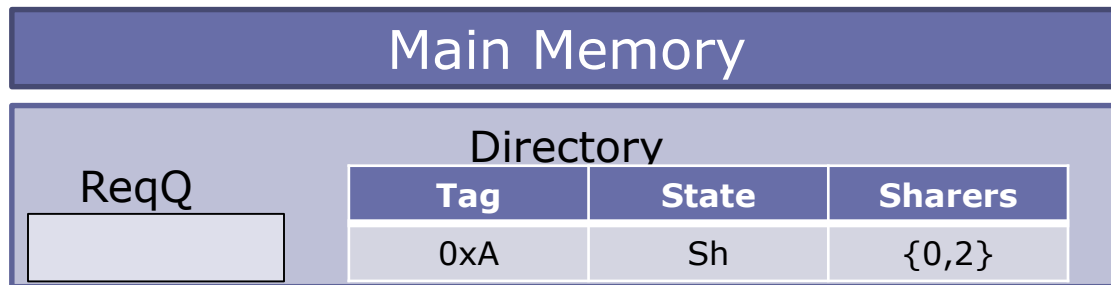

Cache 0		
Tag	State	Data
0xA	S	3

Core 0

Cache 1		
Tag	State	Data
0xA	S	3

Core 1

# Protocol Races

- Directory serializes multiple requests for the same address
  - Same-address requests are queued or NACKed and retried
- But races still exist due to conflicting requests
- Example: Upgrade race

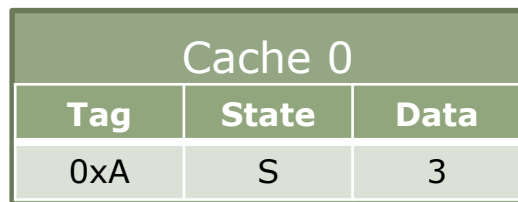
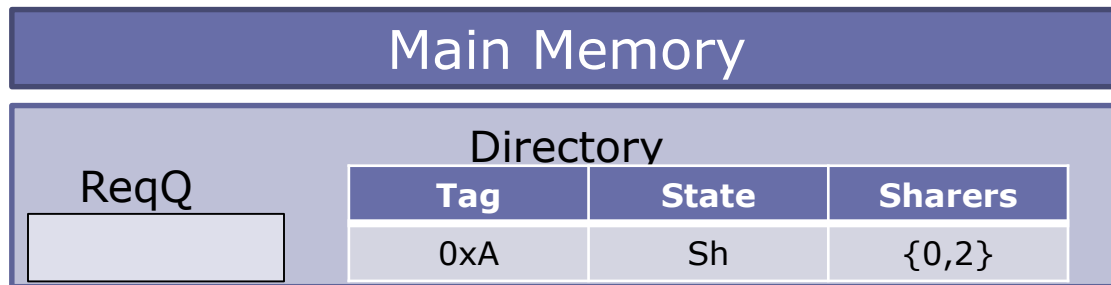

**1** ST 0xA

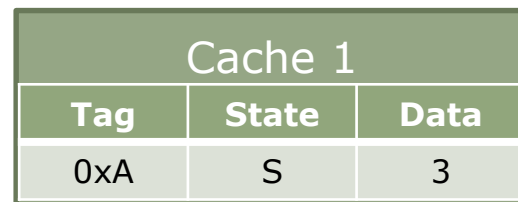

**1'** ST 0xA

# Protocol Races

- Directory serializes multiple requests for the same address
  - Same-address requests are queued or NACKed and retried
- But races still exist due to conflicting requests
- Example: Upgrade race

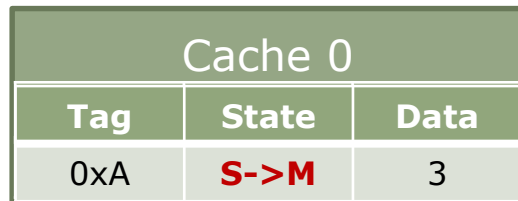
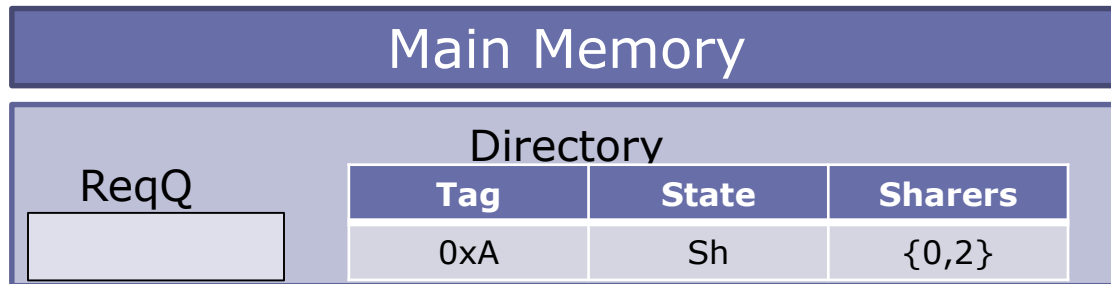

**1** ST 0xA

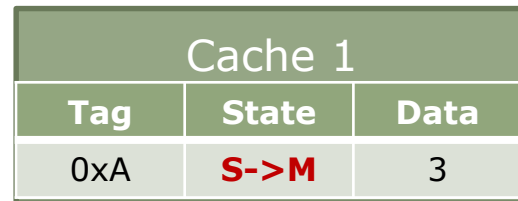

**1'** ST 0xA

# Protocol Races

- Directory serializes multiple requests for the same address
  - Same-address requests are queued or NACKed and retried
- But races still exist due to conflicting requests
- Example: Upgrade race

Caches 0 and 1 issue simultaneous ExReqs

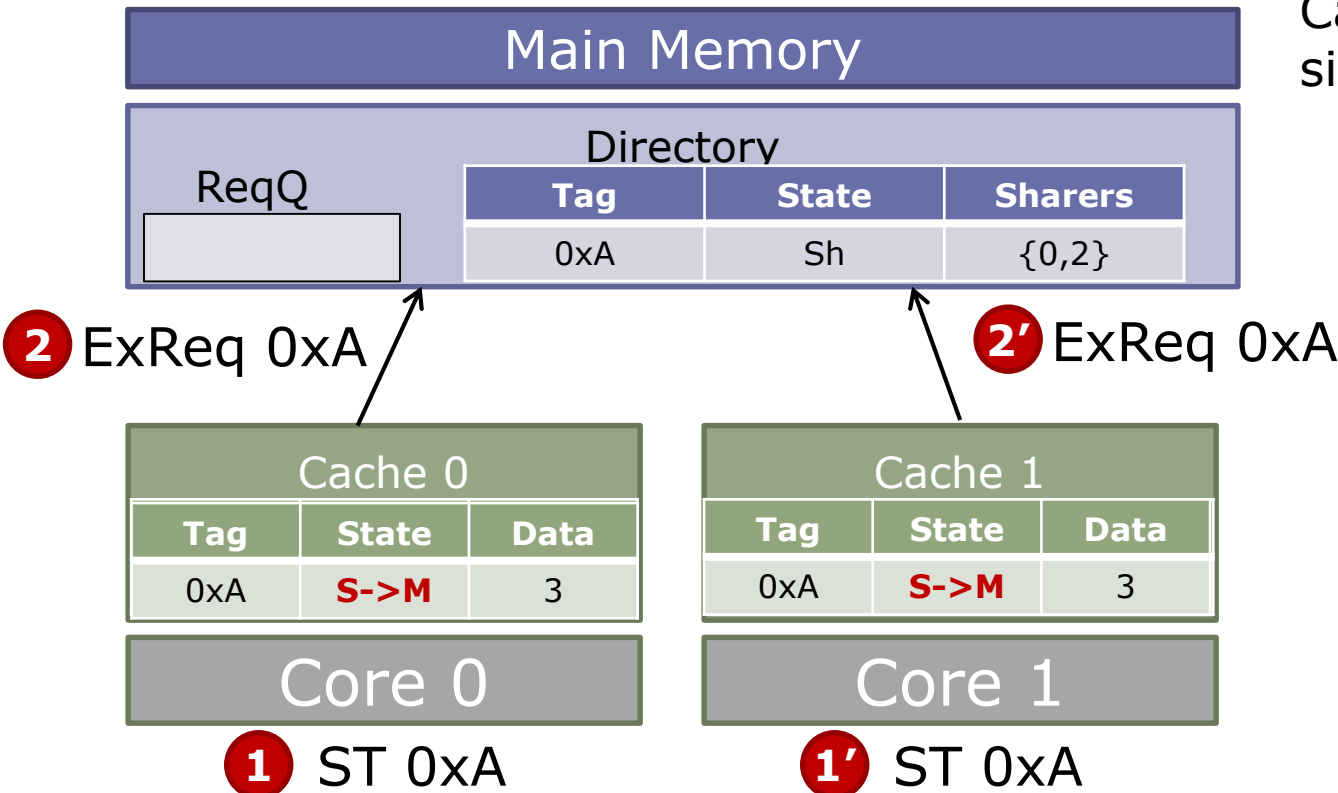

# Protocol Races

- Directory serializes multiple requests for the same address
  - Same-address requests are queued or NACKed and retried
- But races still exist due to conflicting requests
- Example: Upgrade race

Caches 0 and 1 issue simultaneous ExReqs  
 Directory starts serving cache 0's ExReq,  
 queues cache 1's

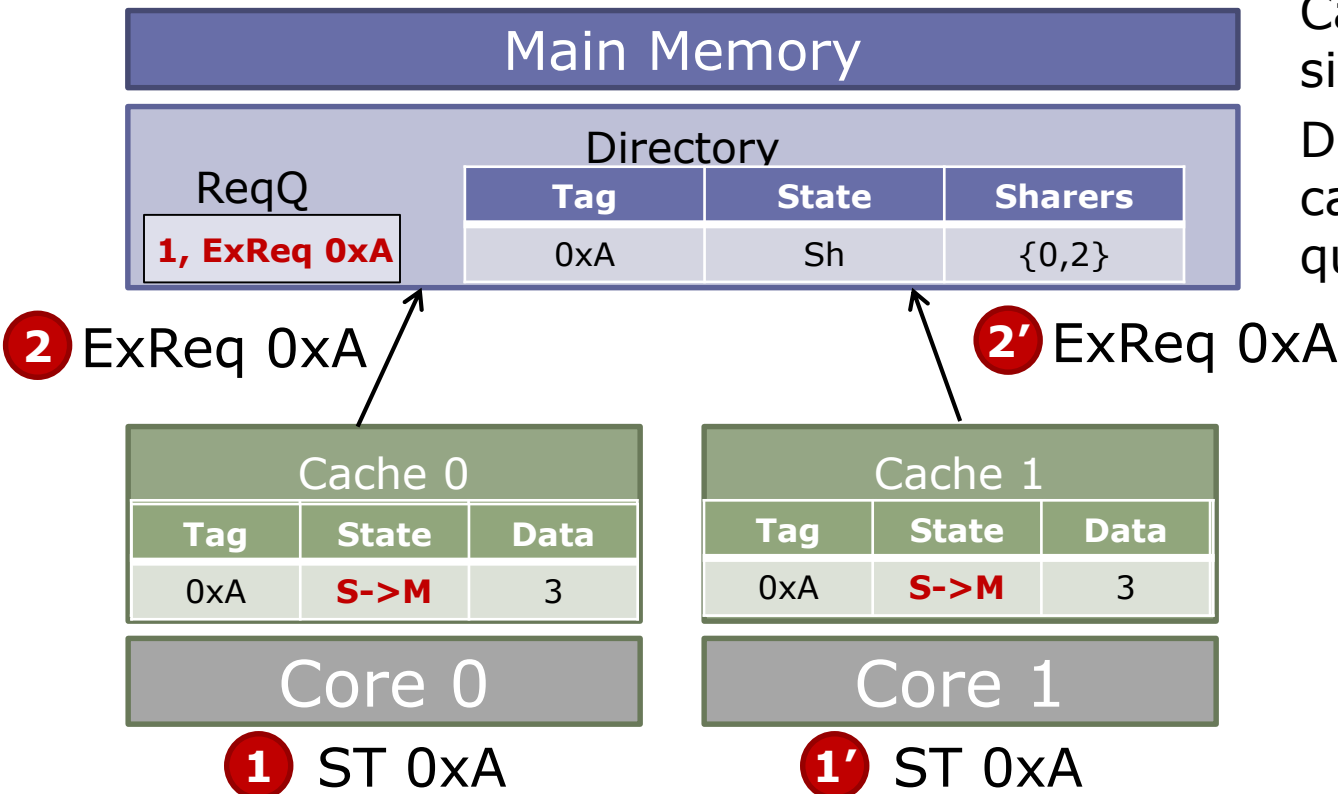

# Protocol Races

- Directory serializes multiple requests for the same address
  - Same-address requests are queued or NACKed and retried
- But races still exist due to conflicting requests
- Example: Upgrade race

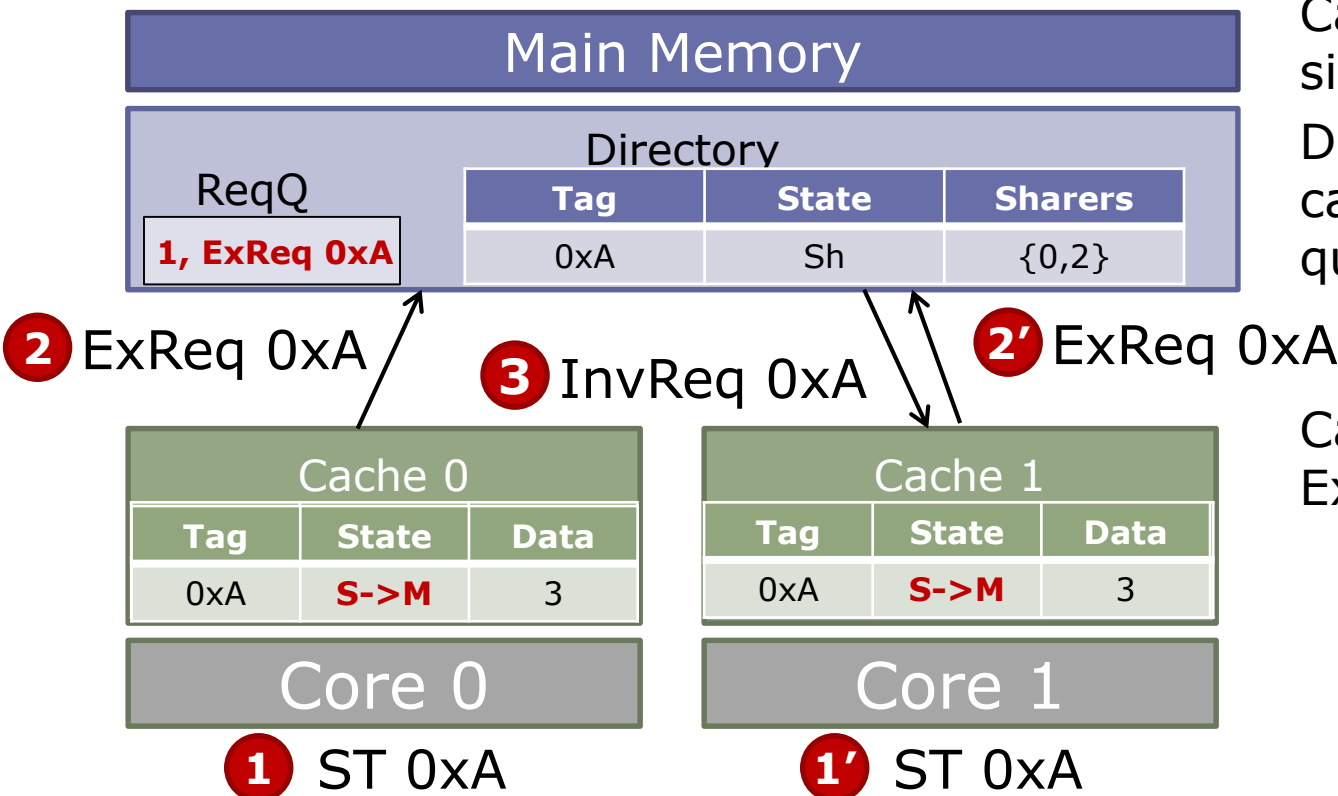

Caches 0 and 1 issue simultaneous ExReqs  
 Directory starts serving cache 0's ExReq, queues cache 1's

Cache 1 expected ExResp, but got InvReq!



# Protocol Races

- Directory serializes multiple requests for the same address
  - Same-address requests are queued or NACKed and retried
- But races still exist due to conflicting requests
- Example: Upgrade race

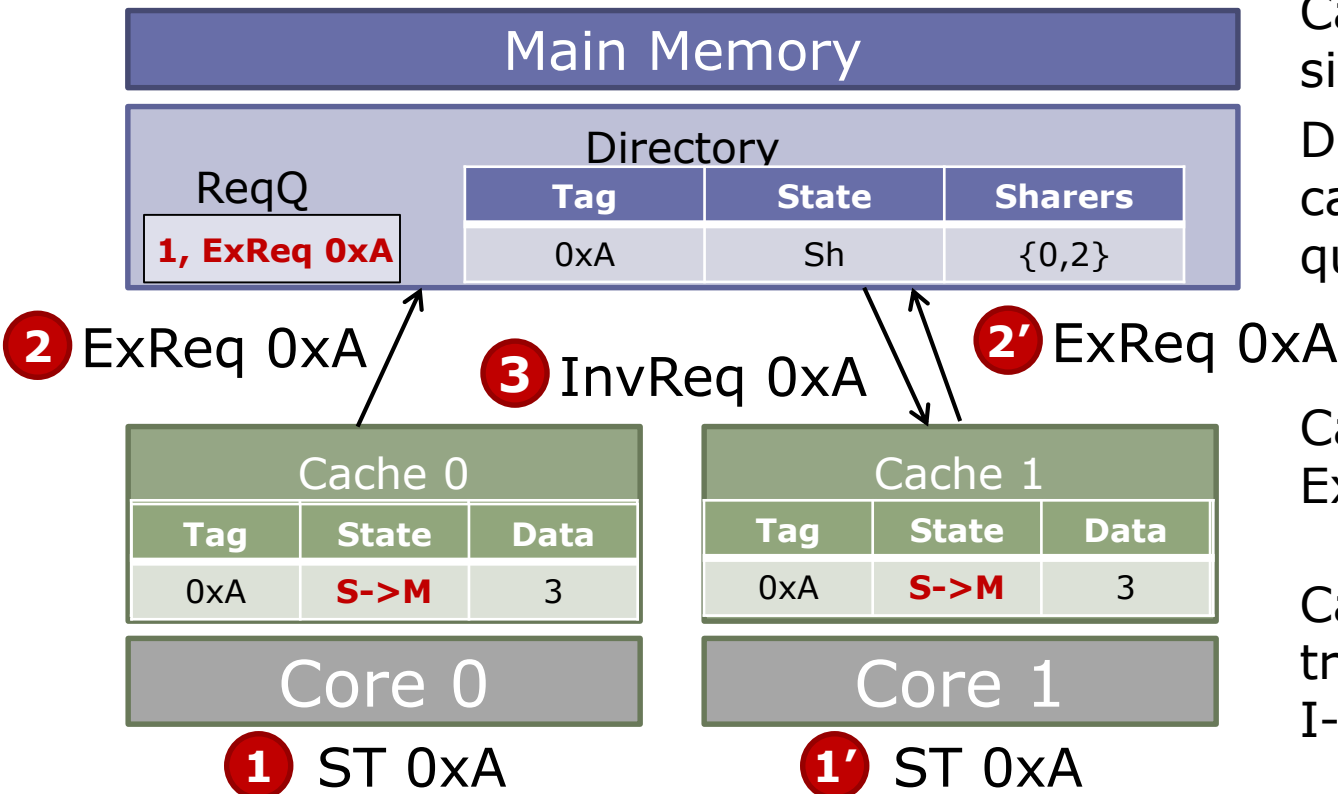

Caches 0 and 1 issue simultaneous ExReqs  
 Directory starts serving cache 0's ExReq, queues cache 1's

Cache 1 expected ExResp, but got InvReq!

Cache 1 should transition from S->M to I->M and send InvResp

# Extra Hops and 3-Hop Protocols

## Reducing Protocol Latency

---

- Problem: Data in another cache needs to pass through the directory, adding latency
- Optimization: Forward data to requester directly

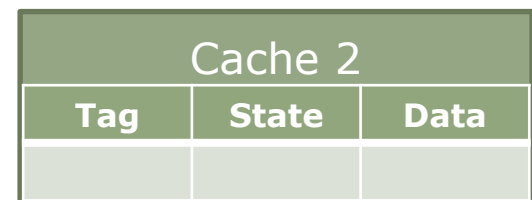
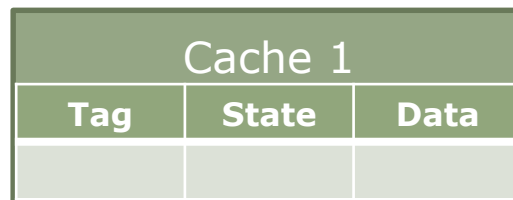
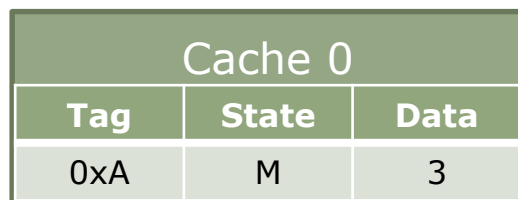
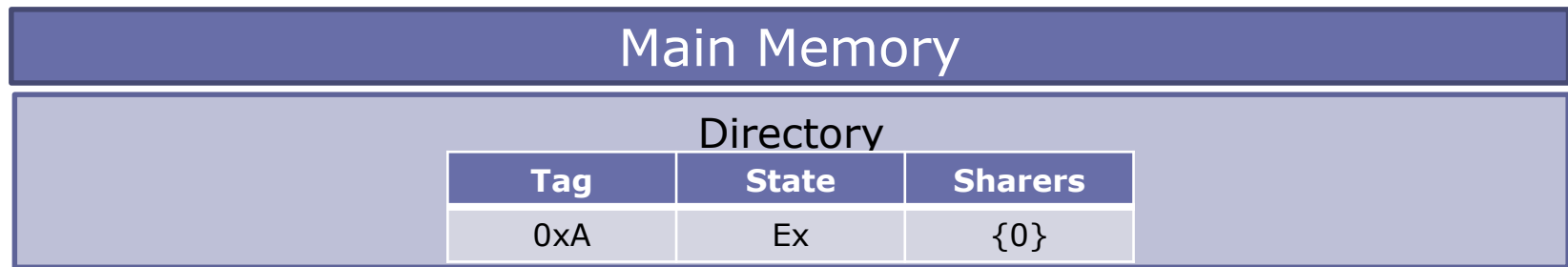

# Extra Hops and 3-Hop Protocols

## Reducing Protocol Latency

---

- Problem: Data in another cache needs to pass through the directory, adding latency
- Optimization: Forward data to requester directly

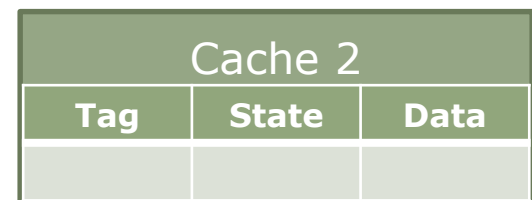
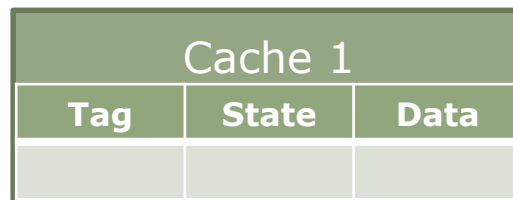
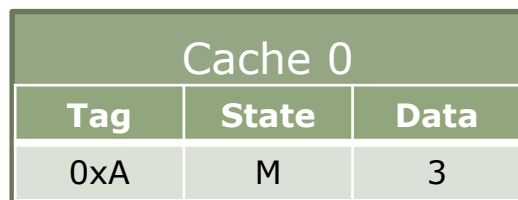
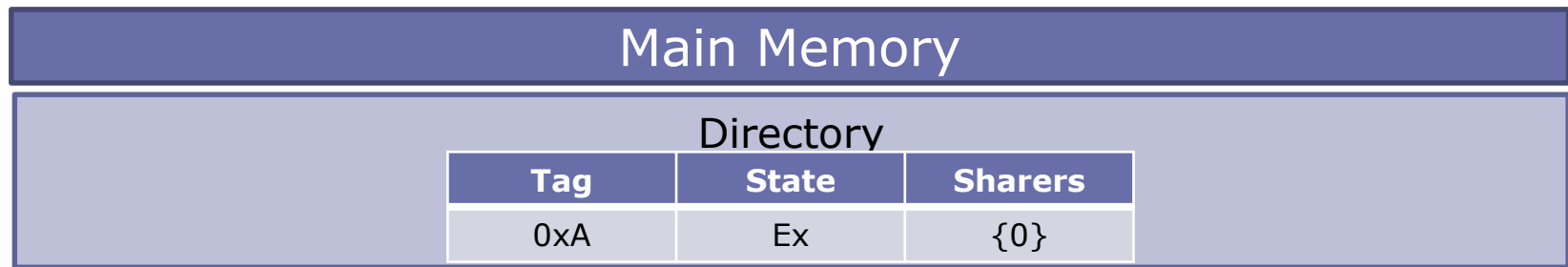

**1** ST 0xA

# Extra Hops and 3-Hop Protocols

## Reducing Protocol Latency

---

- Problem: Data in another cache needs to pass through the directory, adding latency
- Optimization: Forward data to requester directly

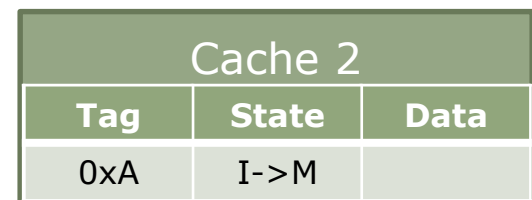
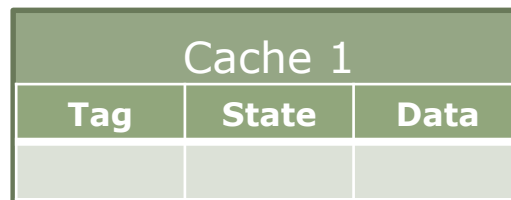
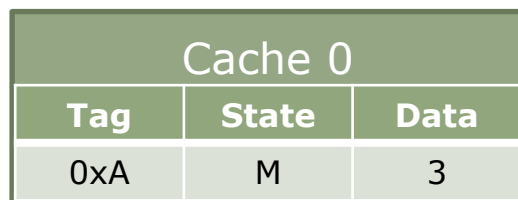
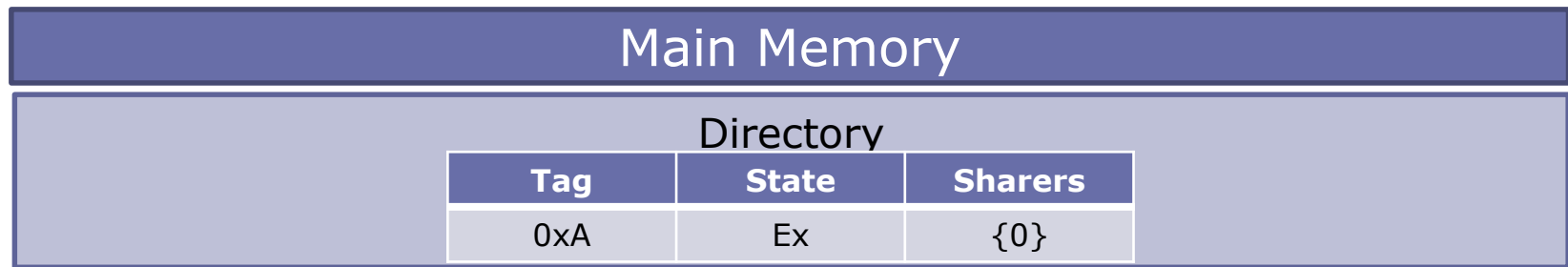

**1** ST 0xA

# Extra Hops and 3-Hop Protocols

## Reducing Protocol Latency

- Problem: Data in another cache needs to pass through the directory, adding latency
- Optimization: Forward data to requester directly

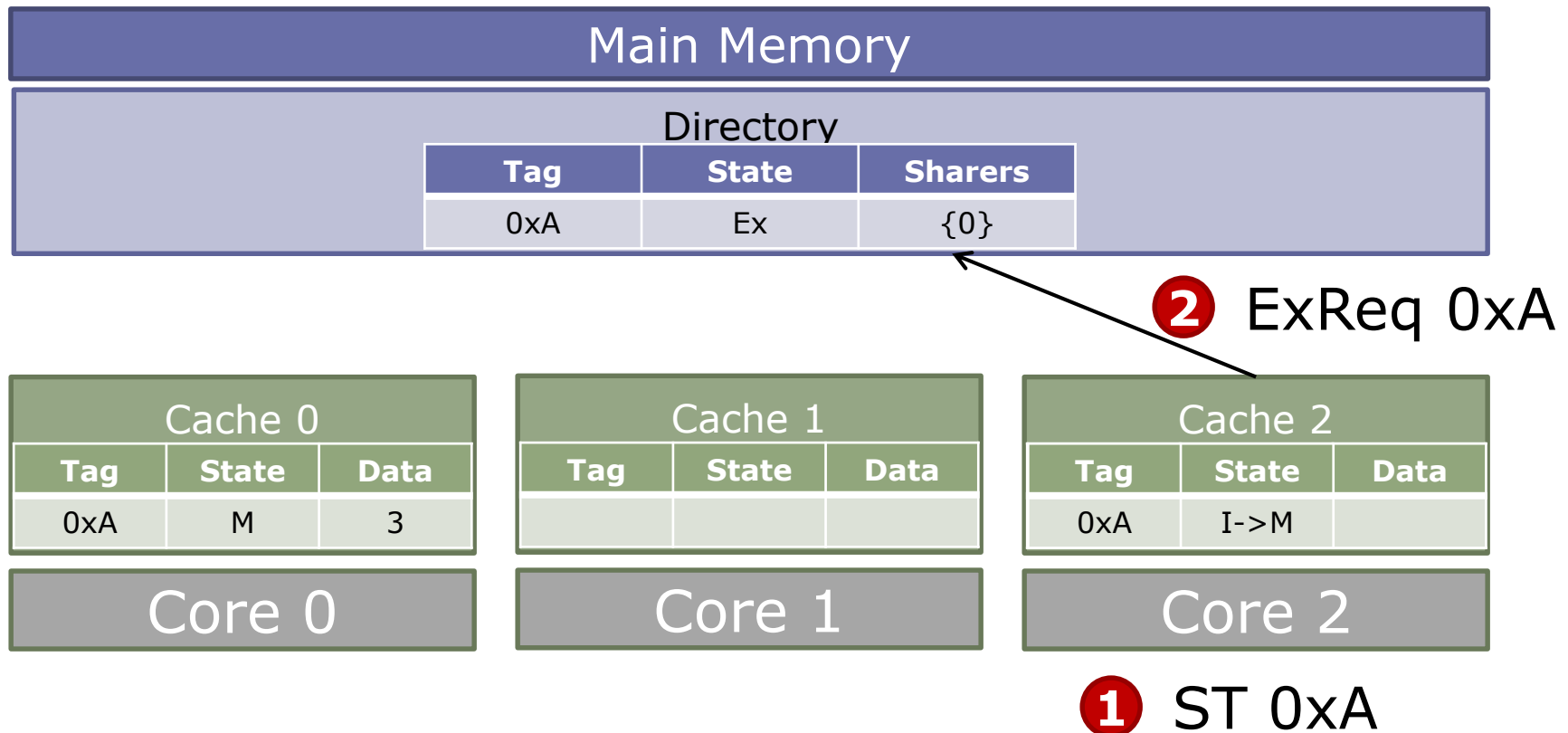

# Extra Hops and 3-Hop Protocols

## Reducing Protocol Latency

- Problem: Data in another cache needs to pass through the directory, adding latency
- Optimization: Forward data to requester directly

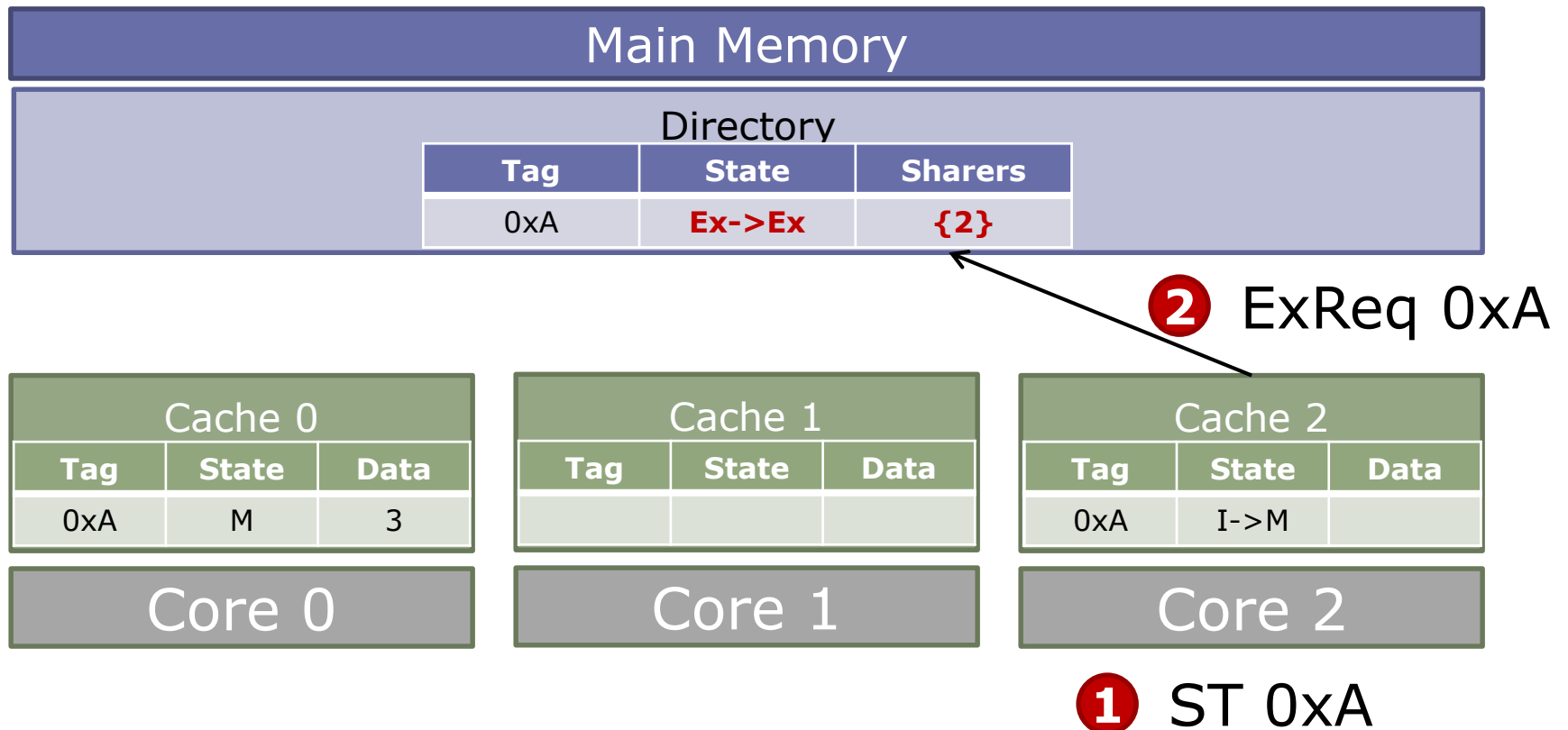

# Extra Hops and 3-Hop Protocols

## Reducing Protocol Latency

- Problem: Data in another cache needs to pass through the directory, adding latency
- Optimization: Forward data to requester directly

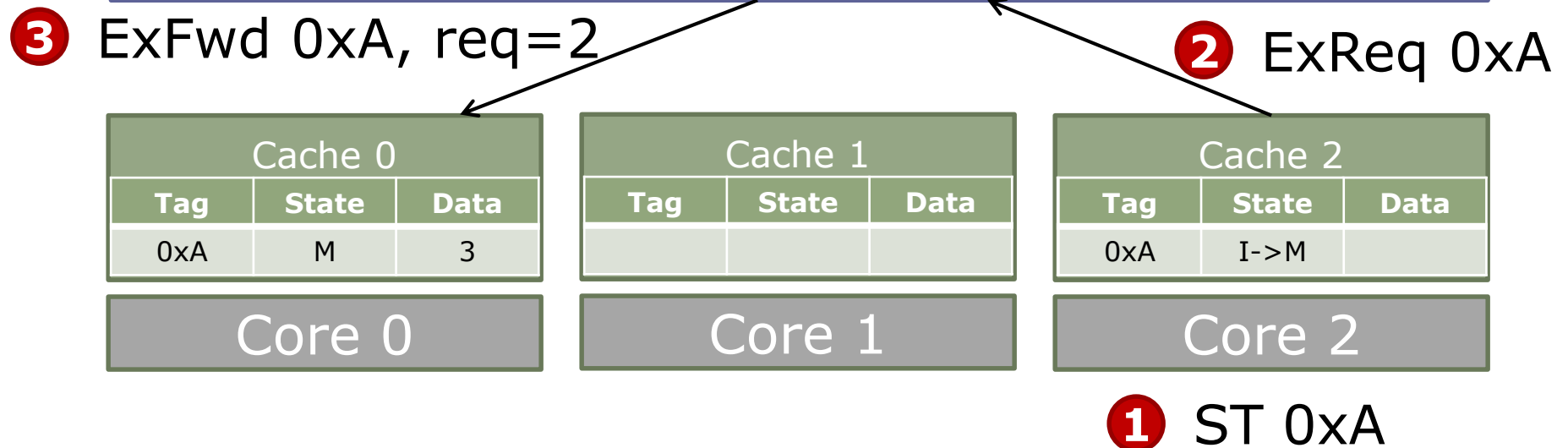
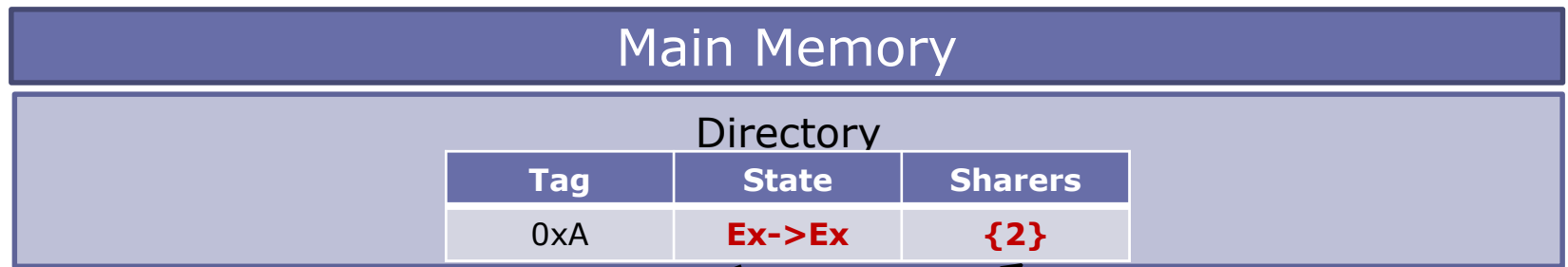

# Extra Hops and 3-Hop Protocols

## Reducing Protocol Latency

- Problem: Data in another cache needs to pass through the directory, adding latency
- Optimization: Forward data to requester directly

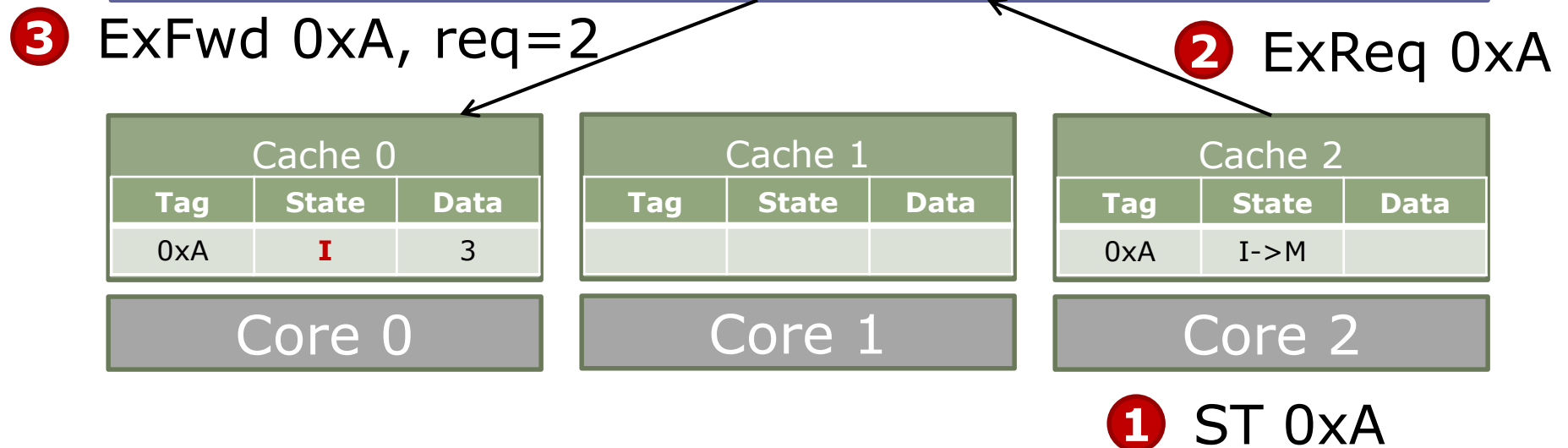
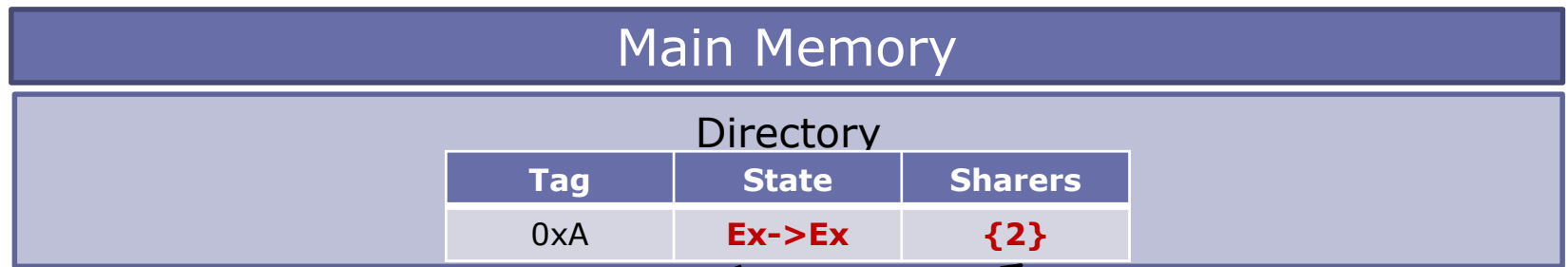



# Extra Hops and 3-Hop Protocols

## Reducing Protocol Latency

- Problem: Data in another cache needs to pass through the directory, adding latency
- Optimization: Forward data to requester directly

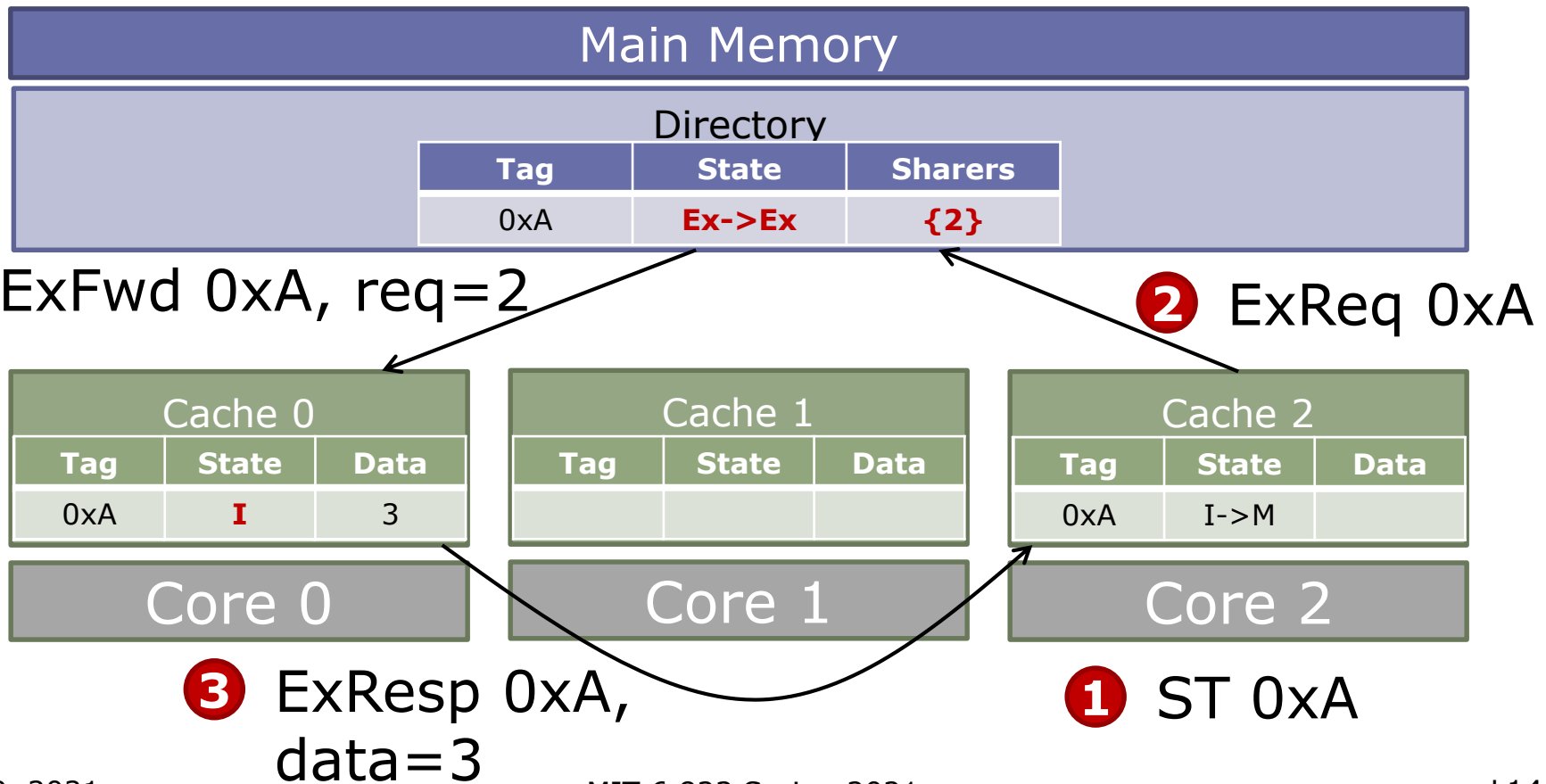

# Extra Hops and 3-Hop Protocols

## Reducing Protocol Latency

- Problem: Data in another cache needs to pass through the directory, adding latency
- Optimization: Forward data to requester directly

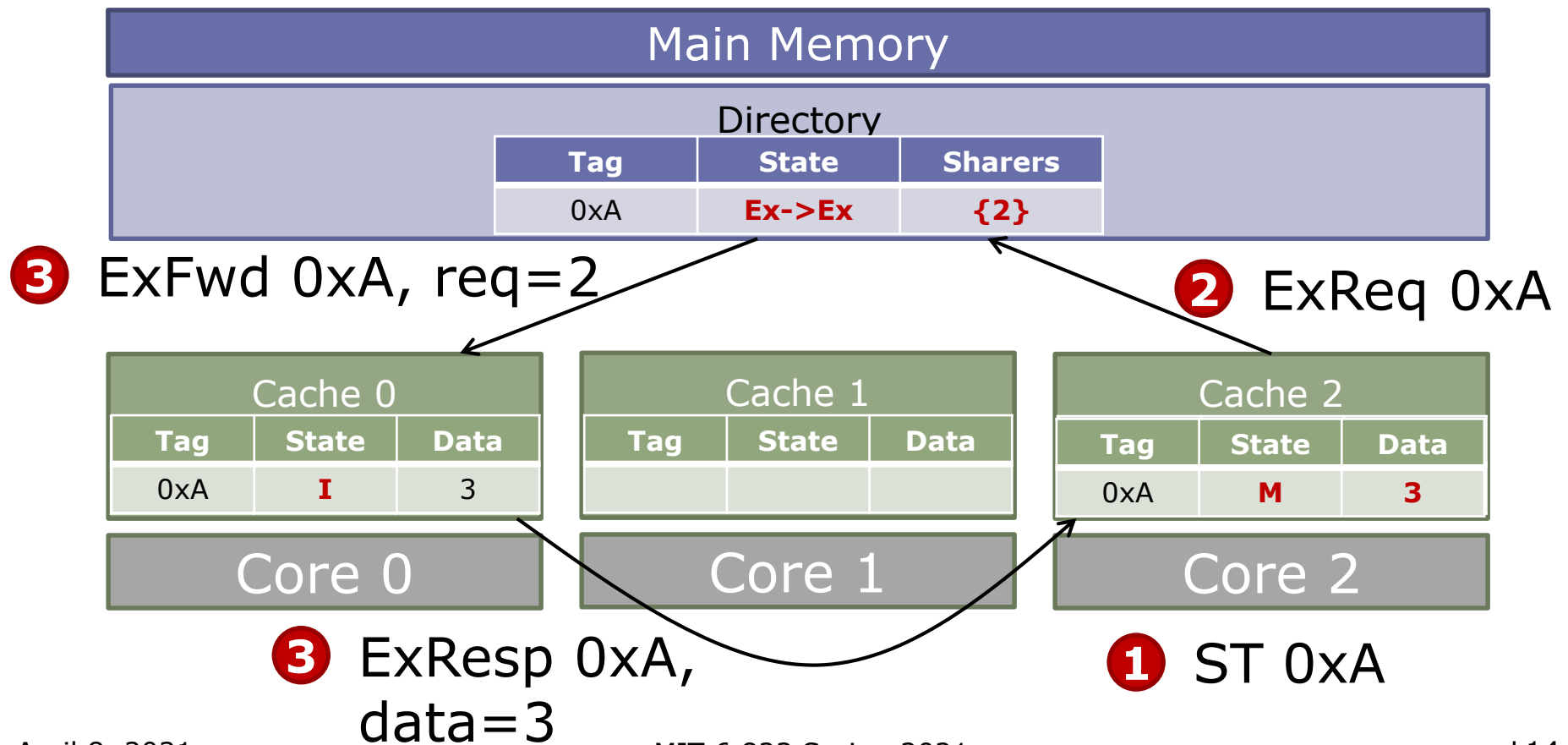

# Extra Hops and 3-Hop Protocols

## Reducing Protocol Latency

- Problem: Data in another cache needs to pass through the directory, adding latency
- Optimization: Forward data to requester directly

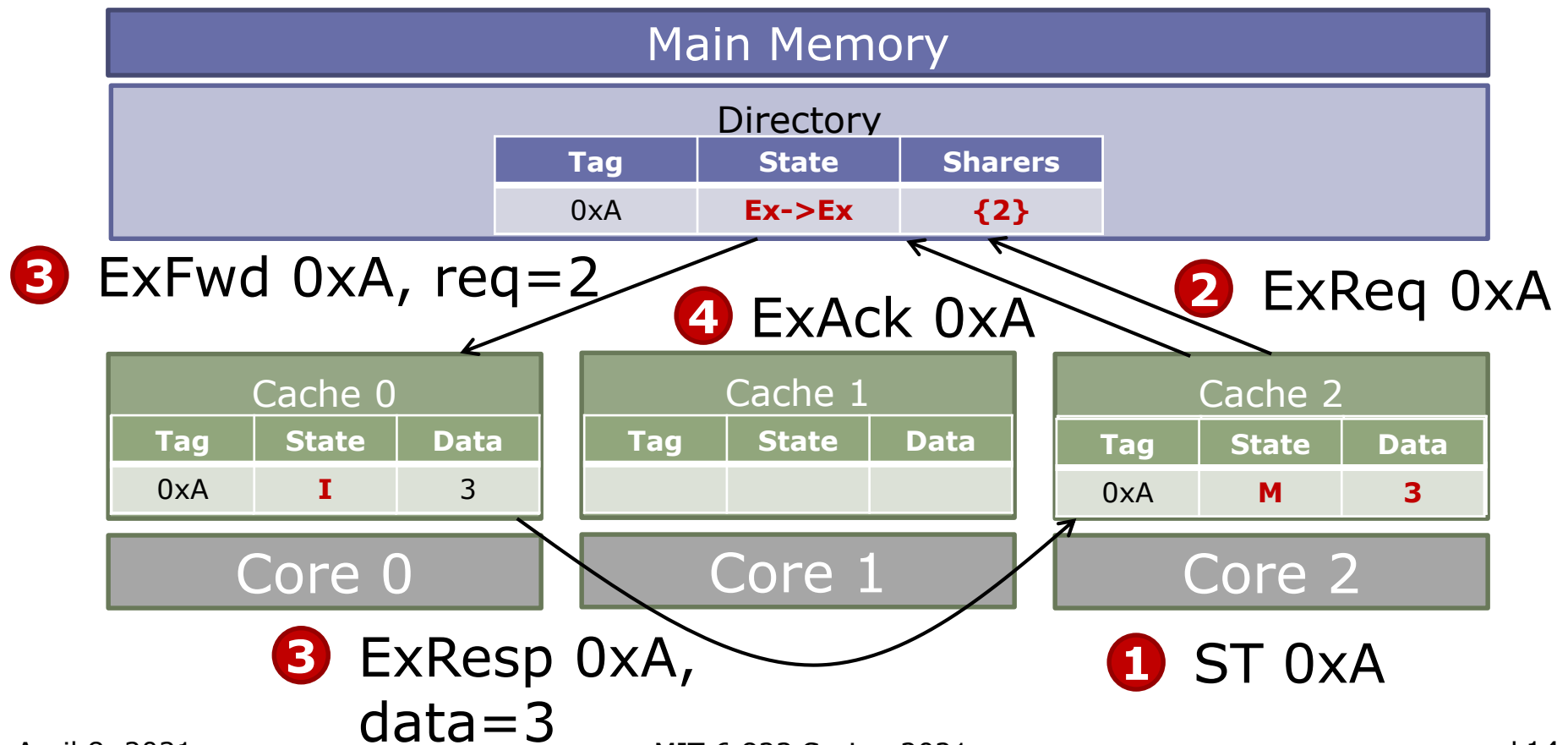

# Extra Hops and 3-Hop Protocols

## Reducing Protocol Latency

- Problem: Data in another cache needs to pass through the directory, adding latency
- Optimization: Forward data to requester directly

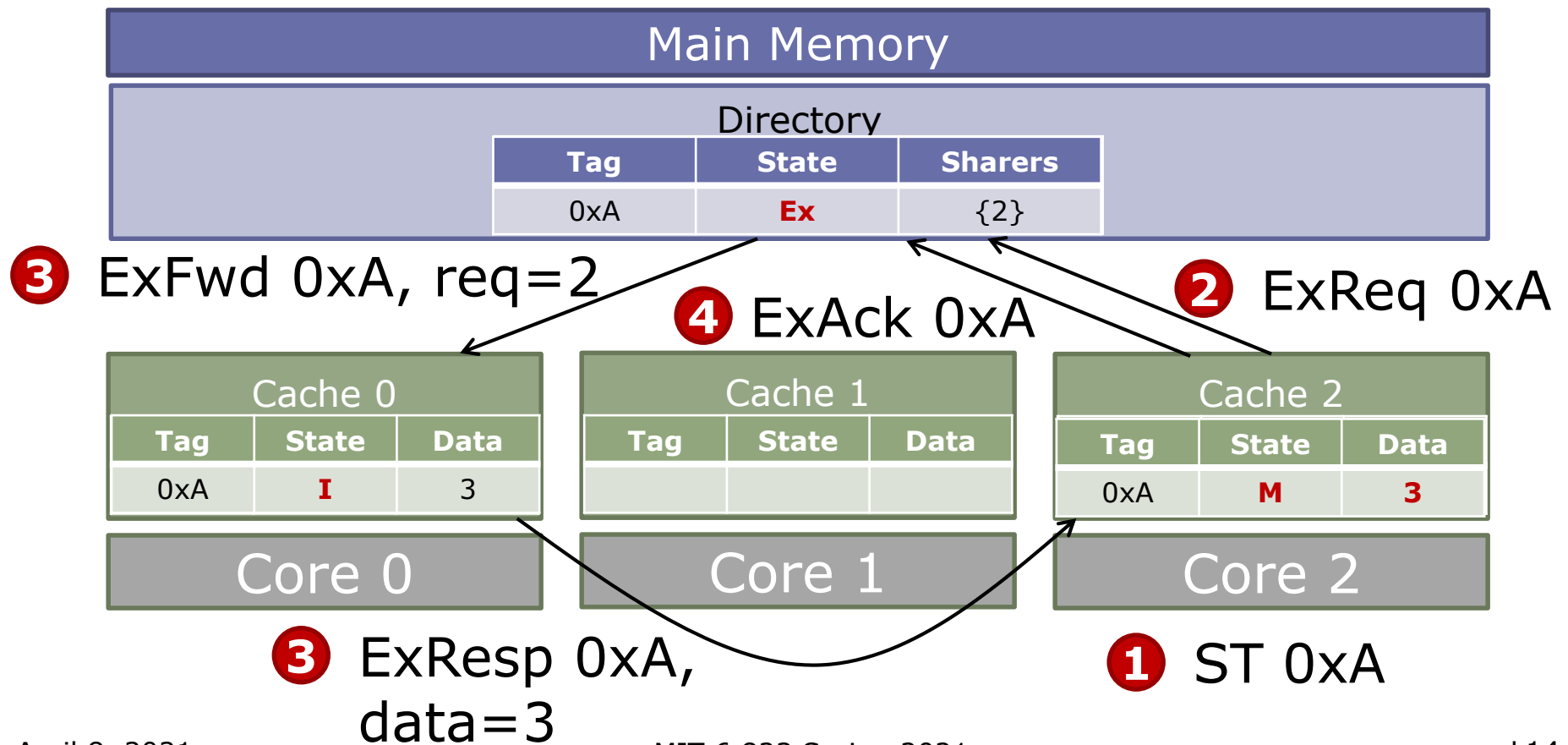

# Coherence in Multi-Level Hierarchies

- Can use the same or different protocols to keep coherence across multiple levels
- Key invariant: Ensure sufficient permissions in all intermediate levels
- Example: 8-socket Xeon E7 (8 cores/socket)

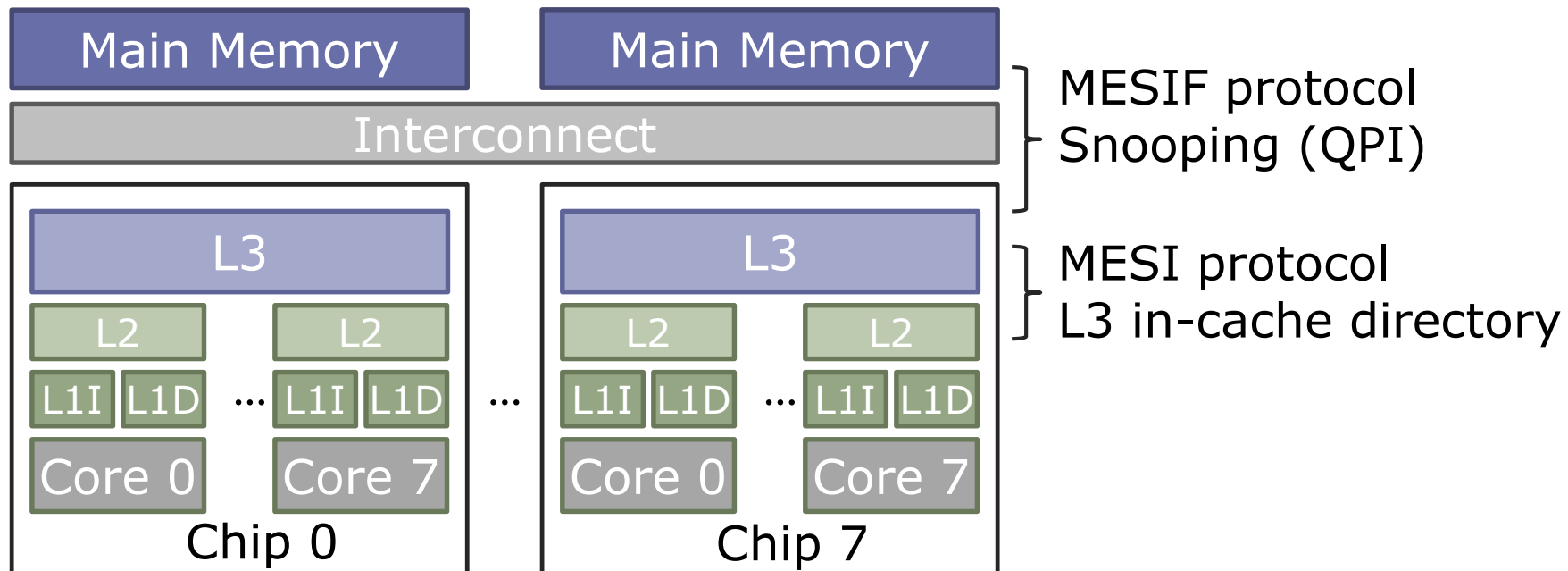

# In-Cache Directories

---

- Common multicore memory hierarchy:
  - 1+ levels of private caches
  - A shared last-level cache
  - Need to enforce coherence among private caches
- Idea: Embed the directory information in shared cache tags
  - Shared cache must be inclusive

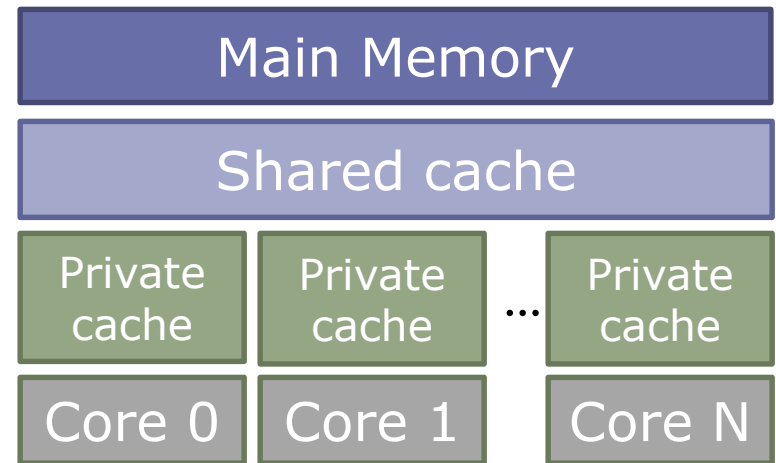

# In-Cache Directories

---

- Common multicore memory hierarchy:

- 1+ levels of private caches
- A shared last-level cache
- Need to enforce coherence among private caches

- Idea: Embed the directory information in shared cache tags

- Shared cache must be inclusive

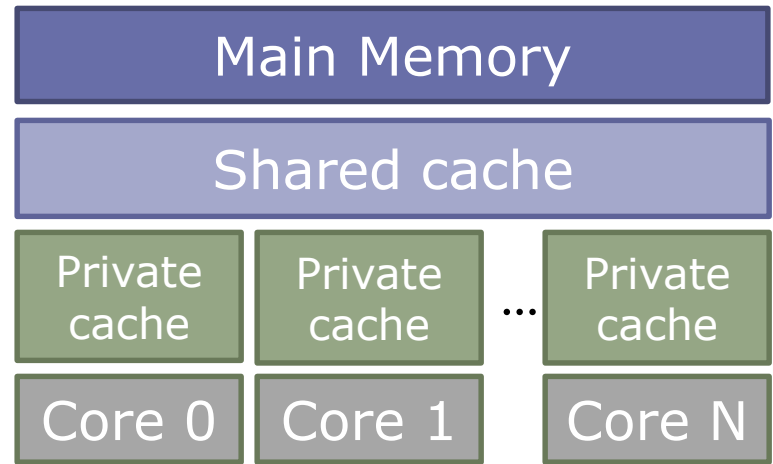

✓ Avoids tag overheads & separate lookups

✗ Can be inefficient if shared cache size  $\gg$  sum(private cache sizes)

# Avoiding Protocol Deadlock

---

- Protocols can cause deadlocks even if network is deadlock-free! (*more on this later*)

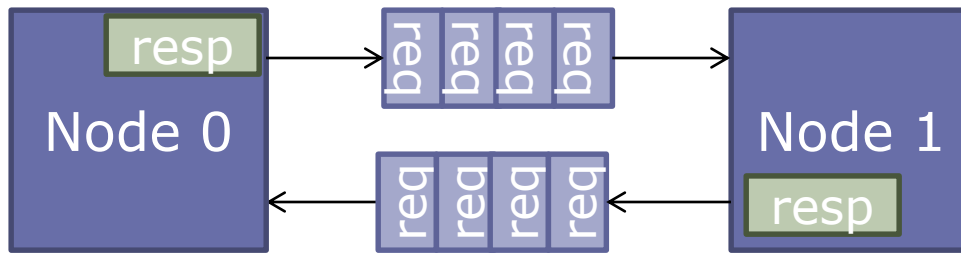

Example: Both nodes saturate all intermediate buffers with requests to each other, blocking responses from entering the network



# Avoiding Protocol Deadlock

---

- Protocols can cause deadlocks even if network is deadlock-free! (*more on this later*)

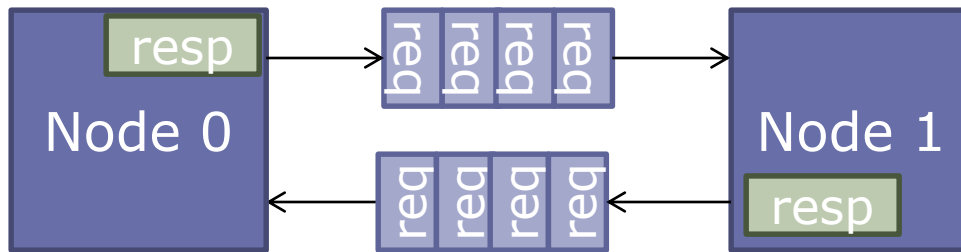

Example: Both nodes saturate all intermediate buffers with requests to each other, blocking responses from entering the network

- Solution: Separate *virtual networks*
  - Different sets of virtual channels and endpoint buffers
  - Same physical routers and links

# Avoiding Protocol Deadlock

---

- Protocols can cause deadlocks even if network is deadlock-free! (*more on this later*)

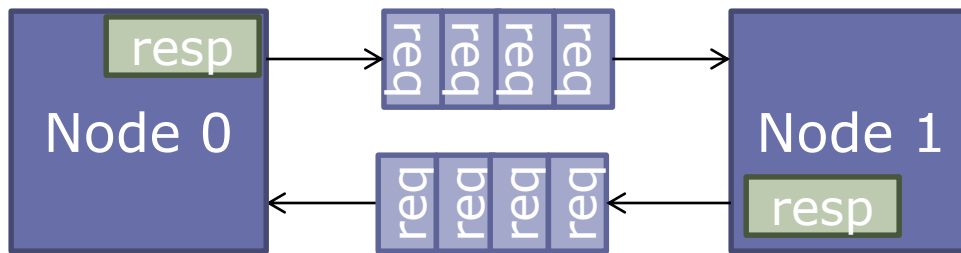

Example: Both nodes saturate all intermediate buffers with requests to each other, blocking responses from entering the network

- Solution: Separate *virtual networks*
  - Different sets of virtual channels and endpoint buffers
  - Same physical routers and links
- Most protocols require at least 2 virtual networks (for requests and replies), often  $>2$  needed

# Implementing Atomic Instructions

---

- In general, an *atomic read-modify-write* instruction requires two memory operations without intervening memory operations by other processors

# Implementing Atomic Instructions

---

- In general, an *atomic read-modify-write* instruction requires two memory operations without intervening memory operations by other processors
- Implementation options:
  - *With snoopy coherence, lock the bus -> expensive*

# Implementing Atomic Instructions

---

- In general, an *atomic read-modify-write* instruction requires two memory operations without intervening memory operations by other processors
- Implementation options:
  - *With snoopy coherence, lock the bus -> expensive*
  - *With directory-based coherence, lock the line in the cache (prevent invalidations or evictions until atomic op finishes) -> complex*

# Implementing Atomic Instructions

---

- In general, an *atomic read-modify-write* instruction requires two memory operations without intervening memory operations by other processors
- Implementation options:
  - *With snoopy coherence, lock the bus -> expensive*
  - *With directory-based coherence, lock the line in the cache (prevent invalidations or evictions until atomic op finishes) -> complex*
- Modern processors often use
  - load-reserve*
  - store-conditional*

# Load-reserve & Store-conditional

---

Special register(s) to hold reservation flag and address, and the outcome of store-conditional

```
Load-reserve R, (a):  
  <flag, adr> ← <1, a>;  
  R ← M[a];
```

```
Store-conditional (a), R:  
  if <flag, adr> == <1, a>  
  then cancel other procs'  
    reservation on a;  
    M[a] ← <R>;  
    status ← succeed;  
  else status ← fail;
```

If the cache receives an invalidation to the address in the reserve register, the reserve bit is set to **0**

- Several processors may reserve 'a' simultaneously
- These instructions are like ordinary loads and stores with respect to the bus traffic

# Load-Reserve/Store-Conditional

---

Swap implemented with Ld-Reserve/St-Conditional

# Swap(R1, mutex):

L: Ld-Reserve R2, (mutex)  
St-Conditional (mutex), R1  
if (status == fail) goto L  
R1 <- R2



# Performance:

## *Load-reserve & Store-conditional*

---

The total number of coherence transactions is not necessarily reduced, but splitting an atomic instruction into load-reserve & store-conditional:

- *increases utilization* (and reduces processor stall time), especially in split-transaction buses and directories
- *reduces cache ping-pong effect* because processors trying to acquire a semaphore do not have to perform stores each time

*Thank you!*

*Next Lecture:  
Consistency and  
Relaxed Memory Models*