

Transactional Memory

Daniel Sanchez

Computer Science & Artificial Intelligence Lab
M.I.T.

Based on slides from Christos Kozyrakis

Reminder: Why Multicore?

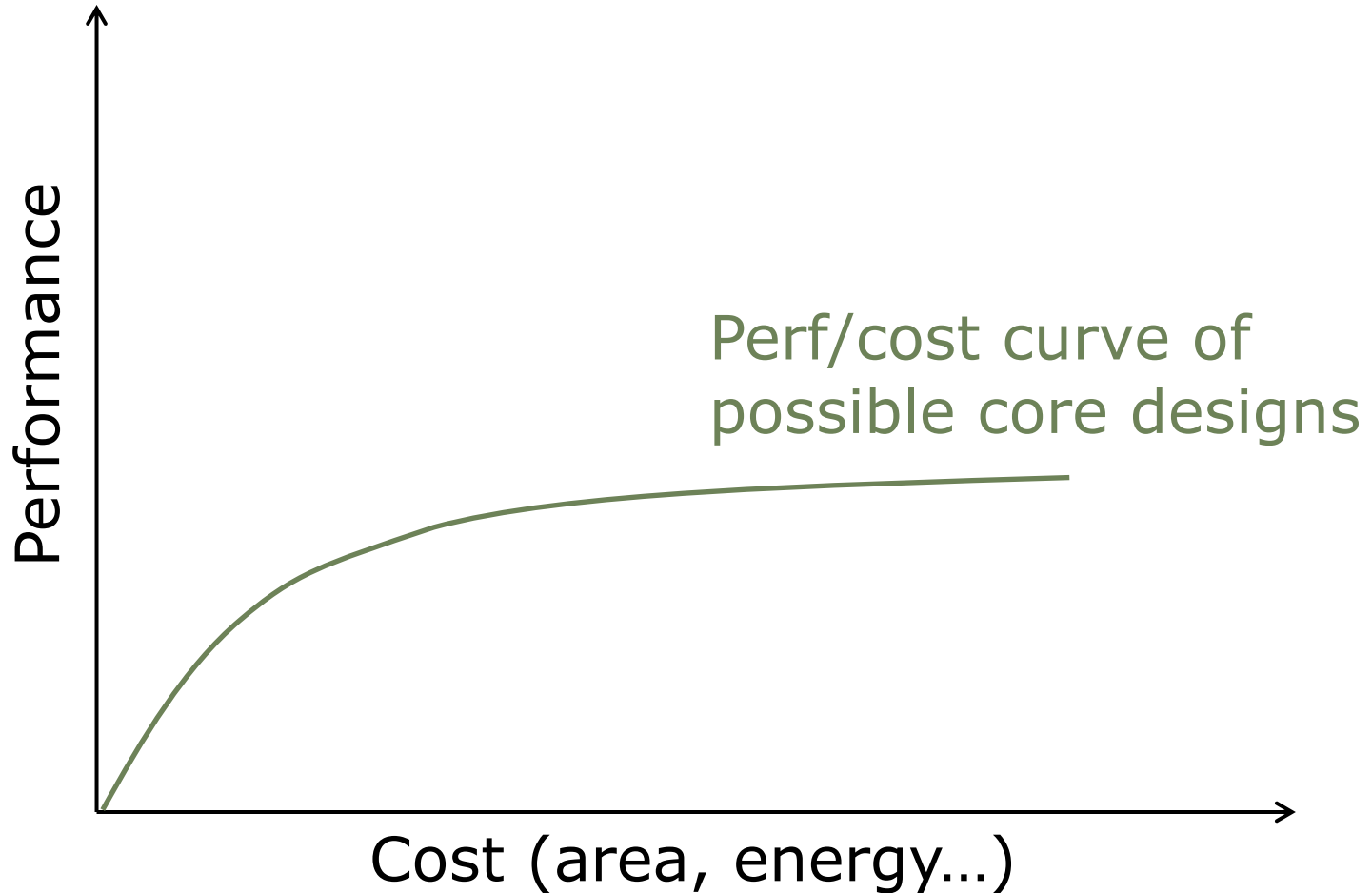

Reminder: Why Multicore?

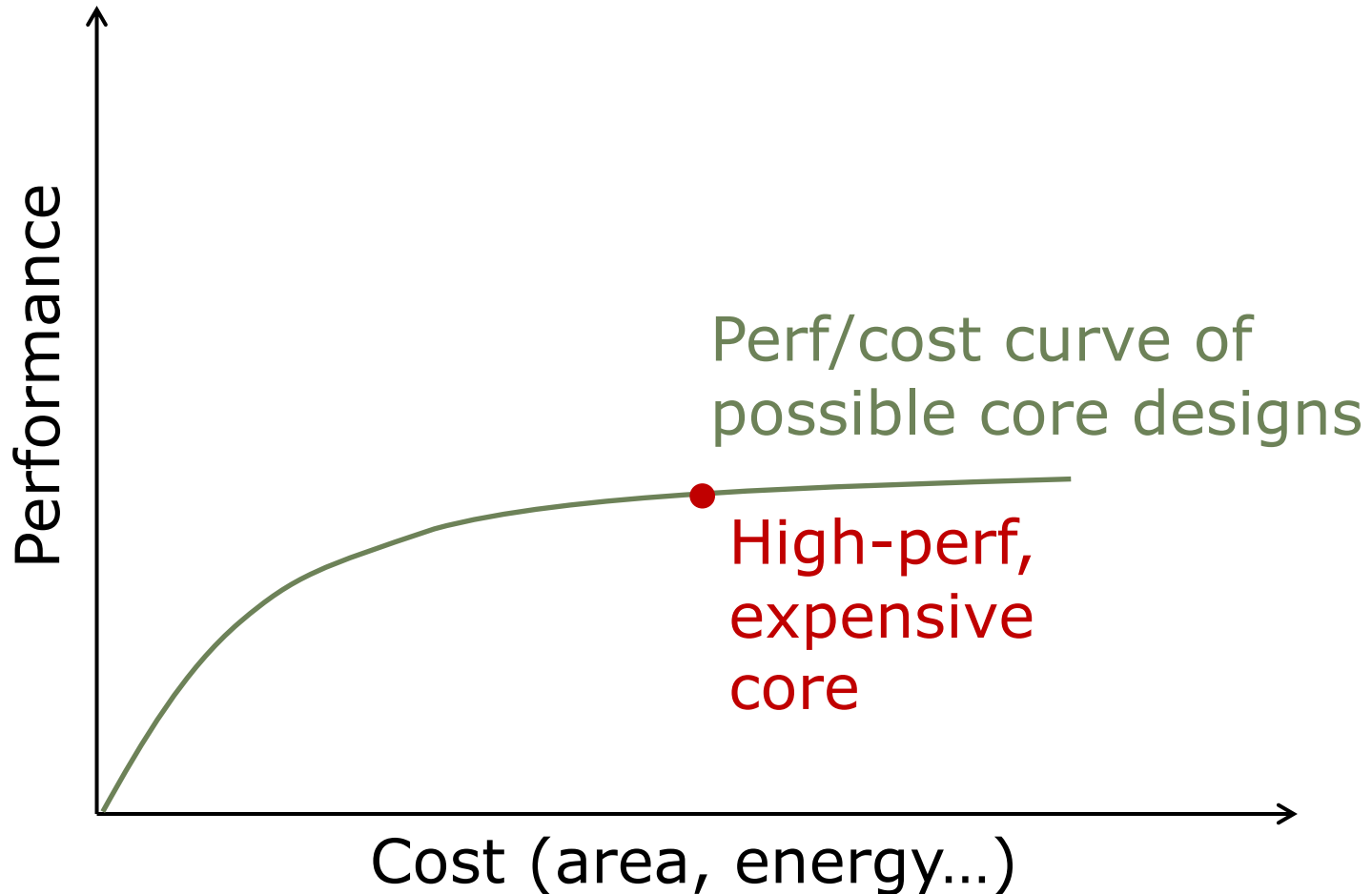

Reminder: Why Multicore?

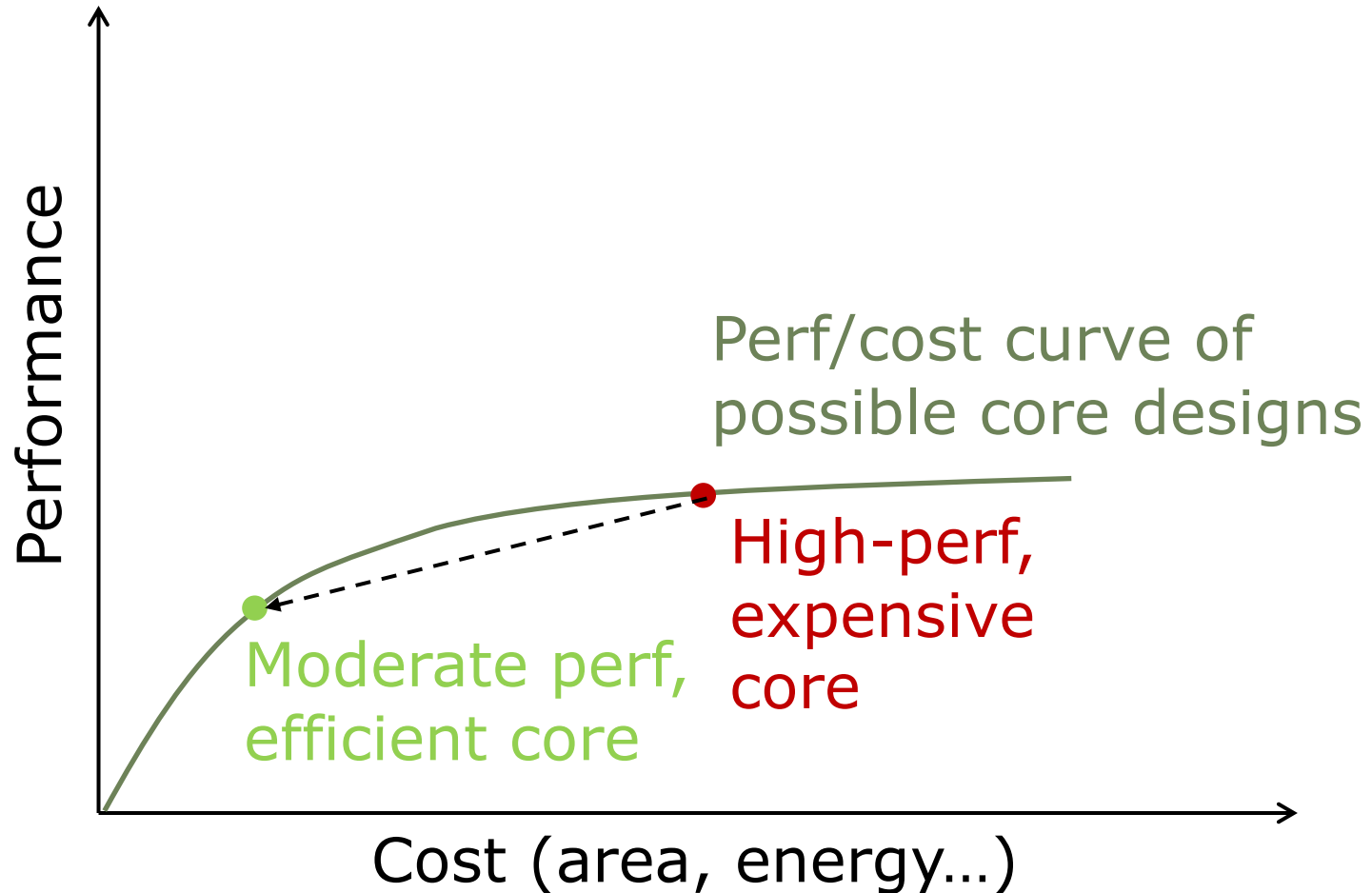

Reminder: Why Multicore?

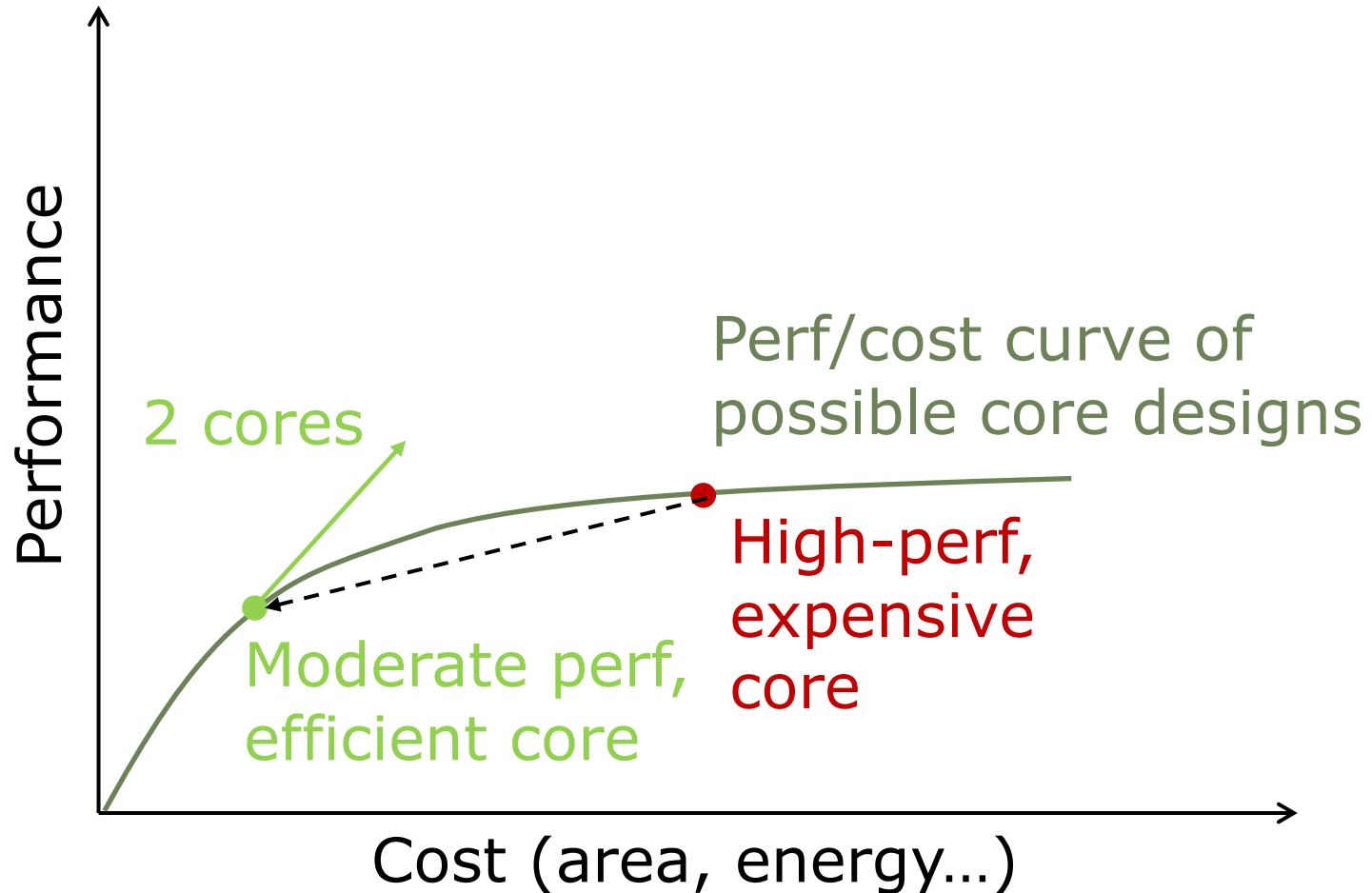

Reminder: Why Multicore?

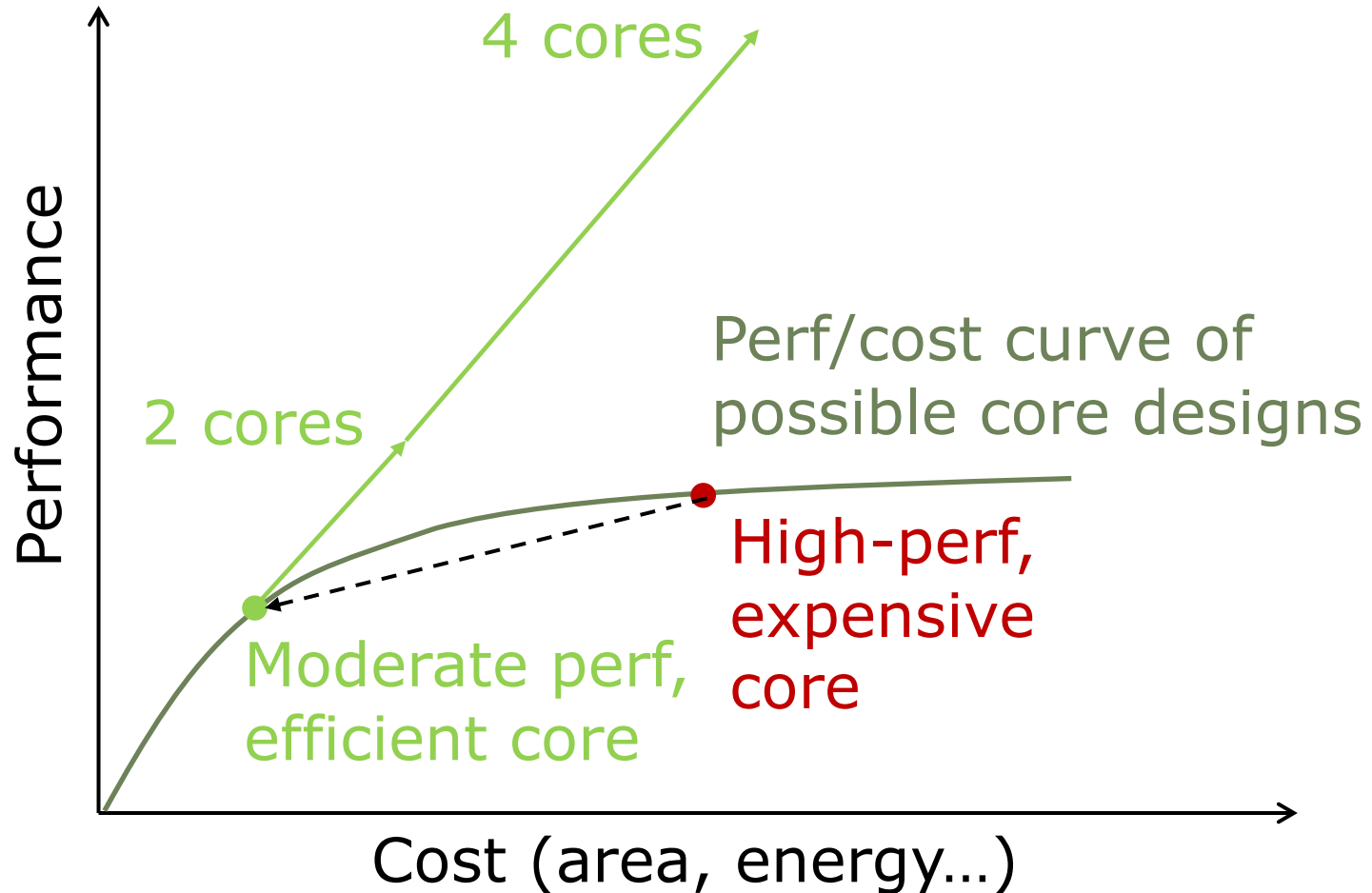

But Parallel Programming is HARD

- Divide algorithm into tasks
- Map tasks to threads
- Add synchronization (locks, barriers, ...) to avoid data races and ensure proper task ordering

But Parallel Programming is HARD

- Divide algorithm into tasks
 - Map tasks to threads
 - Add synchronization (locks, barriers, ...) to avoid data races and ensure proper task ordering
-
- Pitfalls: scalability, locality, deadlock, livelock, fairness, races, composability, portability...

Example: Hash Table

- Sequential implementation:

```
V lookup(K key) {  
    int idx = hash(key);  
    for (;;) {  
        if (buckets[idx].empty)  
            return NOT_FOUND;  
        if (buckets[idx].key == key)  
            return buckets[idx].val;  
    }  
}
```

Example: Hash Table

- Sequential implementation:

```
V lookup(K key) {
  int idx = hash(key);
  for (;;) {
    if (buckets[idx].empty)
      return NOT_FOUND;
    if (buckets[idx].key == key)
      return buckets[idx].val;
  }
}
```

- Not thread-safe

- e.g., concurrent inserts and lookups cause races
- Need synchronization

Thread-Safe Hash Table with Coarse-Grain Locks

```
V lookup(K key) {
    int idx = hash(key);
    V result = NOT_FOUND;
    lock(mutex);
    for (;;) {
        if (buckets[idx].empty) break;
        if (buckets[idx].key == key) {
            result = buckets[idx].val;
            break;
        }
    }
    unlock(mutex);
    return result;
}
```

- Also add lock(mutex)/unlock(mutex) pairs to all other hash table methods (insert, remove, ...)

Thread-Safe Hash Table with Coarse-Grain Locks

```
V lookup(K key) {
    int idx = hash(key);
    V result = NOT_FOUND;
    lock(mutex);
    for (;;) {
        if (buckets[idx].empty) break;
        if (buckets[idx].key == key) {
            result = buckets[idx].val;
            break;
        }
    }
    unlock(mutex);
    return result;
}
```

- Also add lock(mutex)/unlock(mutex) pairs to all other hash table methods (insert, remove, ...)
- *Problem?*

Thread-Safe Hash Table with Coarse-Grain Locks

```
V lookup(K key) {
    int idx = hash(key);
    V result = NOT_FOUND;
    lock(mutex);
    for (;;) {
        if (buckets[idx].empty) break;
        if (buckets[idx].key == key) {
            result = buckets[idx].val;
            break;
        }
    }
    unlock(mutex);
    return result;
}
```

- Also add lock(mutex)/unlock(mutex) pairs to all other hash table methods (insert, remove, ...)
- *Problem?* Serializes operations to independent buckets

Thread-Safe Hash Table with Fine-Grain Locks

```
V lookup(K key) {
    int idx = hash(key);
    V result = NOT_FOUND;
    for (;;) {
        lock(buckets[idx].mutex);
        if (buckets[idx].empty) {
            unlock(buckets[idx].mutex);
            break;
        }
        if (buckets[idx].key == key) {
            result = buckets[idx].val;
            unlock(buckets[idx].mutex);
            break;
        }
        unlock(buckets[idx].mutex);
    }
    return result;
}
```

- Per-bucket locks

Thread-Safe Hash Table with Fine-Grain Locks

```
V lookup(K key) {
    int idx = hash(key);
    V result = NOT_FOUND;
    for (;;) {
        lock(buckets[idx].mutex);
        if (buckets[idx].empty) {
            unlock(buckets[idx].mutex);
            break;
        }
        if (buckets[idx].key == key) {
            result = buckets[idx].val;
            unlock(buckets[idx].mutex);
            break;
        }
        unlock(buckets[idx].mutex);
    }
    return result;
}
```

- Per-bucket locks
- *Problems?*

Thread-Safe Hash Table with Fine-Grain Locks

```
V lookup(K key) {
    int idx = hash(key);
    V result = NOT_FOUND;
    for (;;) {
        lock(buckets[idx].mutex);
        if (buckets[idx].empty) {
            unlock(buckets[idx].mutex);
            break;
        }
        if (buckets[idx].key == key) {
            result = buckets[idx].val;
            unlock(buckets[idx].mutex);
            break;
        }
        unlock(buckets[idx].mutex);
    }
    return result;
}
```

- Per-bucket locks
- *Problems?*

Locking overheads

Thread-Safe Hash Table with Fine-Grain Locks

```
V lookup(K key) {
    int idx = hash(key);
    V result = NOT_FOUND;
    for (;;) {
        lock(buckets[idx].mutex);
        if (buckets[idx].empty) {
            unlock(buckets[idx].mutex);
            break;
        }
        if (buckets[idx].key == key) {
            result = buckets[idx].val;
            unlock(buckets[idx].mutex);
            break;
        }
        unlock(buckets[idx].mutex);
    }
    return result;
}
```

- Per-bucket locks
- *Problems?*

Locking overheads

Still overserializes!
(e.g., concurrent reads
to the same bucket)

Performance: Locks

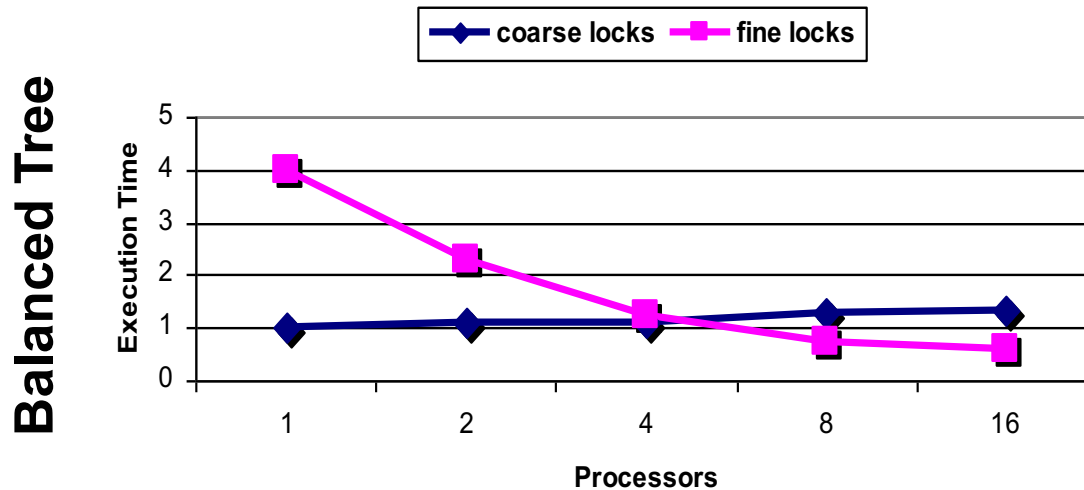
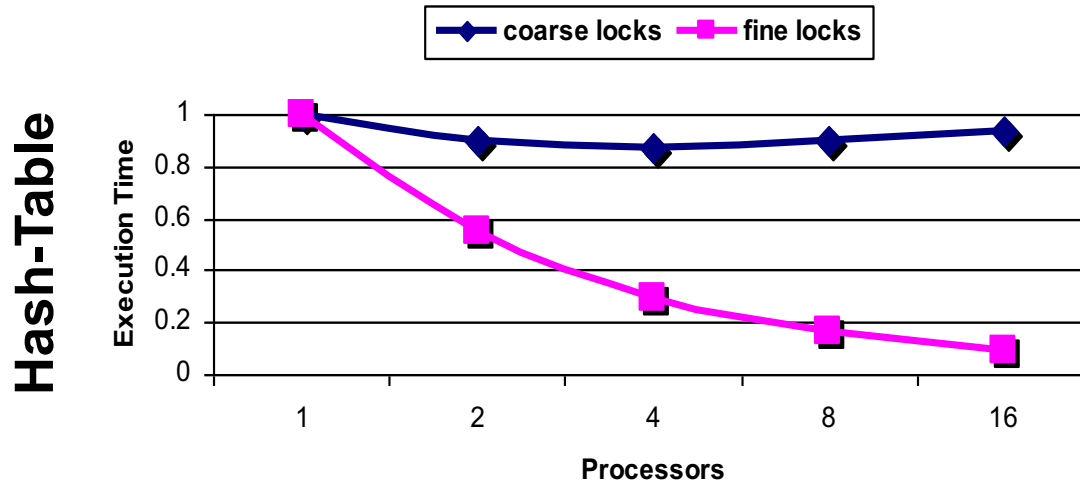

Concurrency Control

- We need to implement concurrency control to avoid **races** on shared data!
- Options?

Concurrency Control

- We need to implement concurrency control to avoid **races** on shared data!
- Options?
 - Stall
 - Mutual exclusion: Ensure at most one process in critical section; others wait

Concurrency Control

- We need to implement concurrency control to avoid **races** on shared data!
- Options?
 - Stall
 - Mutual exclusion: Ensure at most one process in critical section; others wait
 - Speculate

Concurrency Control

- We need to implement concurrency control to avoid **races** on shared data!
- Options?
 - Stall
 - Mutual exclusion: Ensure at most one process in critical section; others wait
 - Speculate
 - Guess: No conflicts will occur during the critical section

Concurrency Control

- We need to implement concurrency control to avoid **races** on shared data!
- Options?
 - Stall
 - Mutual exclusion: Ensure at most one process in critical section; others wait
 - Speculate
 - Guess: No conflicts will occur during the critical section
 - Check: Detect whether conflicting data accesses occur

Concurrency Control

- We need to implement concurrency control to avoid **races** on shared data!
- Options?
 - Stall
 - Mutual exclusion: Ensure at most one process in critical section; others wait
 - Speculate
 - Guess: No conflicts will occur during the critical section
 - Check: Detect whether conflicting data accesses occur
 - Recover: If conflict occurs, roll back; otherwise commit

Transactional Memory (TM)

- Memory transaction [Lomet'77, Knight'86, Herlihy & Moss'93]
 - An atomic & isolated sequence of memory accesses
 - Inspired by database transactions
- Atomicity (all or nothing)
 - At commit, all memory writes take effect at once
 - On abort, none of the writes appear to take effect
- Isolation
 - No other code can observe writes before commit
- Serializability
 - Transactions seem to commit in a single serial order
 - The exact order is not guaranteed

Programming with TM

```
void deposit(account, amount) {  
    lock(account.mutex);  
    int t = bank.get(account);  
    t = t + amount;  
    bank.put(account, t);  
    unlock(account.mutex);  
}
```



```
void deposit(account, amount) {  
    atomic {  
        int t = bank.get(account);  
        t = t + amount;  
        bank.put(account, t);  
    }  
}
```

Programming with TM

```
void deposit(account, amount) {  
    lock(account.mutex);  
    int t = bank.get(account);  
    t = t + amount;  
    bank.put(account, t);  
    unlock(account.mutex);  
}
```



```
void deposit(account, amount) {  
    atomic {  
        int t = bank.get(account);  
        t = t + amount;  
        bank.put(account, t);  
    }  
}
```

- Declarative synchronization
 - Programmers says what but not how
 - No declaration or management of locks
- System implements synchronization
 - Typically through speculation
 - Performance hit only on conflicts (R-W or W-W)

Advantages of TM

- Easy-to-use synchronization
 - As easy to use as coarse-grain locks
 - Programmer declares, system implements
- High performance
 - Performs at least as well as fine-grain locks
 - Automatic read-read & fine-grain concurrency
 - No tradeoff between performance & correctness
- Composability
 - Safe & scalable composition of software modules (nested transactions)

Performance: Locks vs Transactions

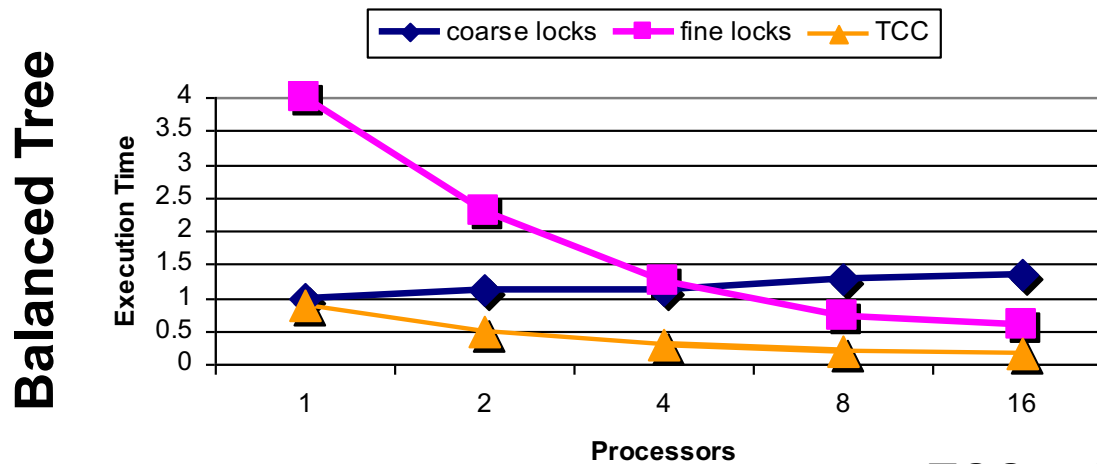
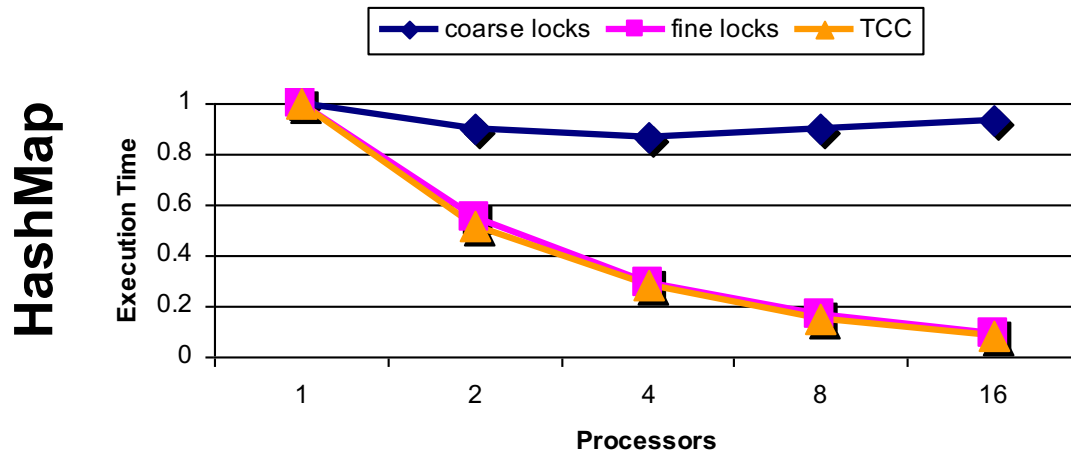

TCC: a HW-based TM system
[Hammond et al, ISCA'04]

TM Implementation Basics

- Use speculation to provide atomicity and isolation without sacrificing concurrency
- Basic implementation requirements
 - Data versioning
 - Conflict detection & resolution
- Implementation options
 - Hardware transactional memory (HTM)
 - Software transactional memory (STM)
 - Hybrid transactional memory
 - Hardware accelerated STMs and dual-mode systems

Motivation for Hardware TM

- Single-thread software TM performance:

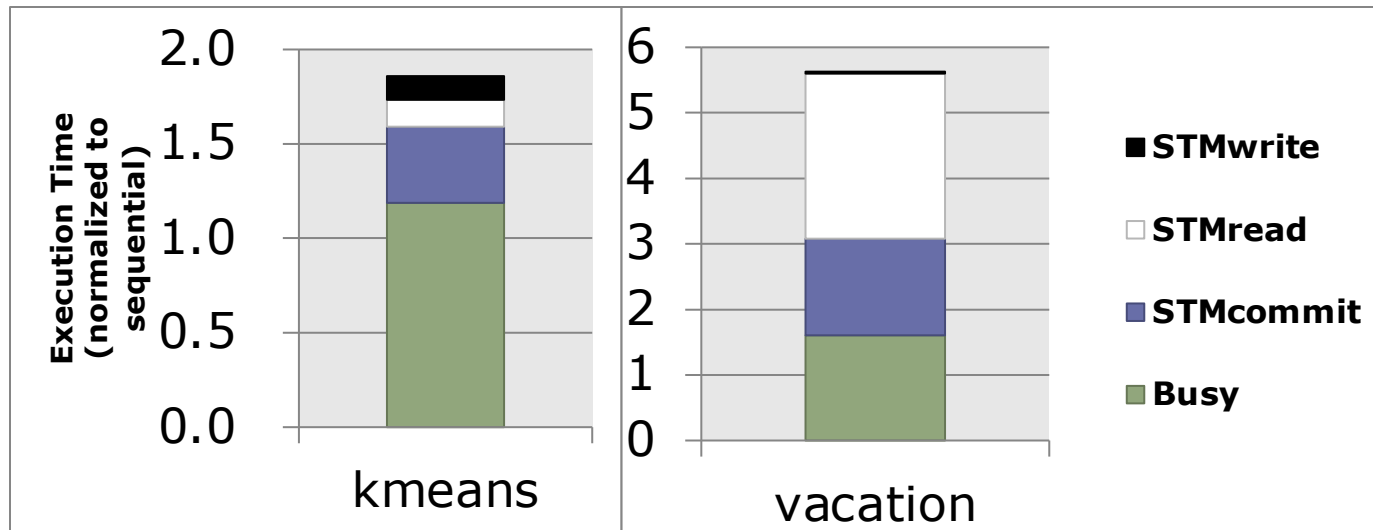

- Software TM suffers 2-8x slowdown over sequential
 - Short-term issue: demotivates parallel programming
 - Long-term issue: not energy-efficient
- Industry adopting Hardware TM: Intel (since Haswell), IBM (POWER8+, Blue Gene, zSeries), ARM (v9)

Data Management Policy

- Manage **uncommitted** (new) and **committed** (old) versions of data for concurrent transactions

Data Management Policy

- Manage **uncommitted** (new) and **committed** (old) versions of data for concurrent transactions
1. Eager versioning (undo-log based)

Data Management Policy

- Manage **uncommitted** (new) and **committed** (old) versions of data for concurrent transactions
1. Eager versioning (undo-log based)
 - Update memory location directly

Data Management Policy

- Manage **uncommitted** (new) and **committed** (old) versions of data for concurrent transactions
1. Eager versioning (undo-log based)
 - Update memory location directly
 - Maintain undo info in a log
 - + **Fast commits**
 - **Slow aborts**

Data Management Policy

- Manage **uncommitted** (new) and **committed** (old) versions of data for concurrent transactions
1. Eager versioning (undo-log based)
 - Update memory location directly
 - Maintain undo info in a log
 - + Fast commits
 - Slow aborts
 2. Lazy versioning (write-buffer based)

Data Management Policy

- Manage **uncommitted** (new) and **committed** (old) versions of data for concurrent transactions
1. Eager versioning (undo-log based)
 - Update memory location directly
 - Maintain undo info in a log
 - + **Fast commits**
 - **Slow aborts**
 2. Lazy versioning (write-buffer based)
 - Buffer data until commit in a write buffer

Data Management Policy

- Manage **uncommitted** (new) and **committed** (old) versions of data for concurrent transactions
1. Eager versioning (undo-log based)
 - Update memory location directly
 - Maintain undo info in a log
 - + **Fast commits**
 - **Slow aborts**
 2. Lazy versioning (write-buffer based)
 - Buffer data until commit in a write buffer
 - Update actual memory locations at commit
 - + **Fast aborts**
 - **Slow commits**

Eager Versioning Illustration

Begin Xaction

Thread

Undo
Log

X: 10

Memory

Eager Versioning Illustration

Begin Xaction

Thread

Undo Log

X: 10

Memory

Write X ← 15

Thread



Undo Log
X: 10

X: 15

Memory

Eager Versioning Illustration

Begin Xaction

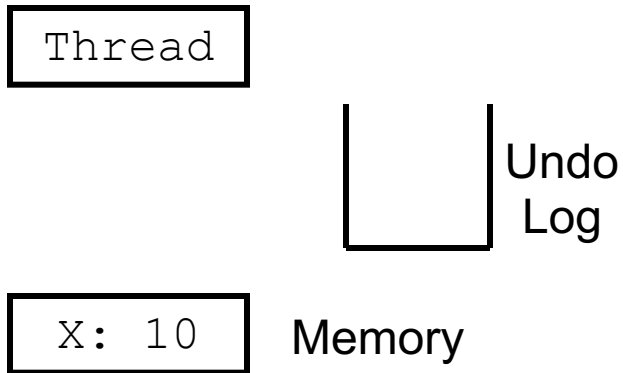

Write X ← 15

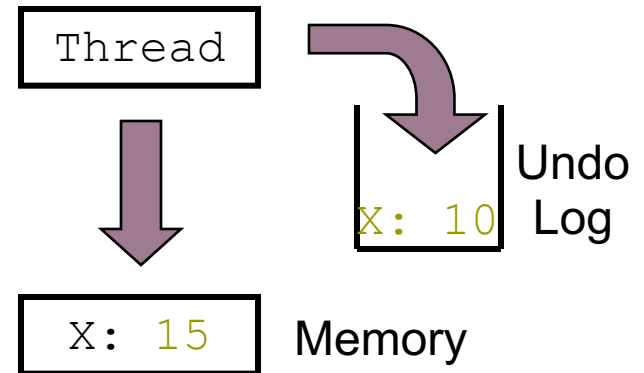

Commit Xaction

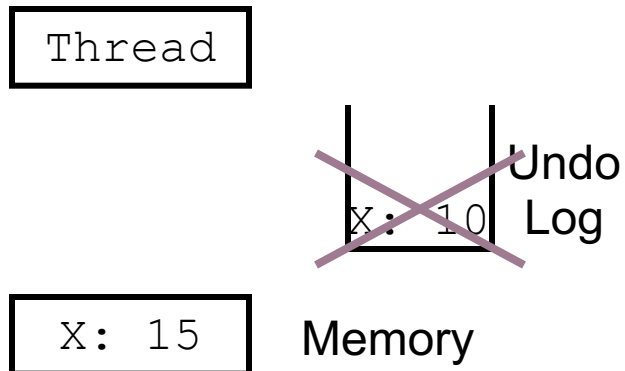

Eager Versioning Illustration

Begin Xaction

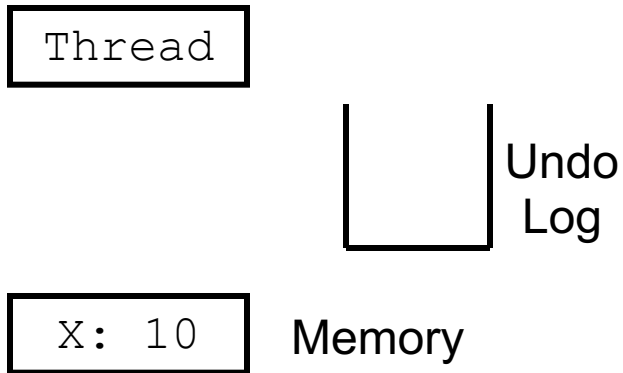

Write X ← 15

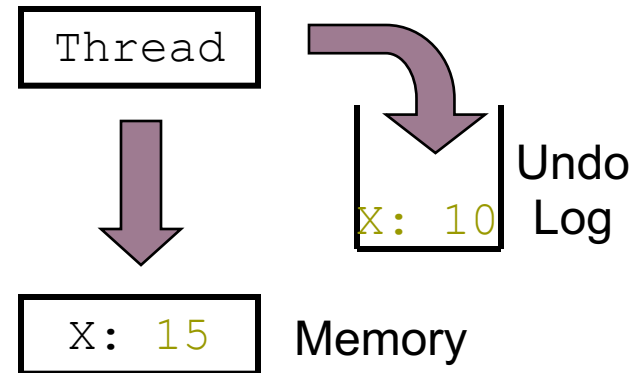

Commit Xaction

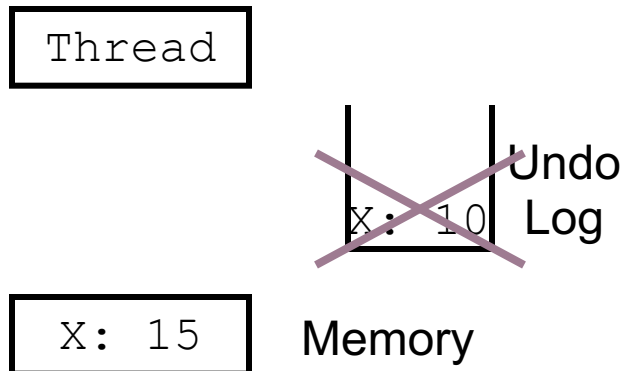

Abort Xaction

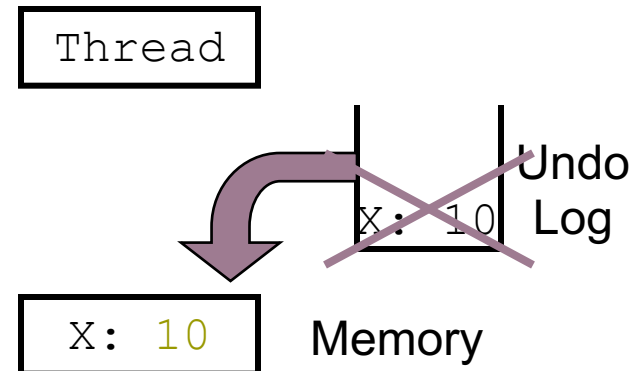

Lazy Versioning Illustration

Begin Xaction

Thread

Write
Buffer

X: 10

Memory

Lazy Versioning Illustration

Begin Xaction

Thread

Write Buffer

X: 10

Memory

Write X ← 15

Thread

x: 15

Write Buffer

X: 10

Memory

Lazy Versioning Illustration

Begin Xaction

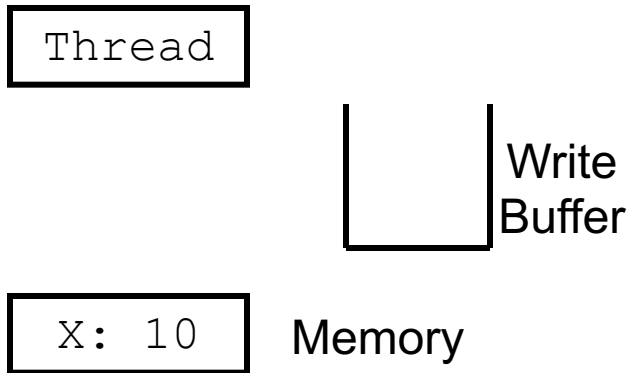

Write X ← 15

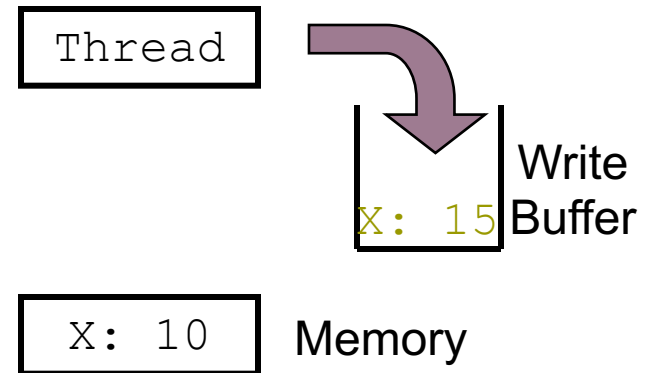

Commit Xaction

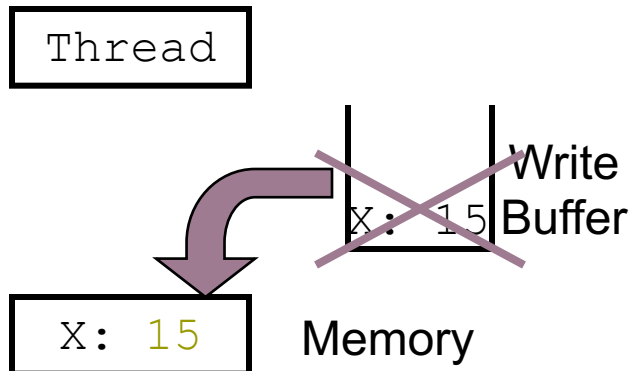

Lazy Versioning Illustration

Begin Xaction

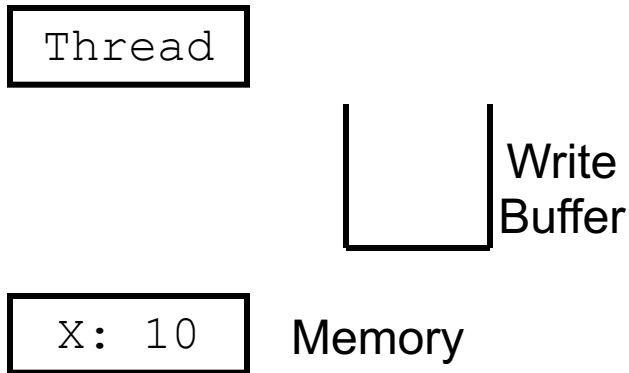

Write X ← 15

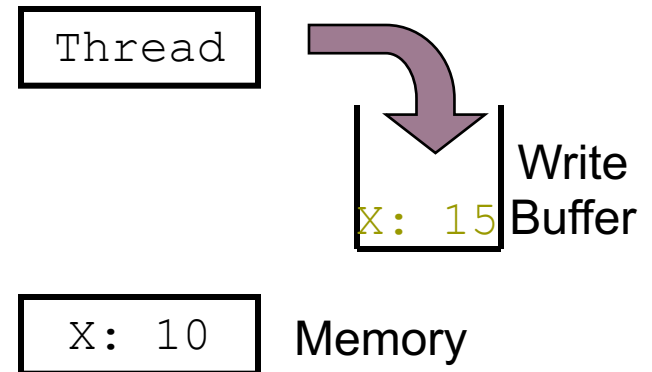

Commit Xaction

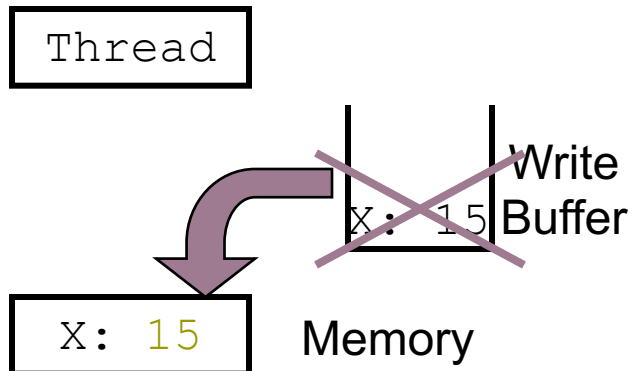

Abort Xaction

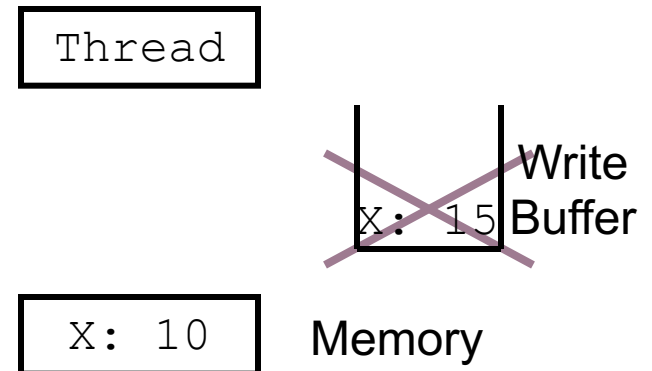

Conflict Detection

- Detect and handle conflicts between transaction
 - Read-Write and (often) Write-Write conflicts
 - Must track the transaction's read-set and write-set
 - Read-set: addresses read within the transaction
 - Write-set: addresses written within transaction

Conflict Detection

- Detect and handle conflicts between transaction
 - Read-Write and (often) Write-Write conflicts
 - Must track the transaction's read-set and write-set
 - Read-set: addresses read within the transaction
 - Write-set: addresses written within transaction

1. Pessimistic detection

- Check for conflicts during loads or stores
 - SW: SW barriers using locks and/or version numbers
 - HW: check through coherence actions
- Use contention manager to decide to stall or abort
 - Various priority policies to handle common case fast

Pessimistic Detection Illustration

Case 1

TIME
↓

Success

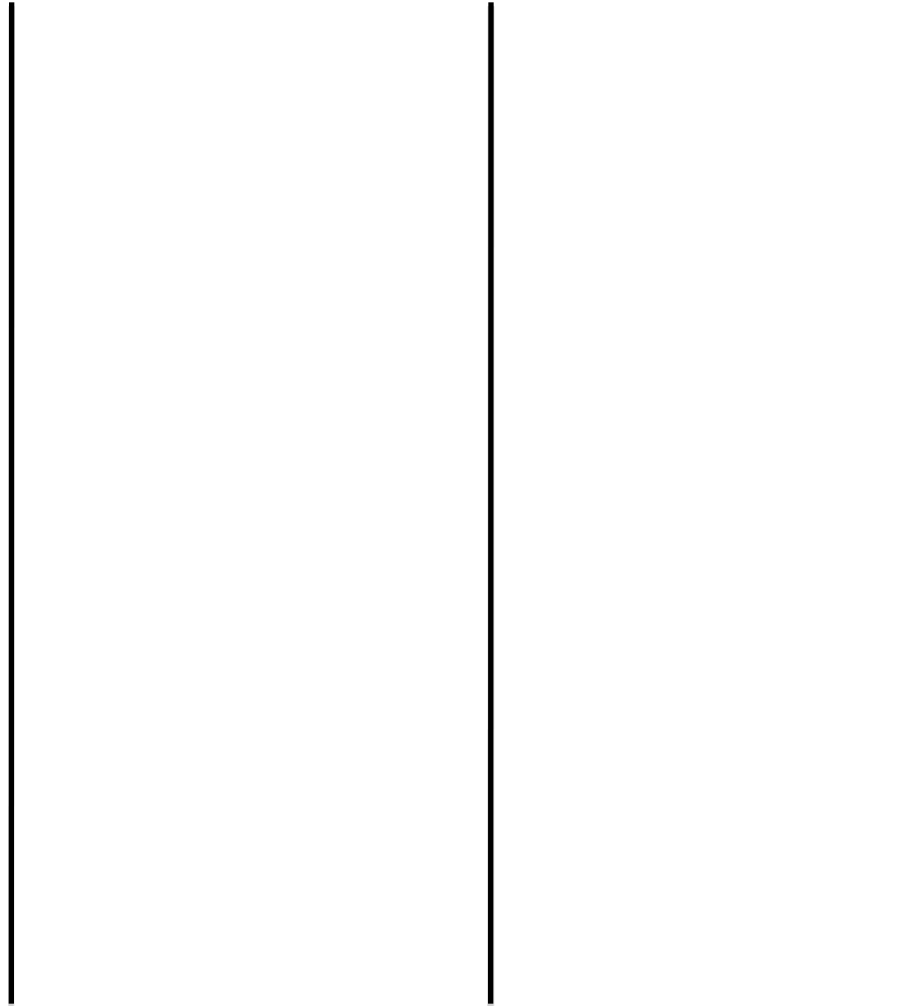

Pessimistic Detection Illustration

Case 1

X0

X1

TIME
↓

Success

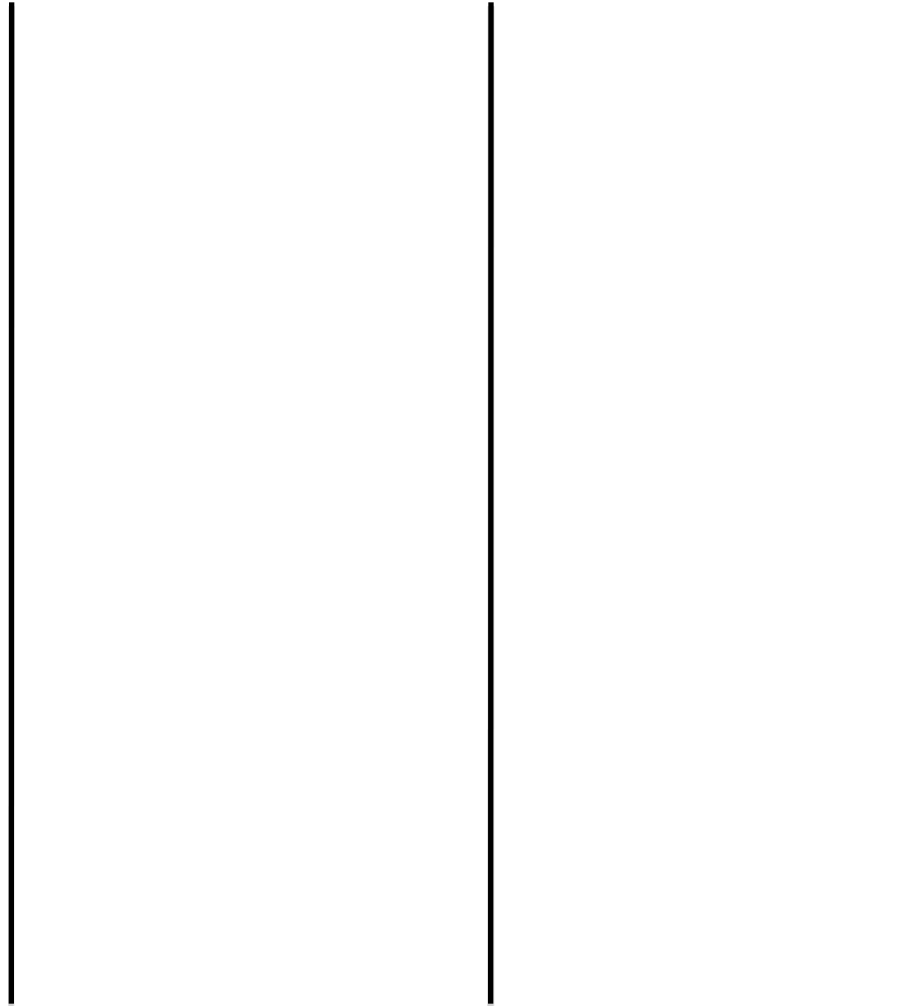

Pessimistic Detection Illustration

Case 1

X0



X1



Success

TIME
↓



Pessimistic Detection Illustration

Case 1

X0

X1



rd A



TIME
↓

Success

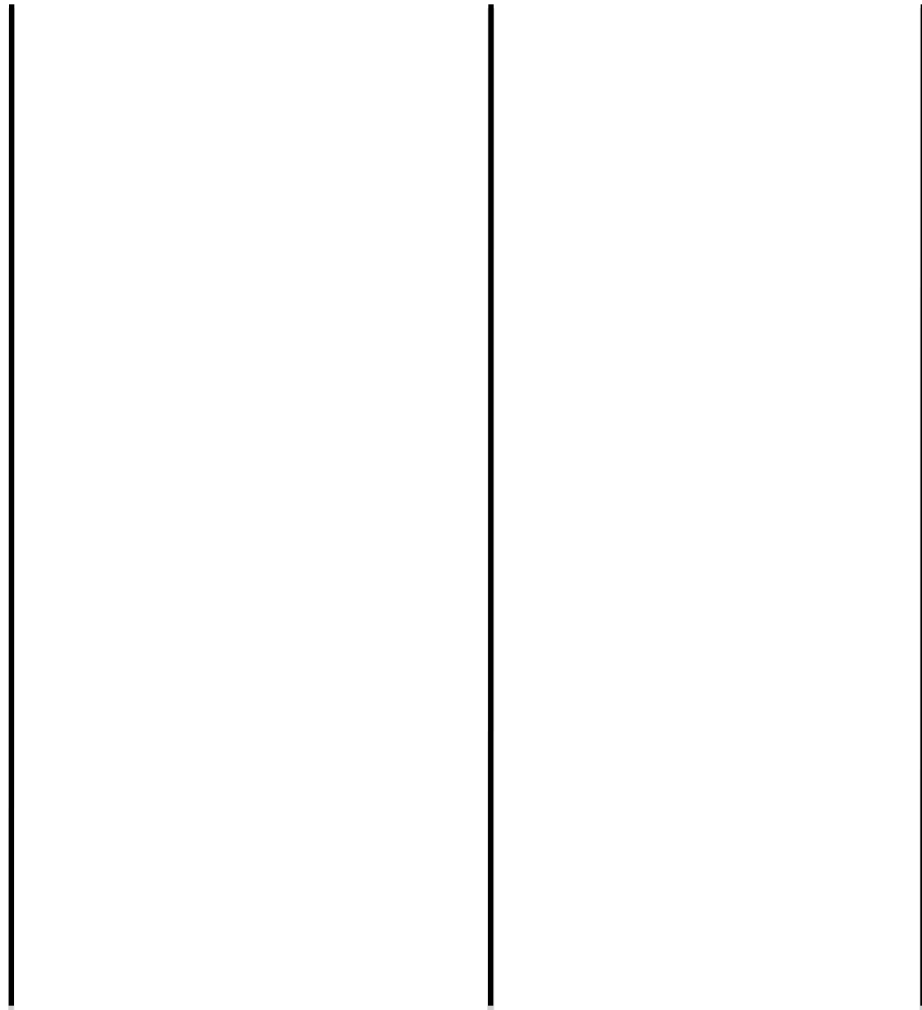

Pessimistic Detection Illustration

Case 1

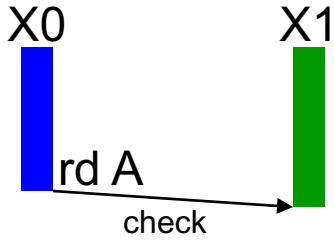

Success

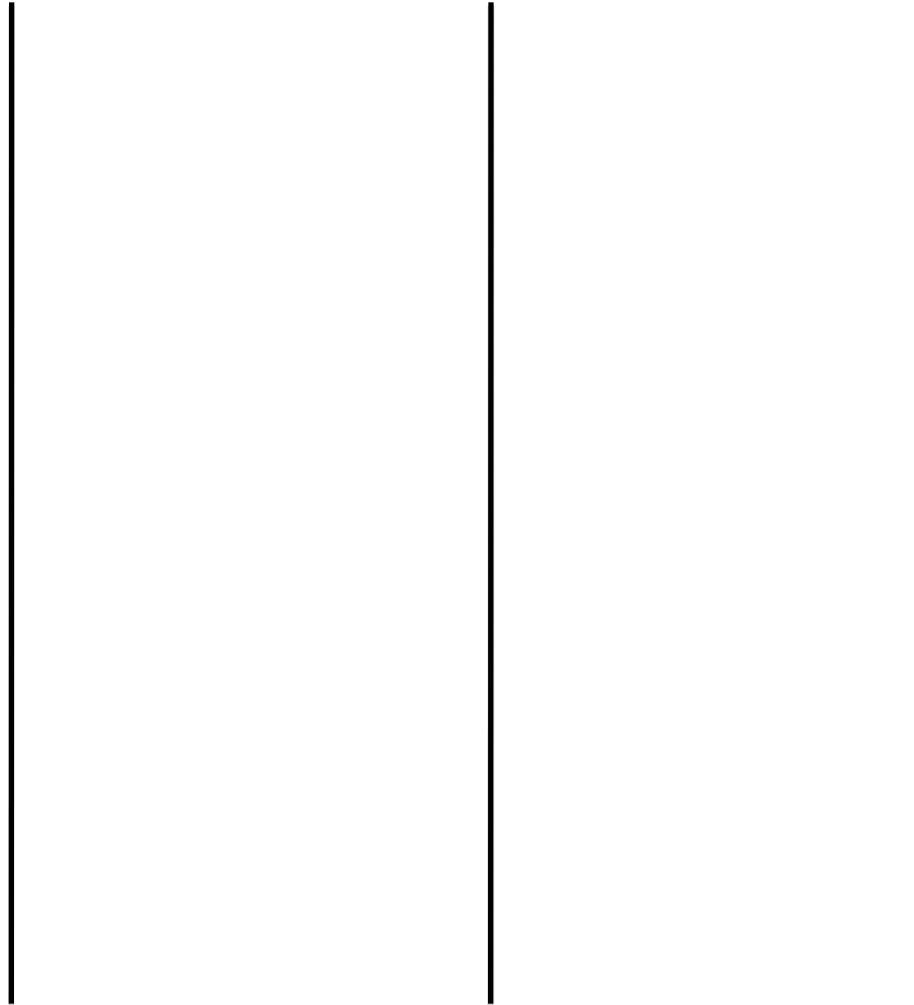

Pessimistic Detection Illustration

Case 1

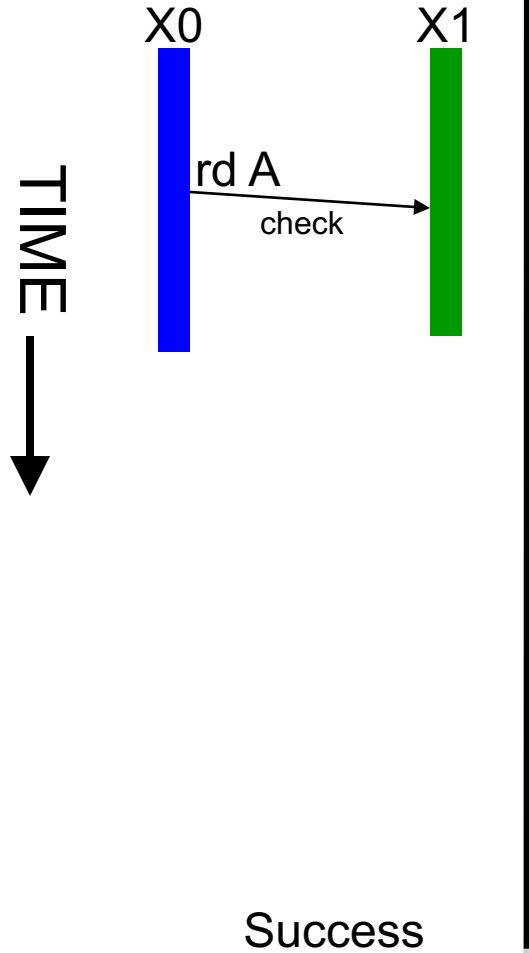

Pessimistic Detection Illustration

Case 1

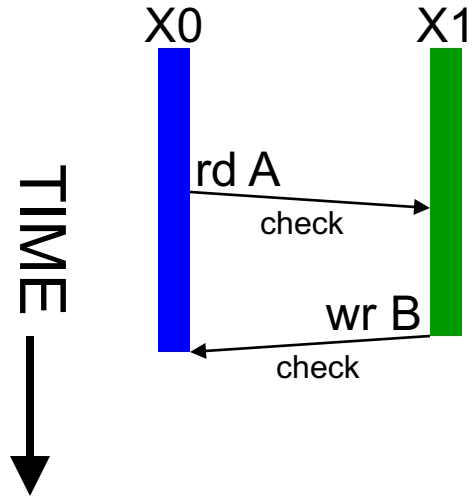

Success

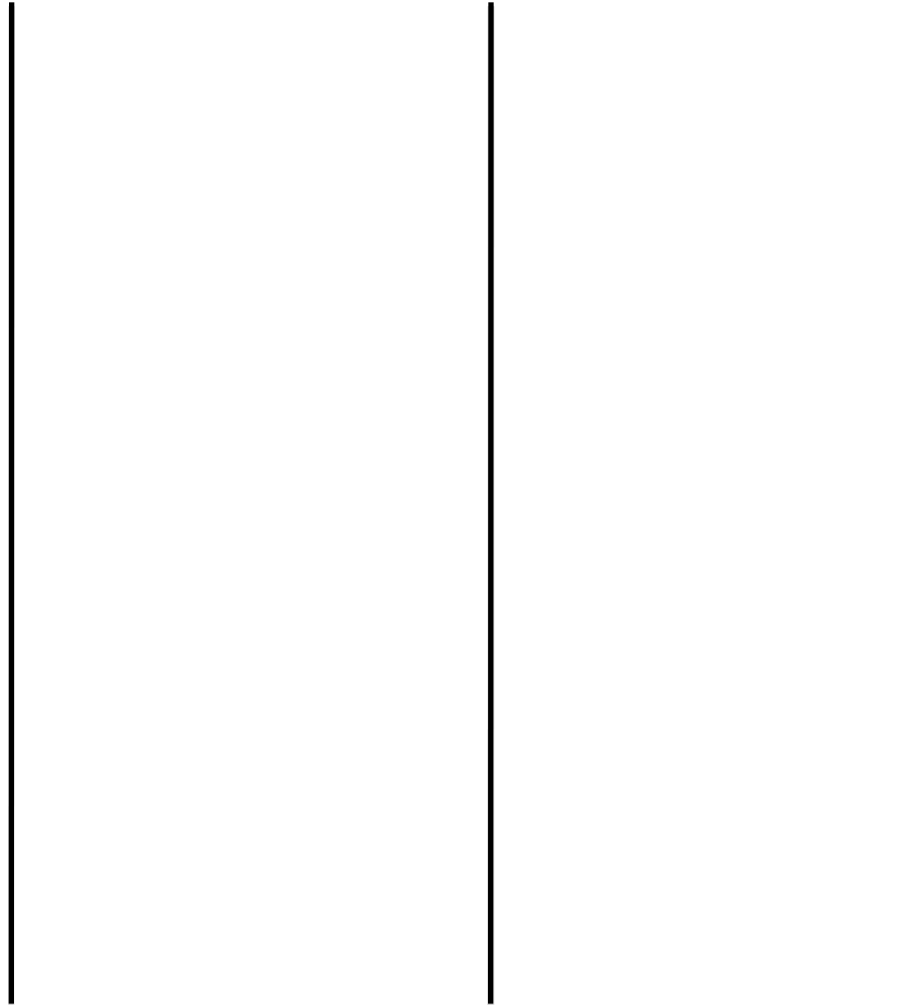

Pessimistic Detection Illustration

Case 1

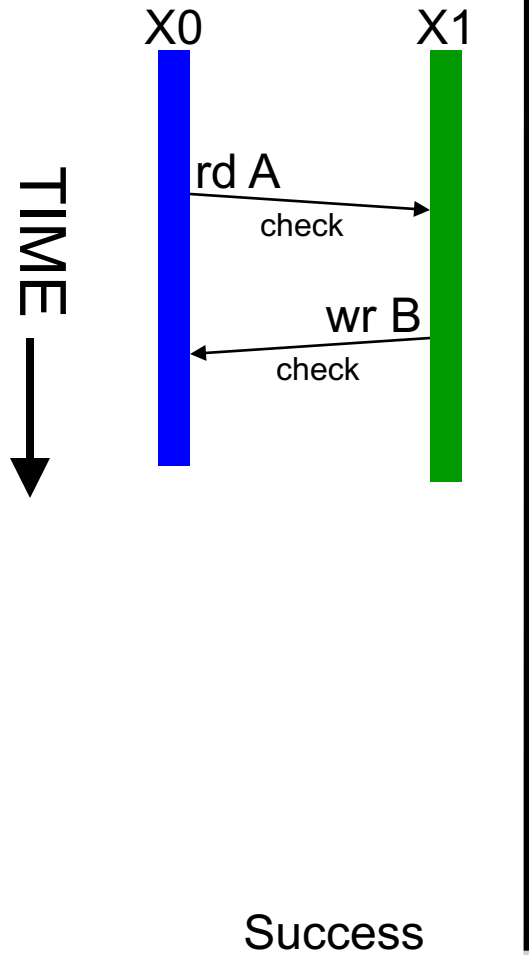

Pessimistic Detection Illustration

Case 1

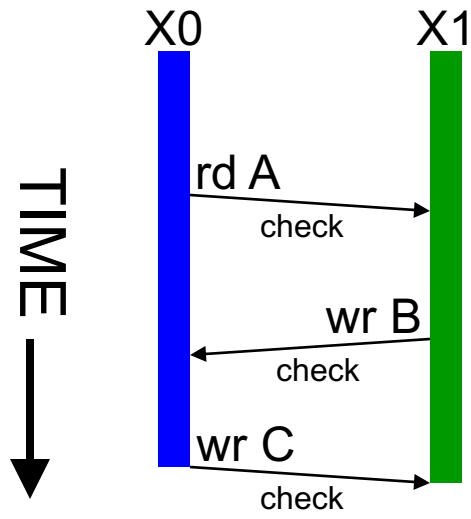

Success

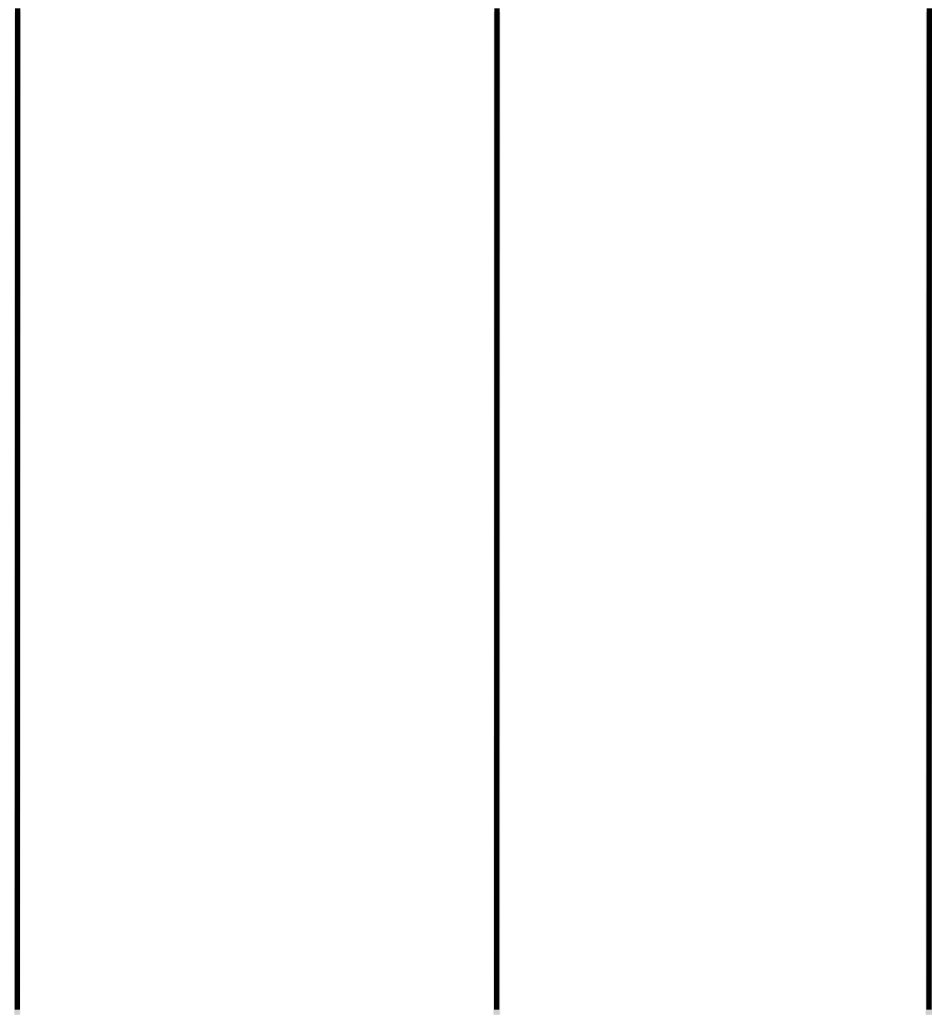

Pessimistic Detection Illustration

Case 1

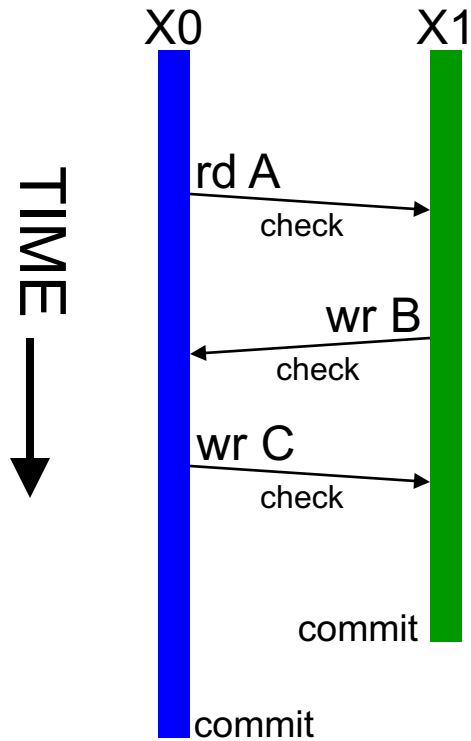

Success

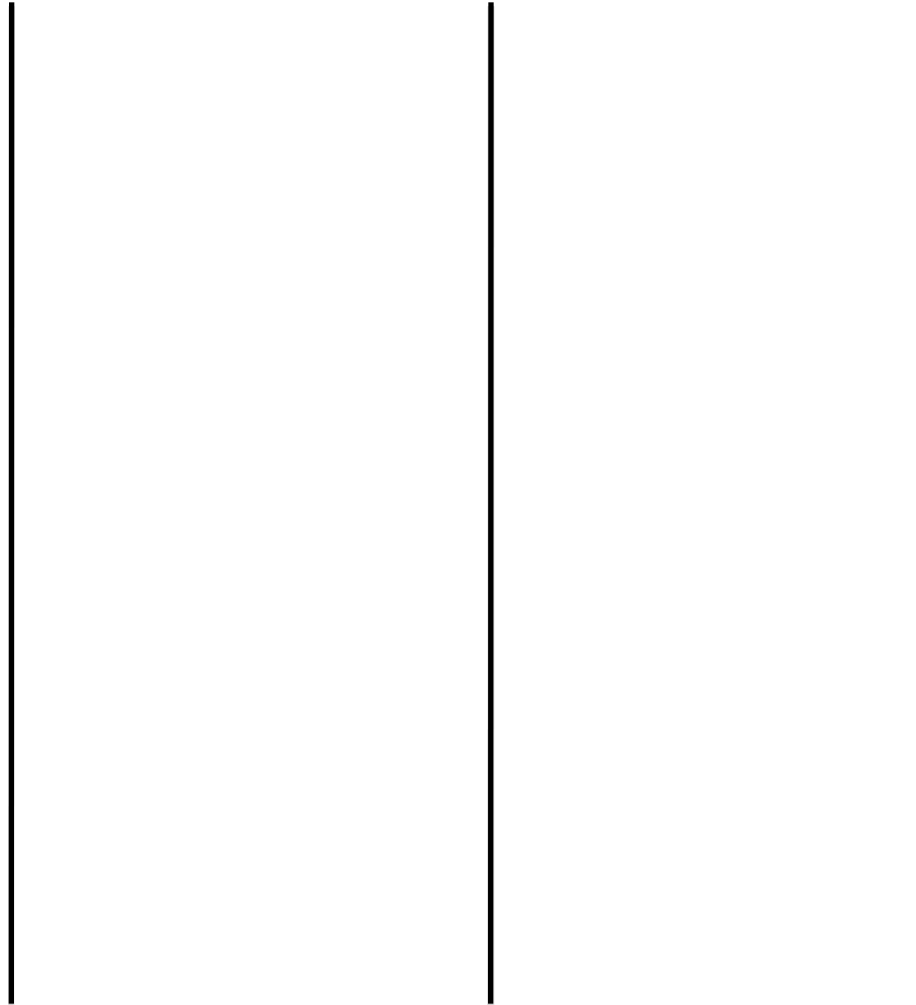

Pessimistic Detection Illustration

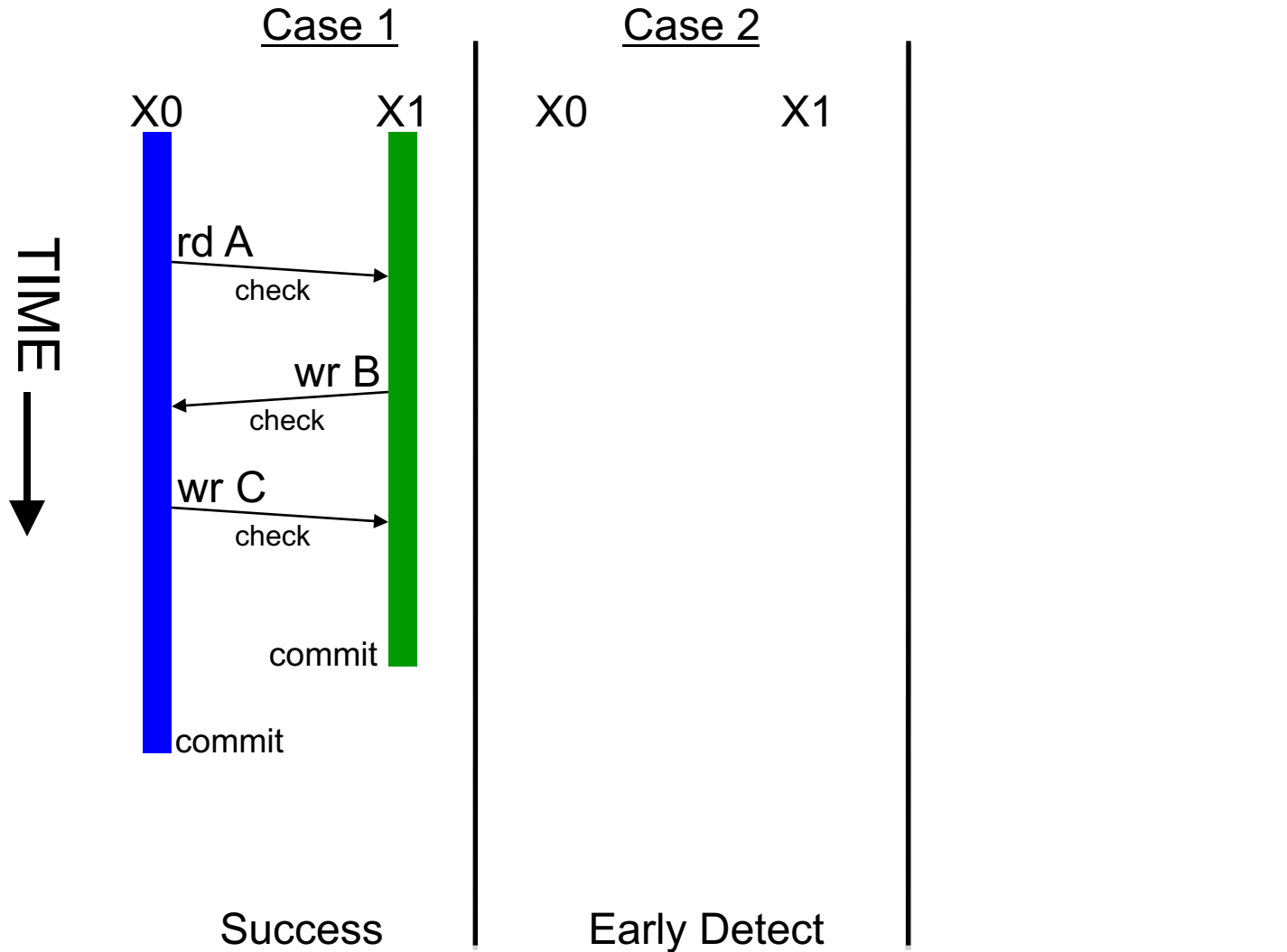

Pessimistic Detection Illustration

Case 1

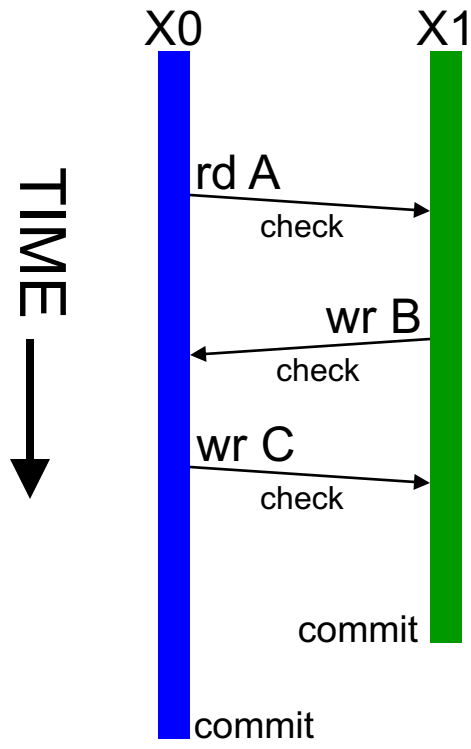

Success

Case 2

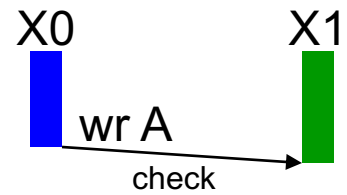

Early Detect

Pessimistic Detection Illustration

Case 1

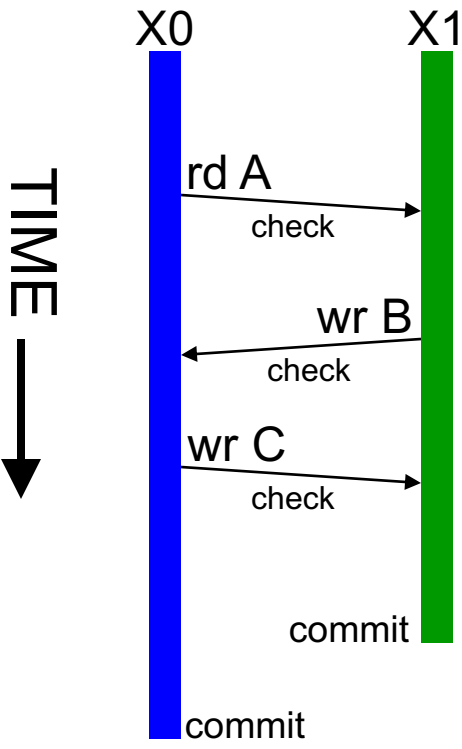

Success

Case 2

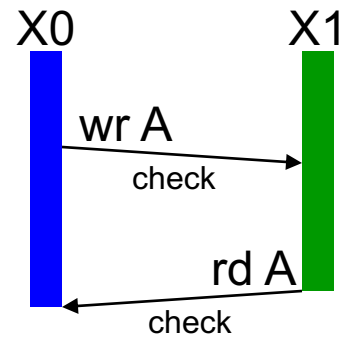

Early Detect

Pessimistic Detection Illustration

Case 1

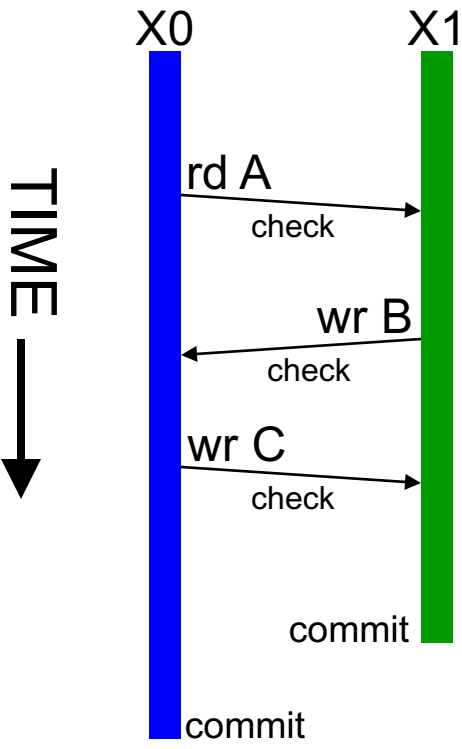

Success

Case 2

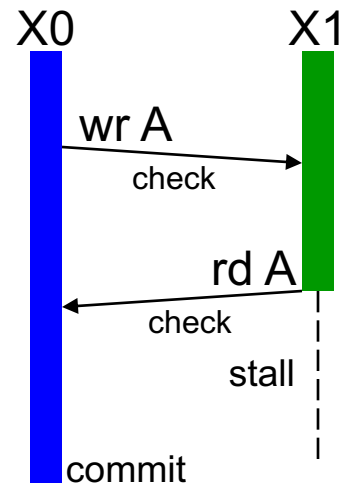

Early Detect

Pessimistic Detection Illustration

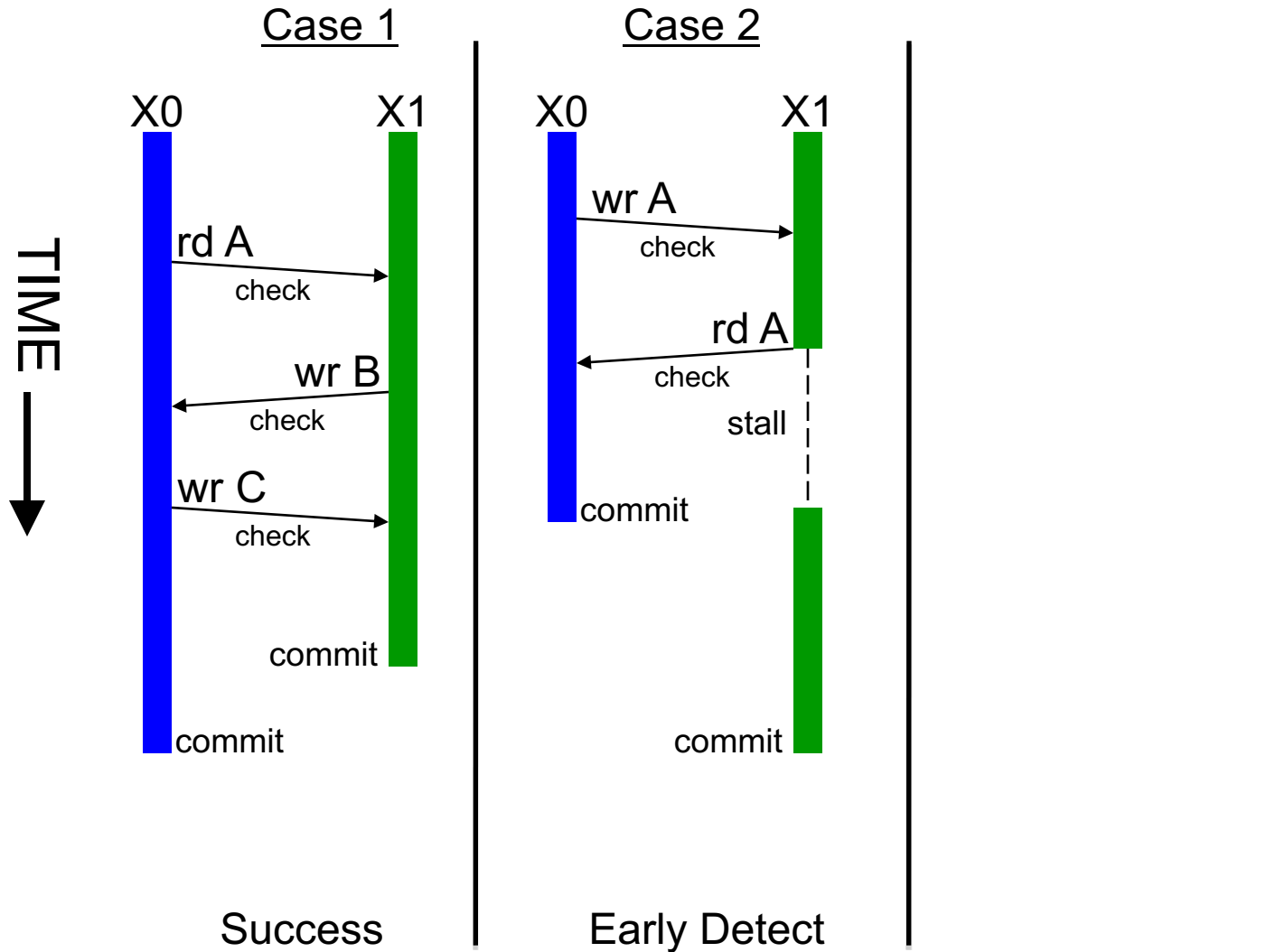

Pessimistic Detection Illustration

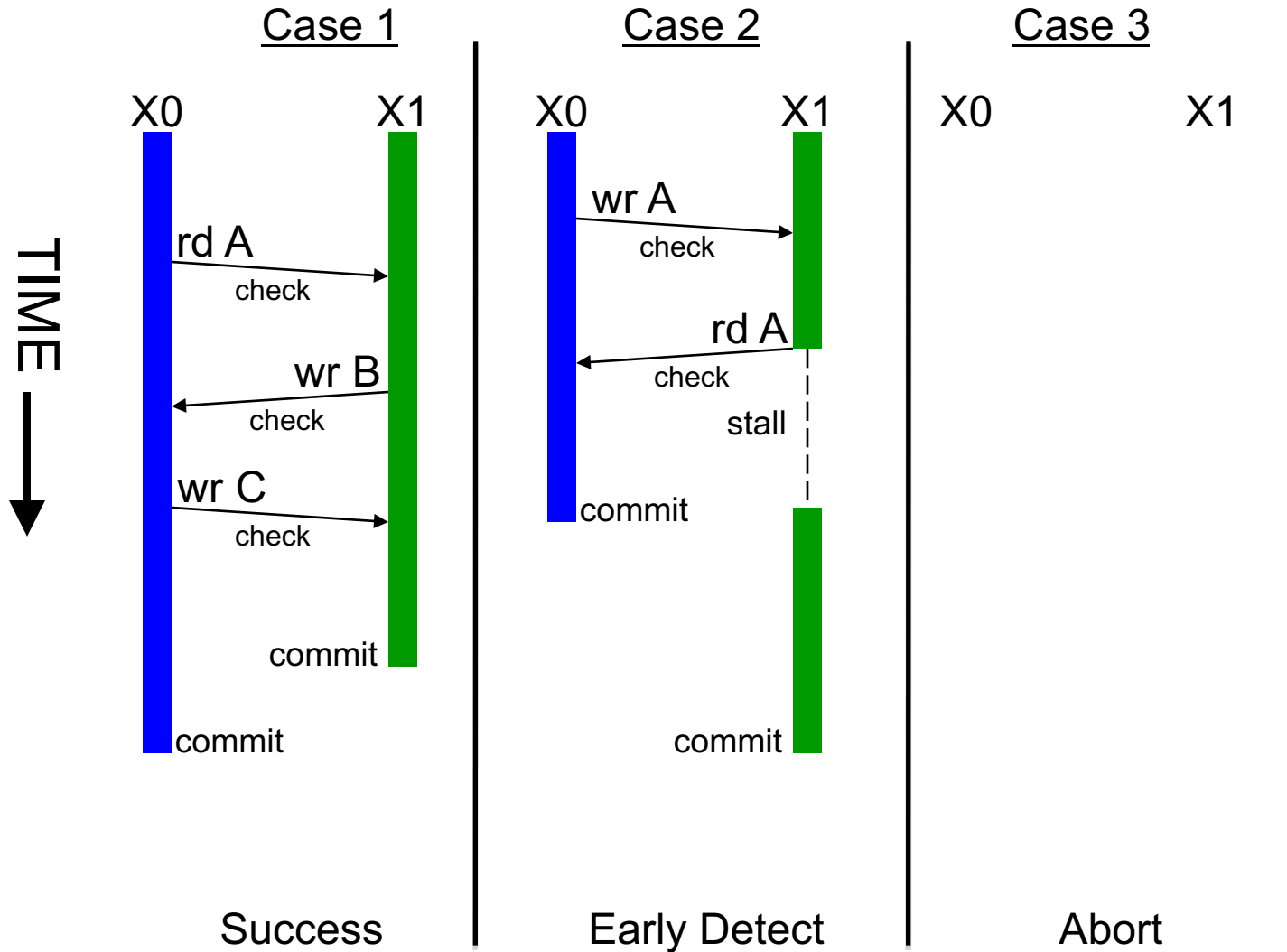

Pessimistic Detection Illustration

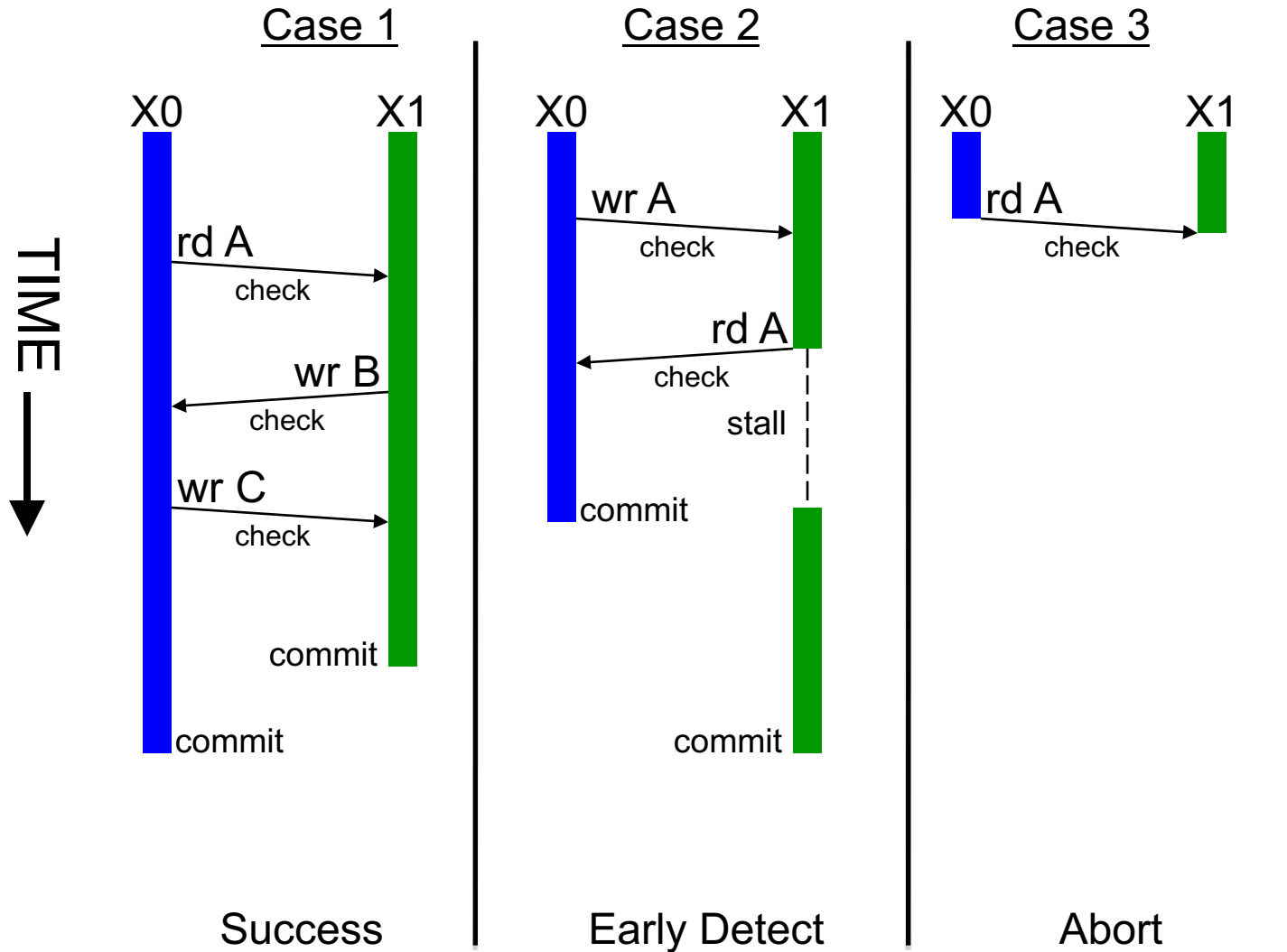

Pessimistic Detection Illustration

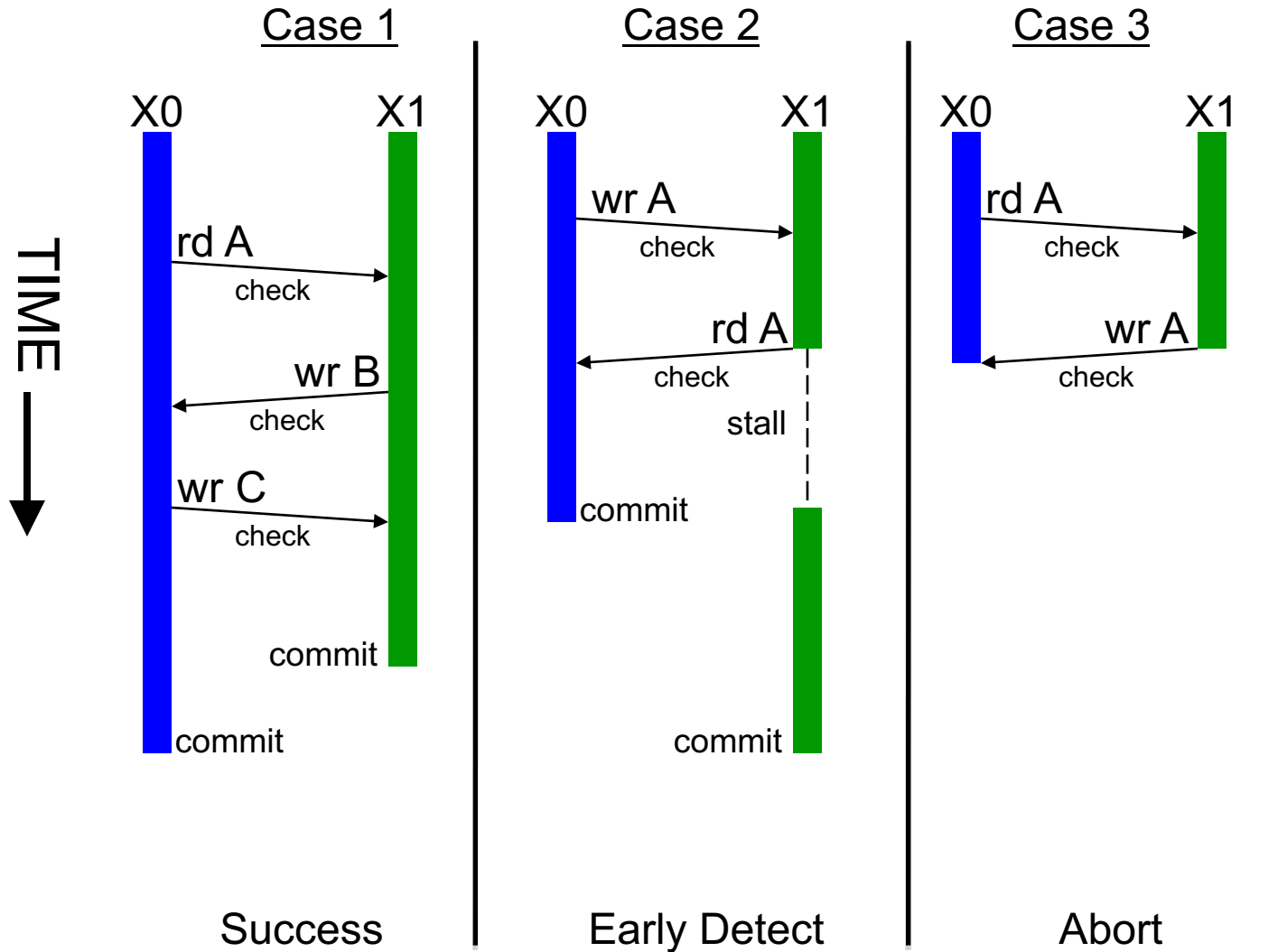

Pessimistic Detection Illustration

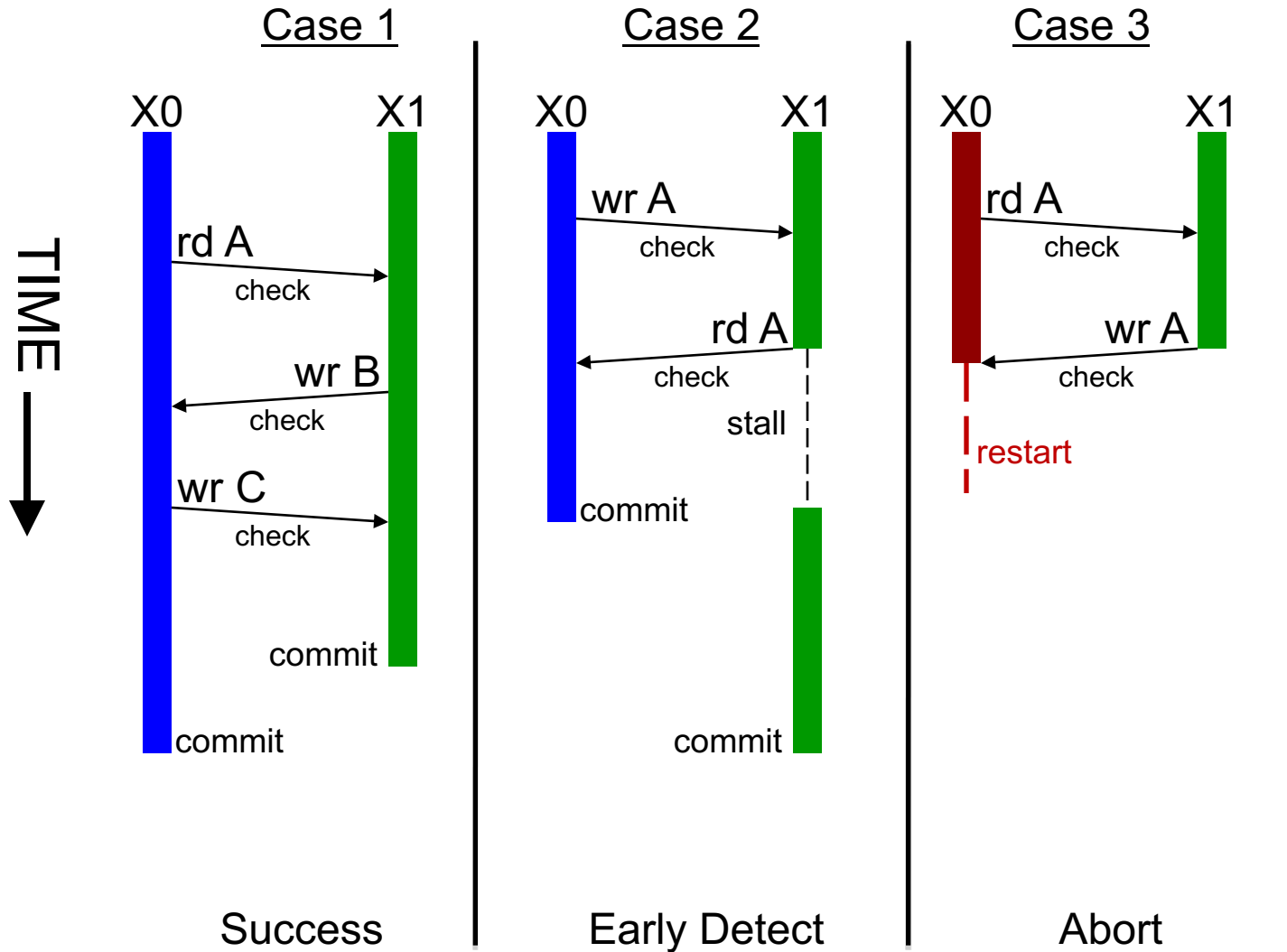

Pessimistic Detection Illustration

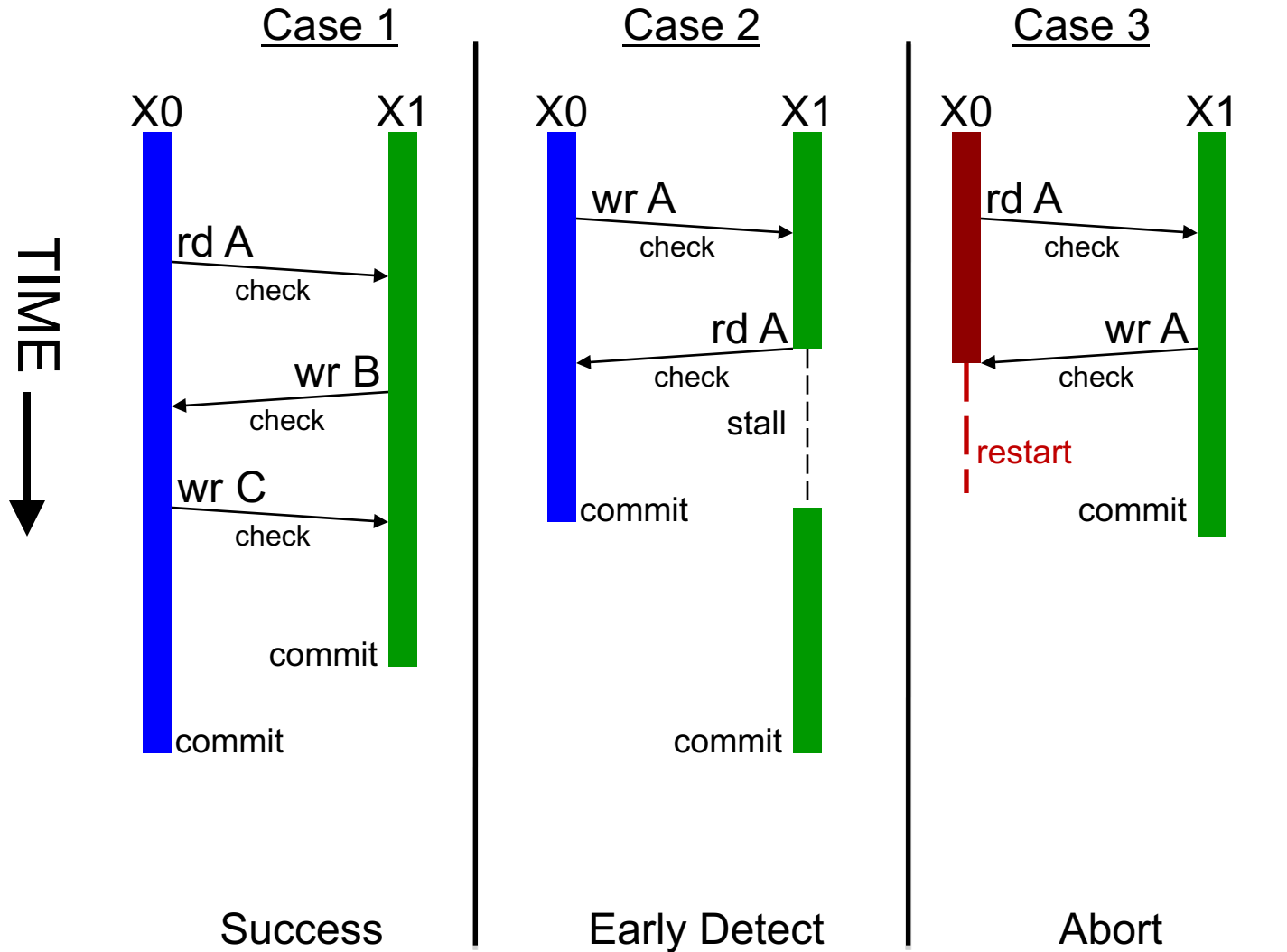

Pessimistic Detection Illustration

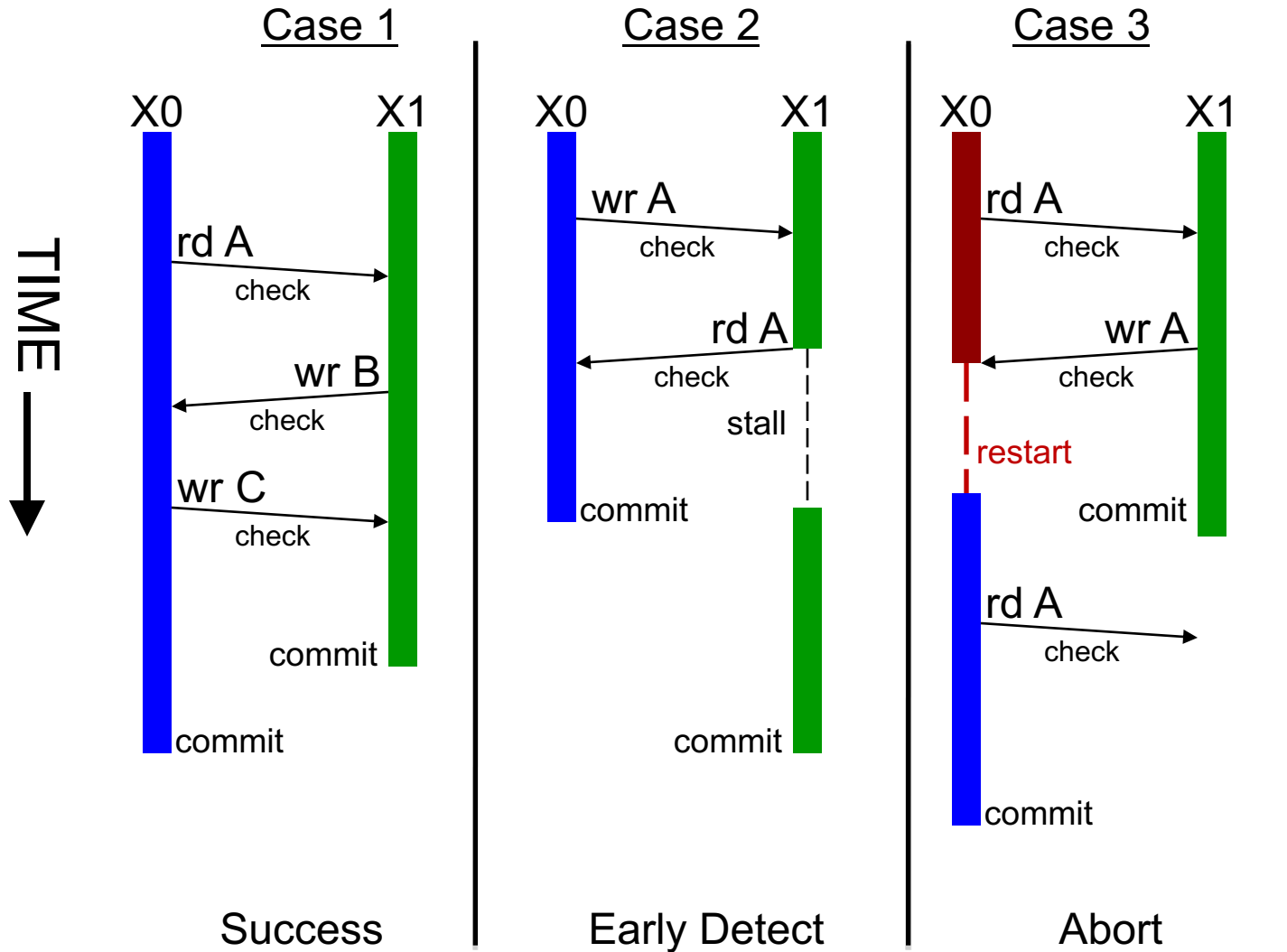

Pessimistic Detection Illustration

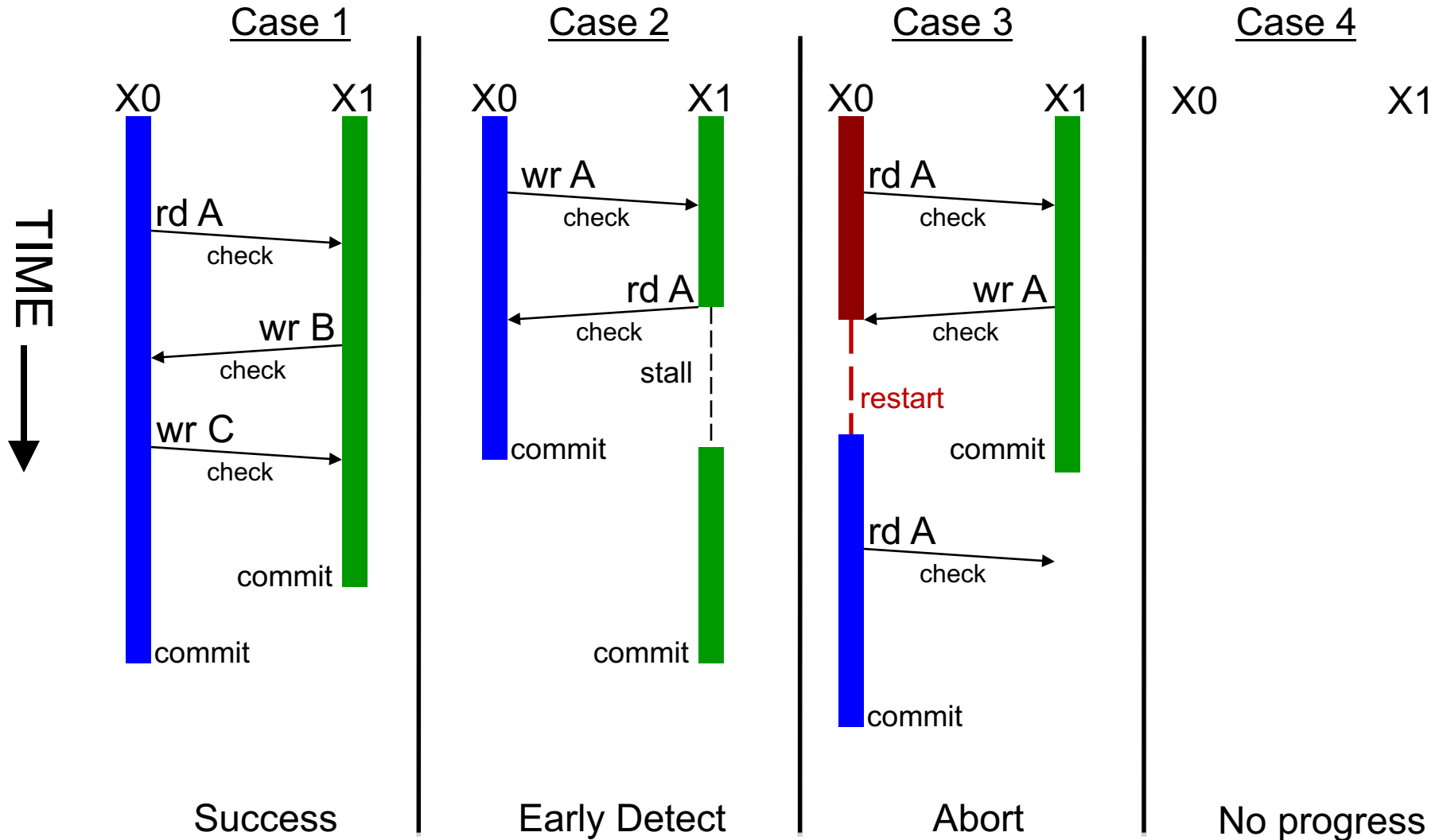

Pessimistic Detection Illustration

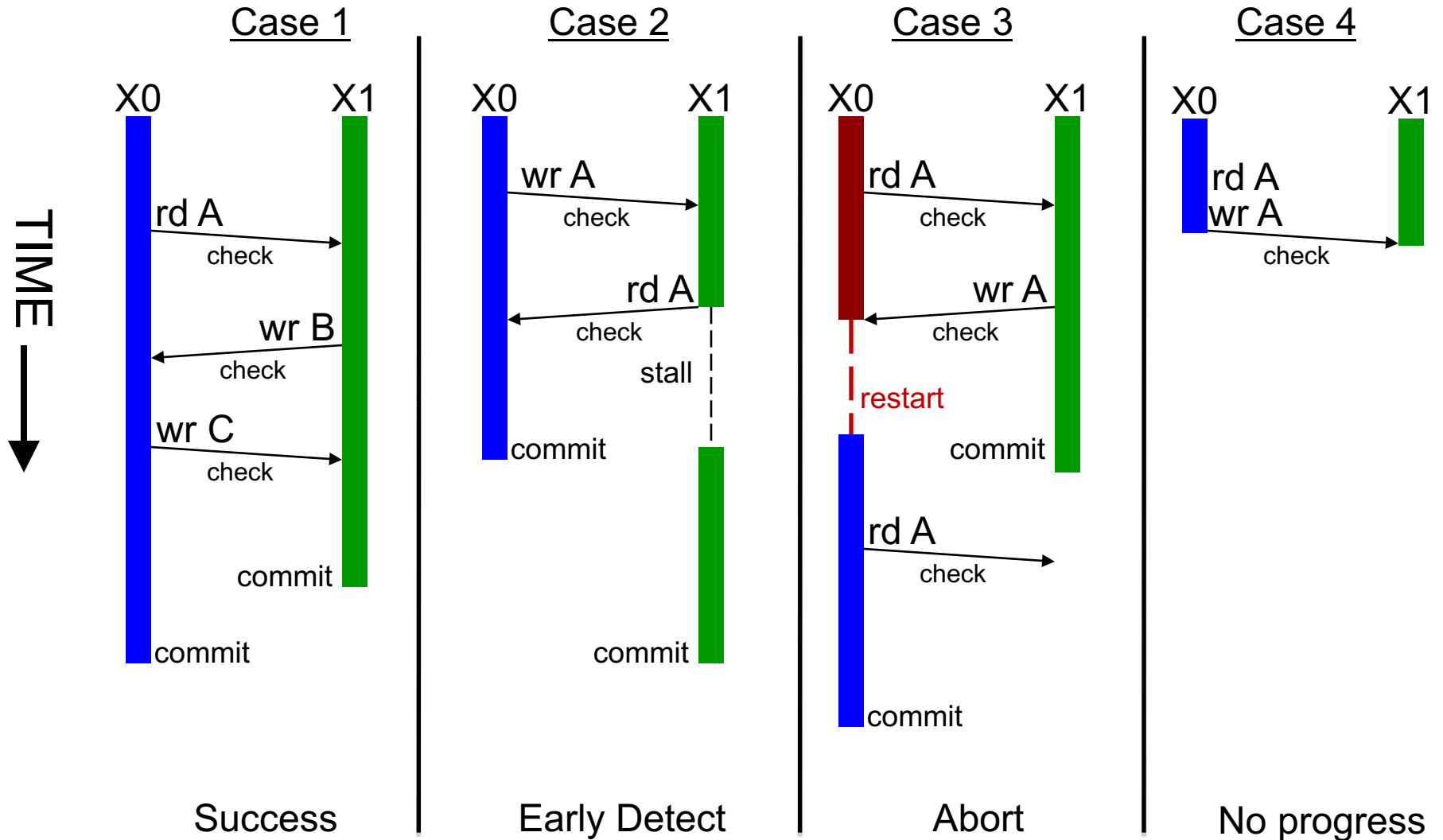

Pessimistic Detection Illustration

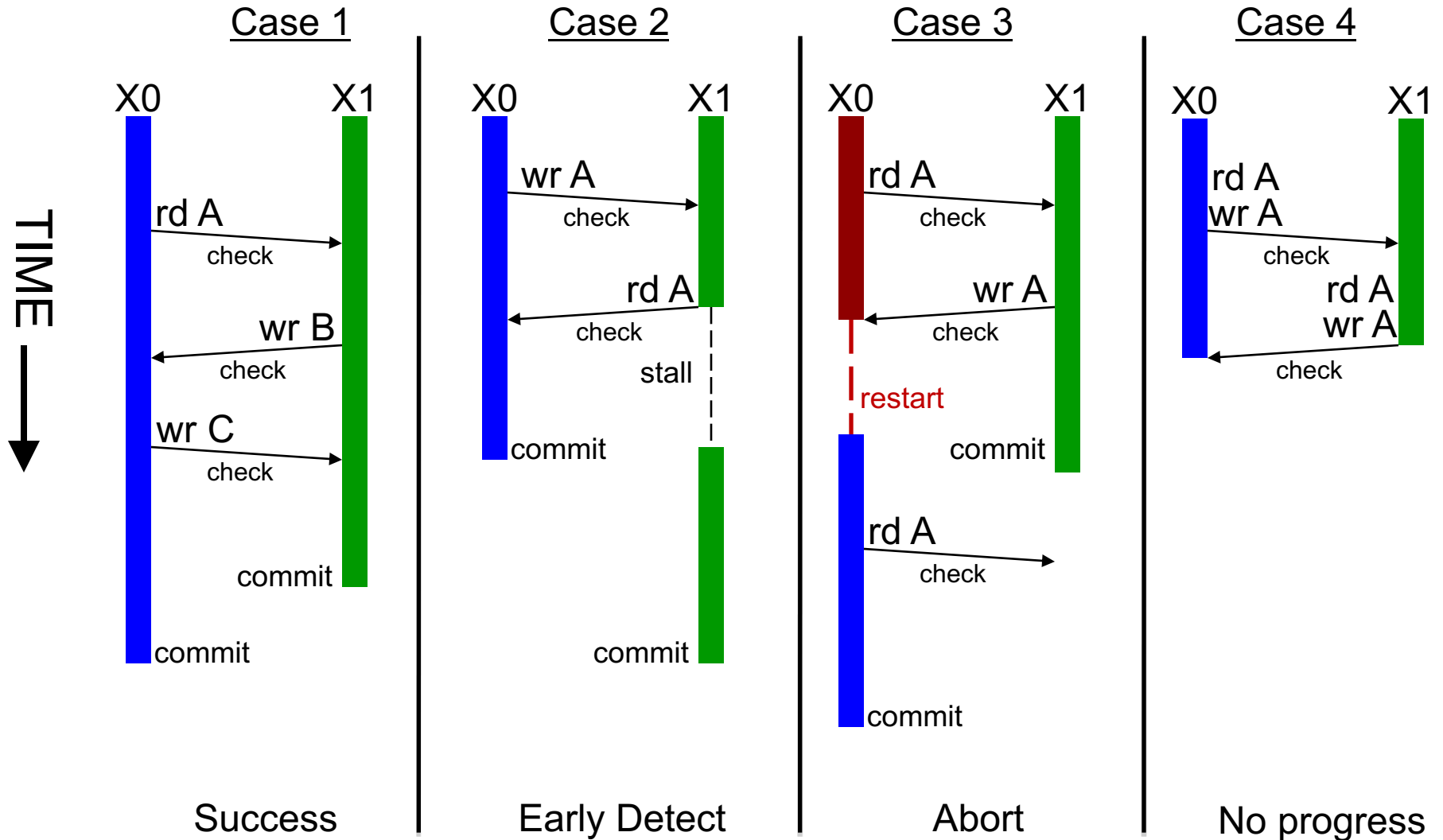

Pessimistic Detection Illustration

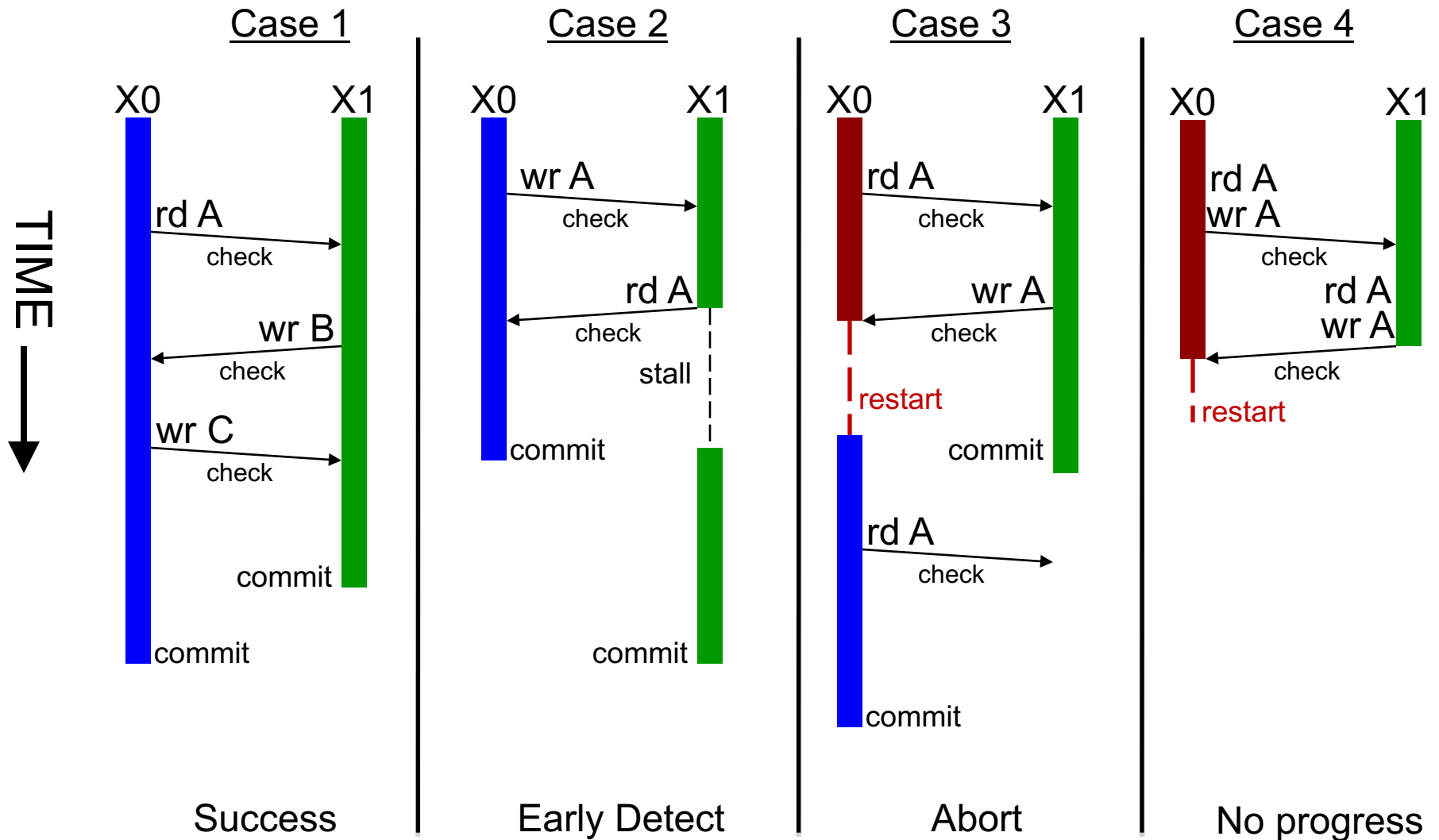

Pessimistic Detection Illustration

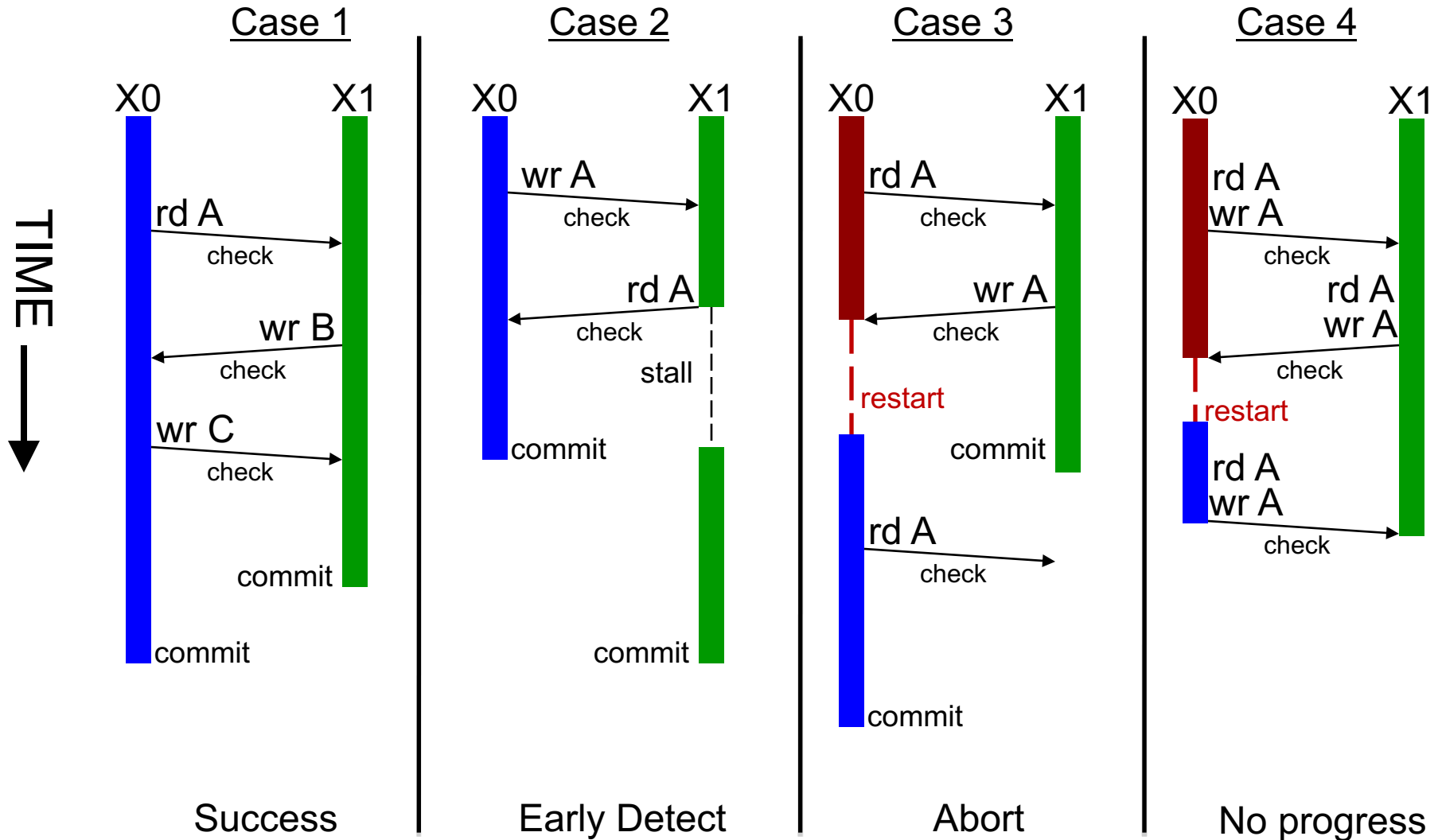

Pessimistic Detection Illustration

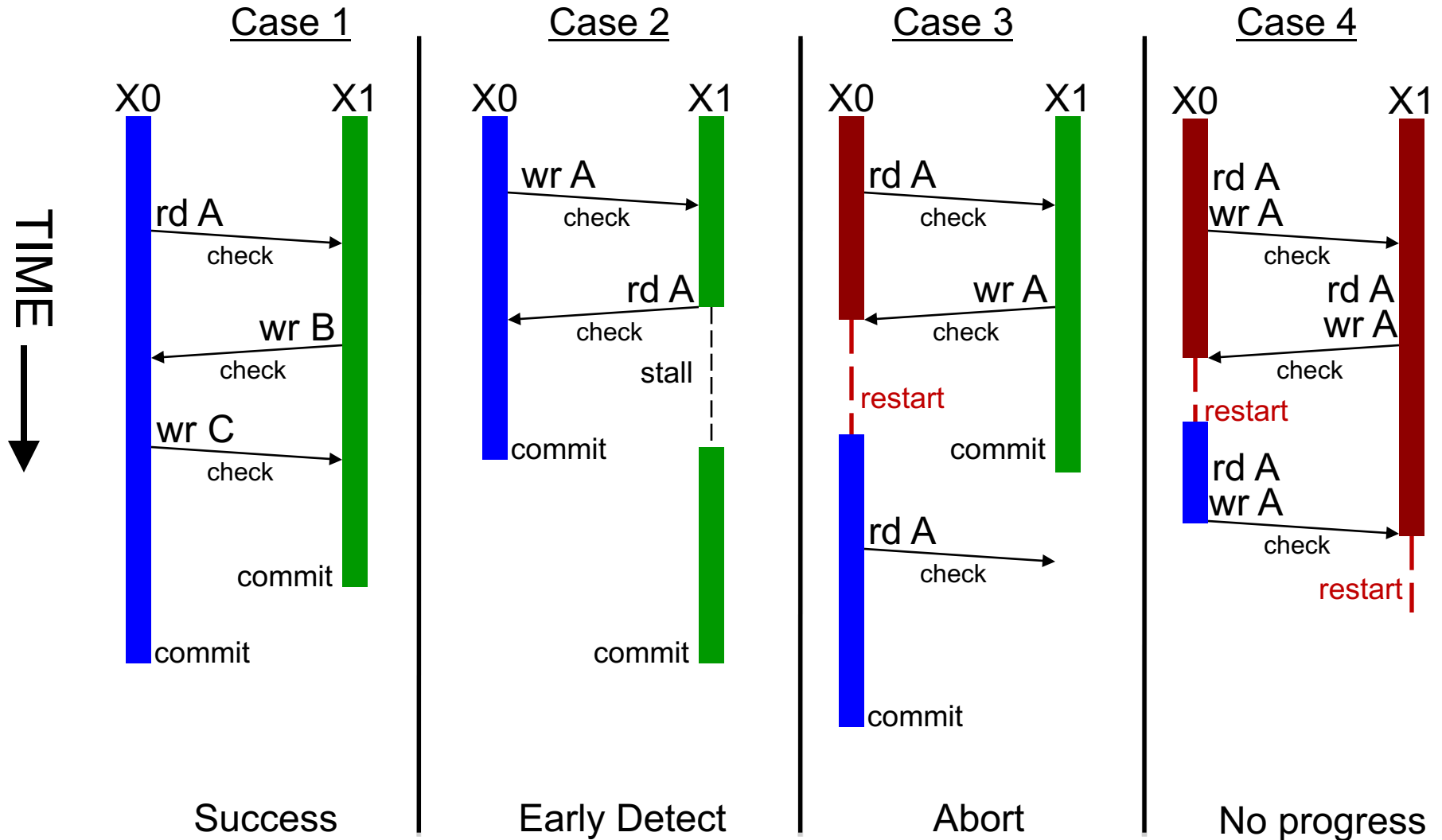

Pessimistic Detection Illustration

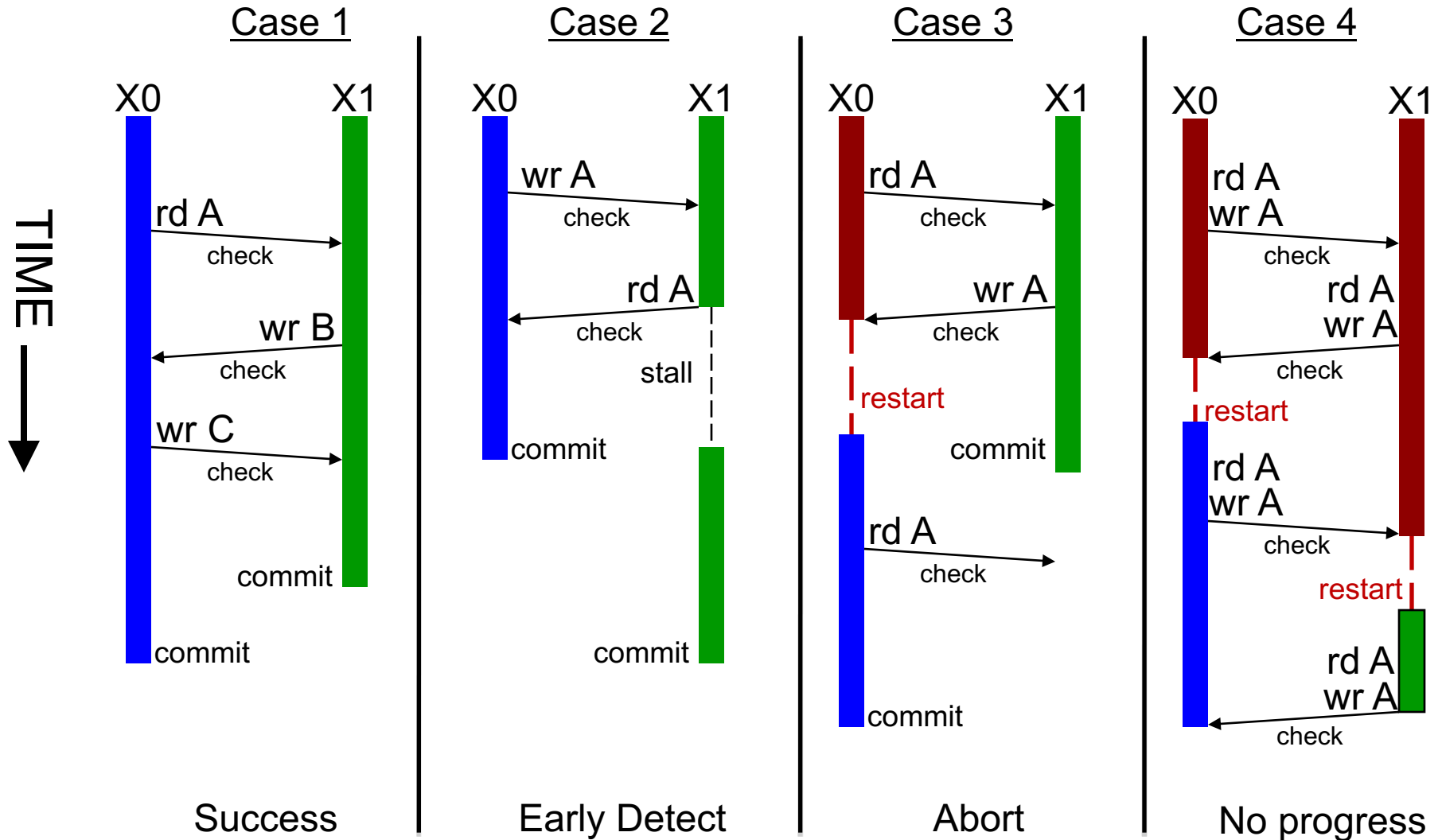

Pessimistic Detection Illustration

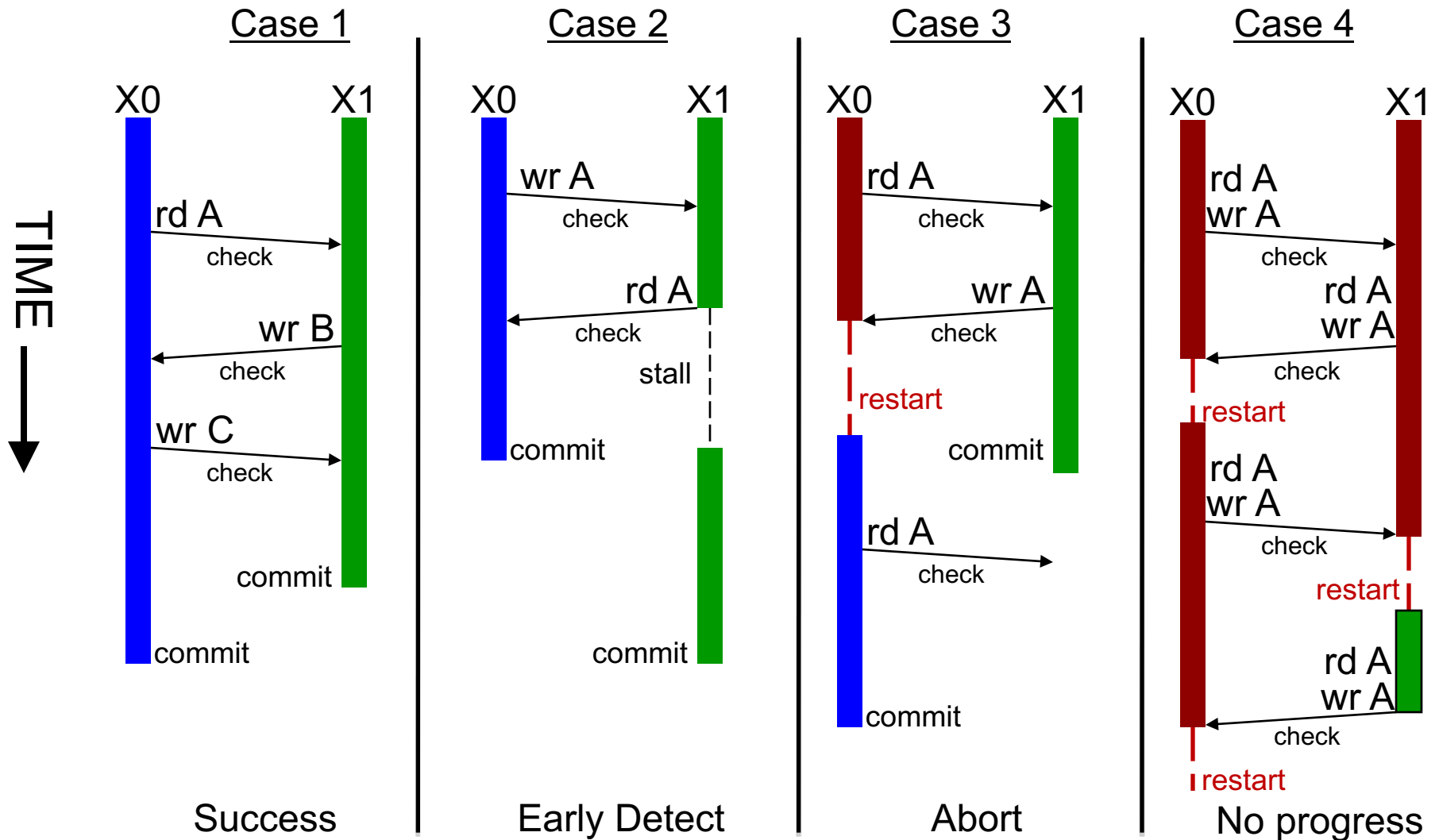

Conflict Detection (cont.)

2. Optimistic detection

- Detect conflicts when a transaction attempts to commit
 - SW: validate write/read-set using locks or version numbers
 - HW: validate write-set using coherence actions
 - Get exclusive access for cache lines in write-set
 - On a conflict, give priority to committing transaction
 - Other transactions may abort later on
 - On conflicts between committing transactions, use contention manager to decide priority
-
- **Note: optimistic & pessimistic schemes together**
 - Several STM systems are optimistic on reads, pessimistic on writes

Optimistic Detection Illustration

TIME
↓

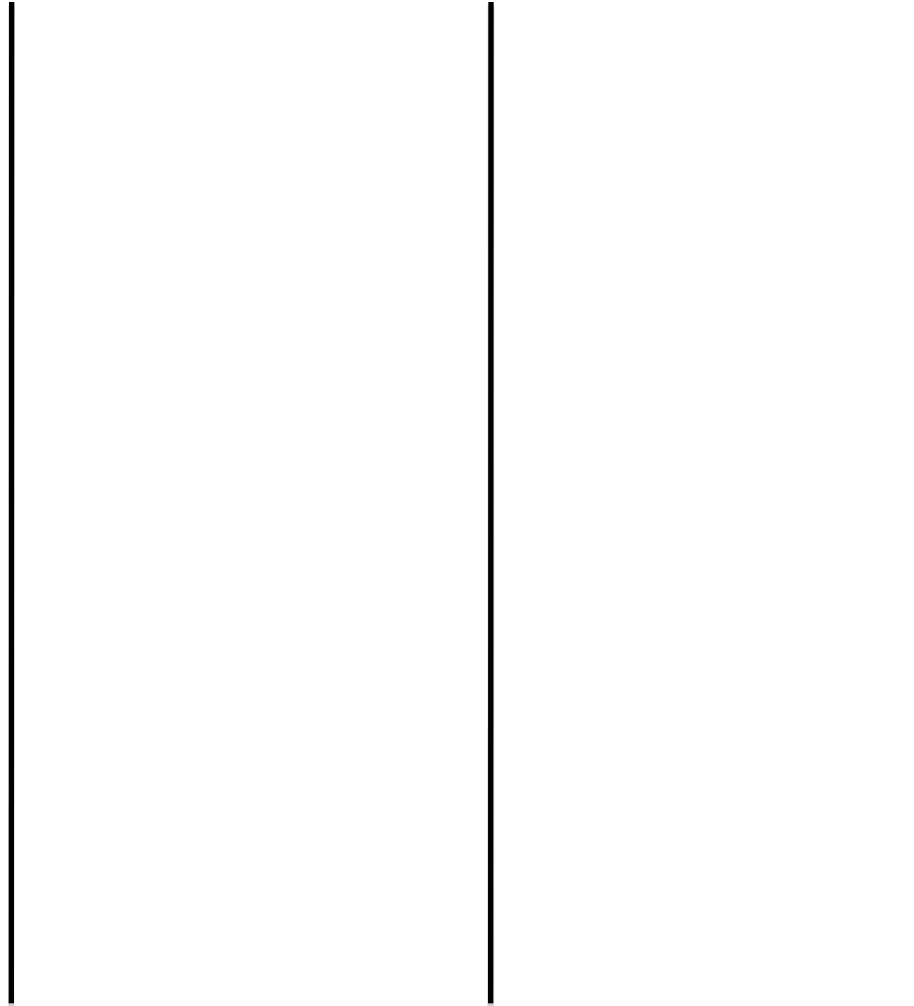

Optimistic Detection Illustration

Case 1

X0

X1

TIME
↓

Success

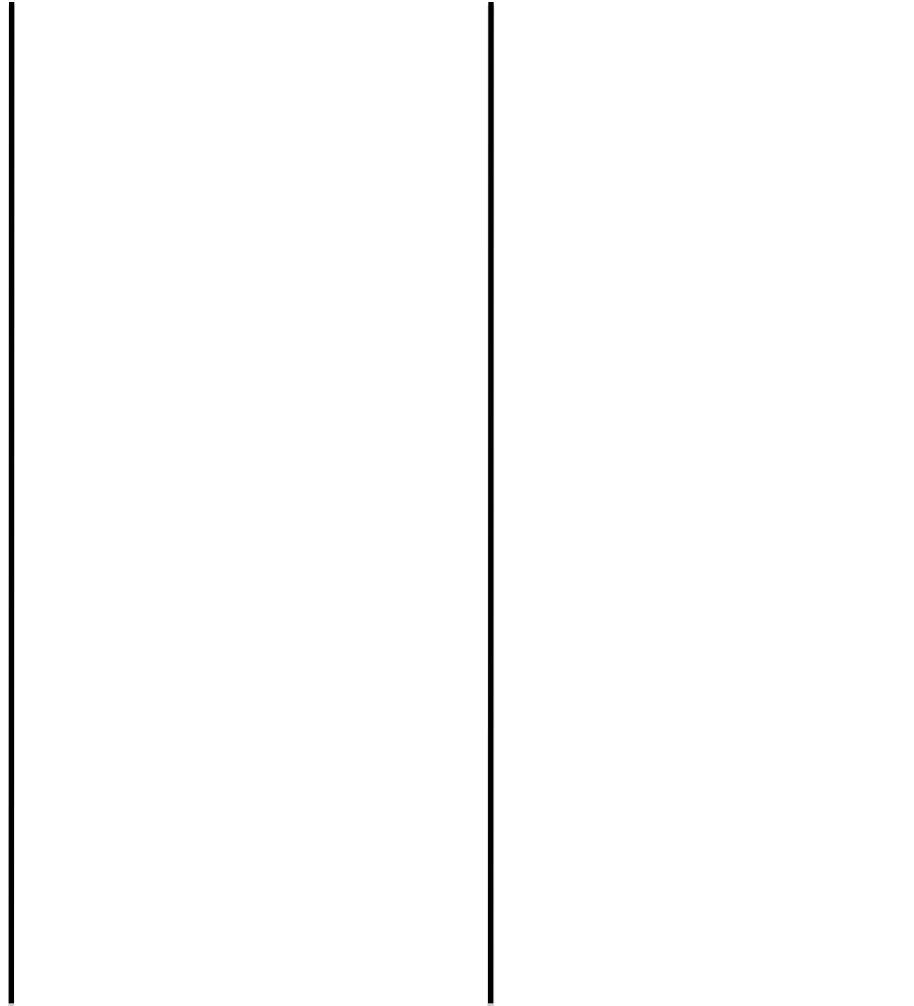

Optimistic Detection Illustration

Case 1

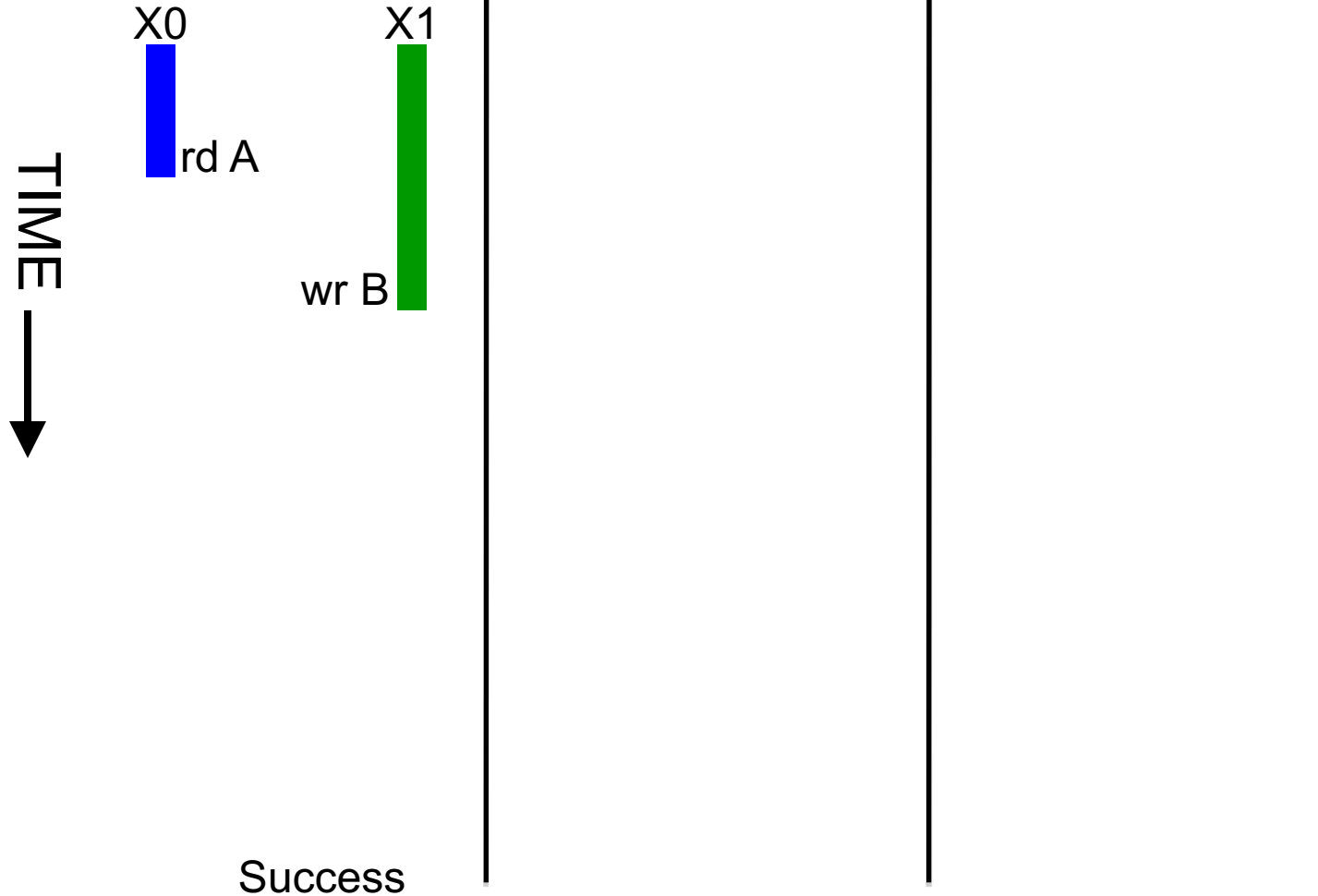

Optimistic Detection Illustration

Case 1

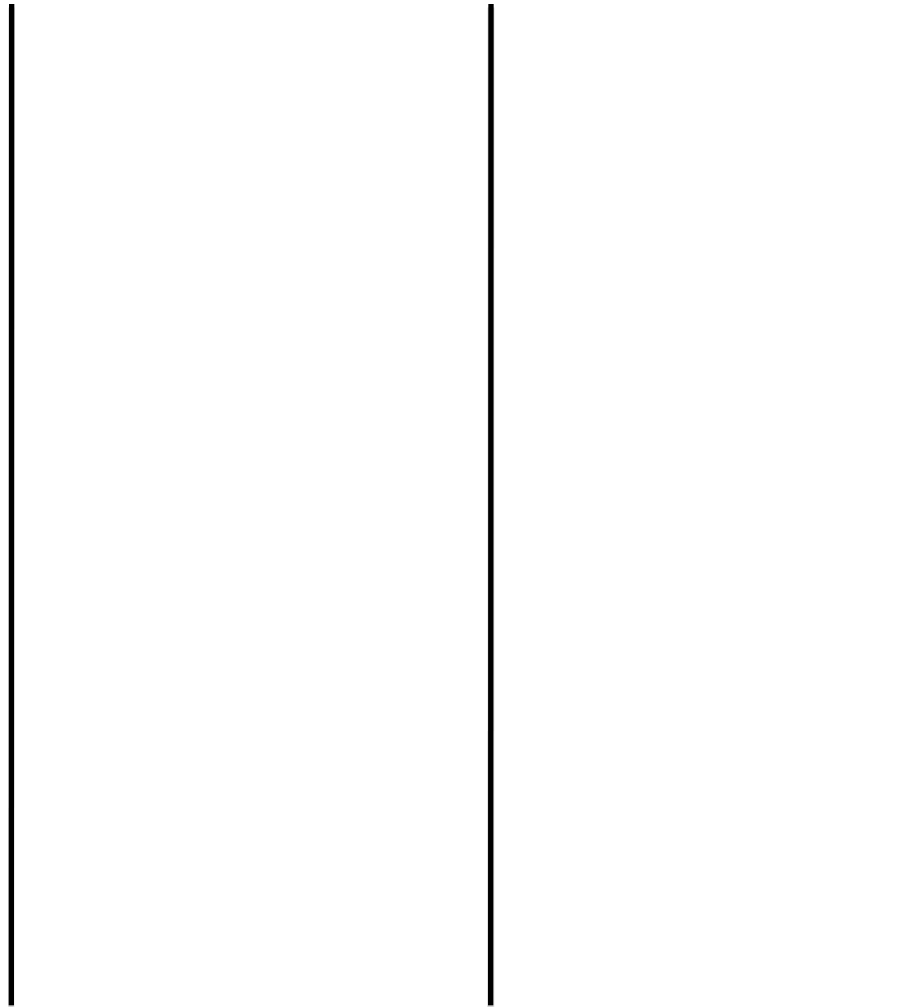
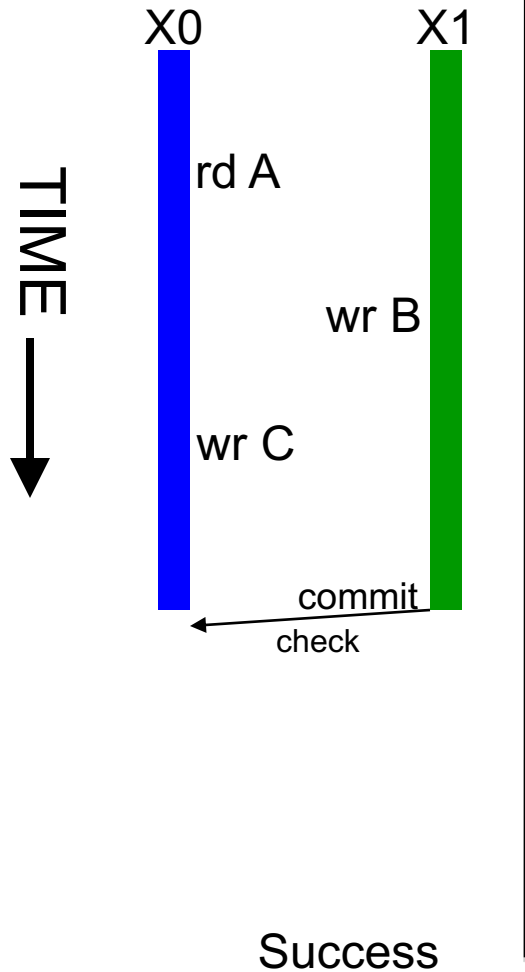

Optimistic Detection Illustration

Case 1

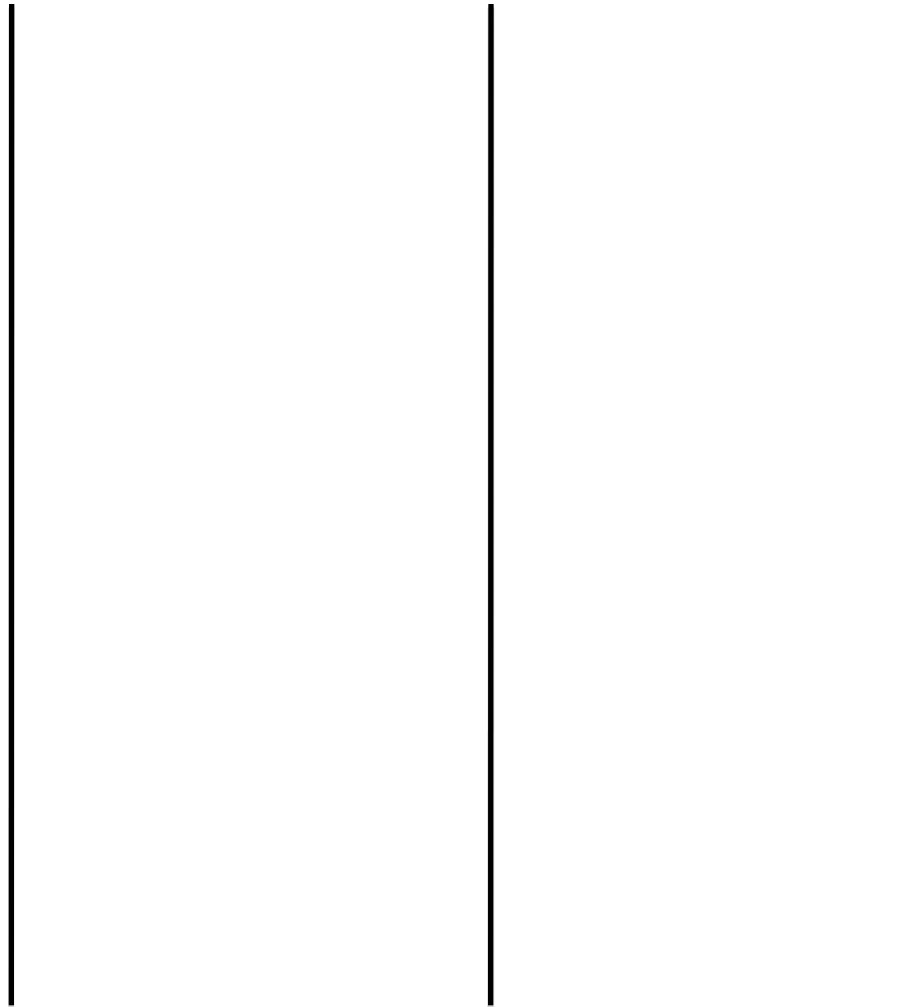
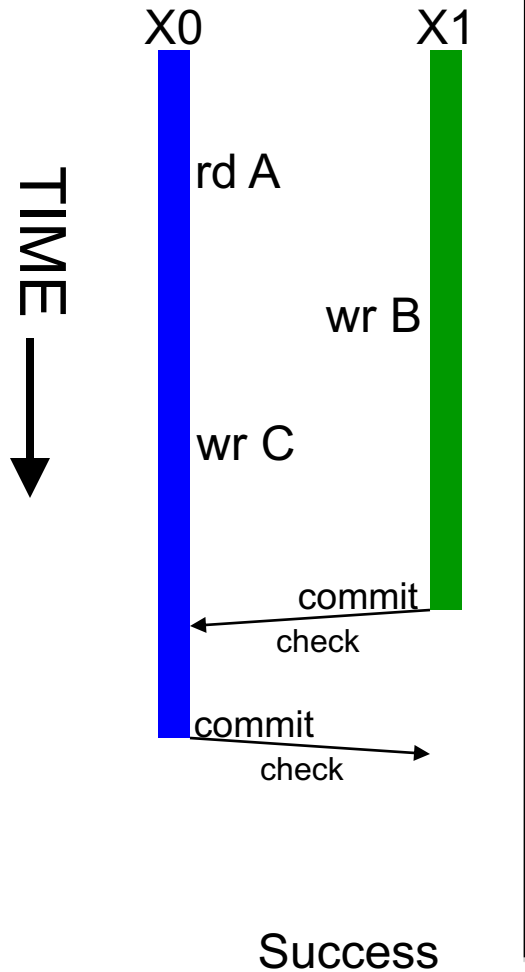

Optimistic Detection Illustration

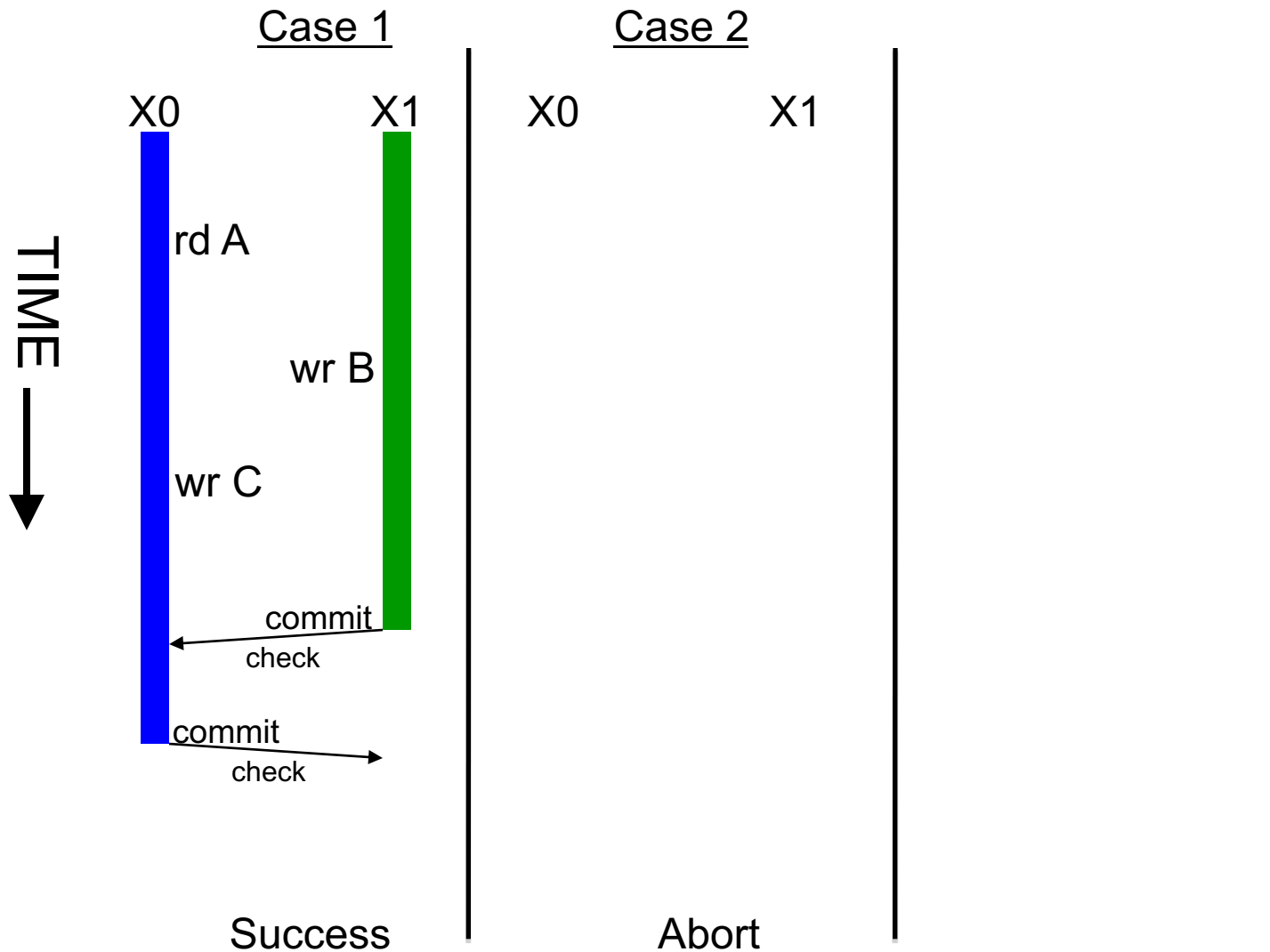

Optimistic Detection Illustration

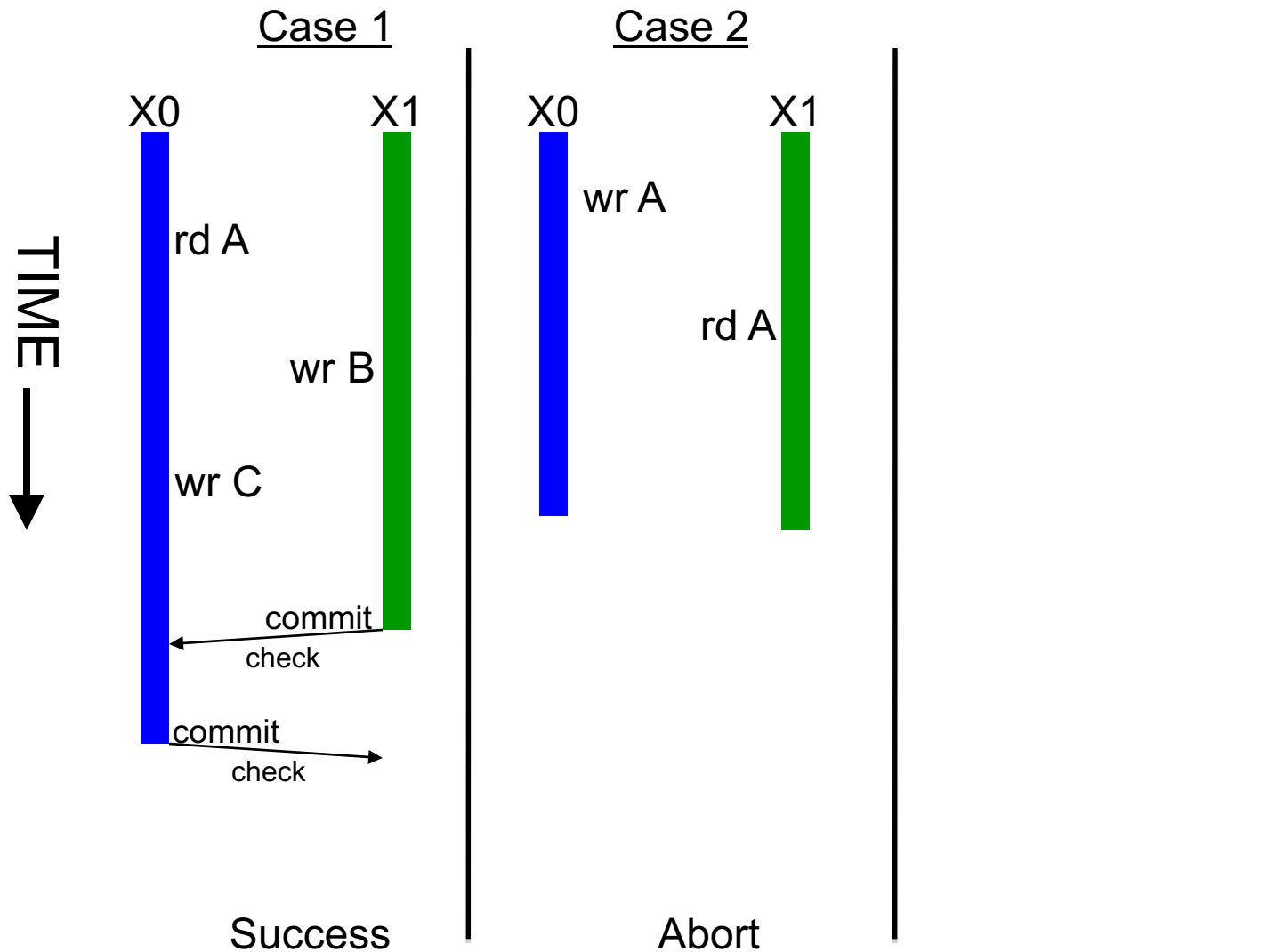

Optimistic Detection Illustration

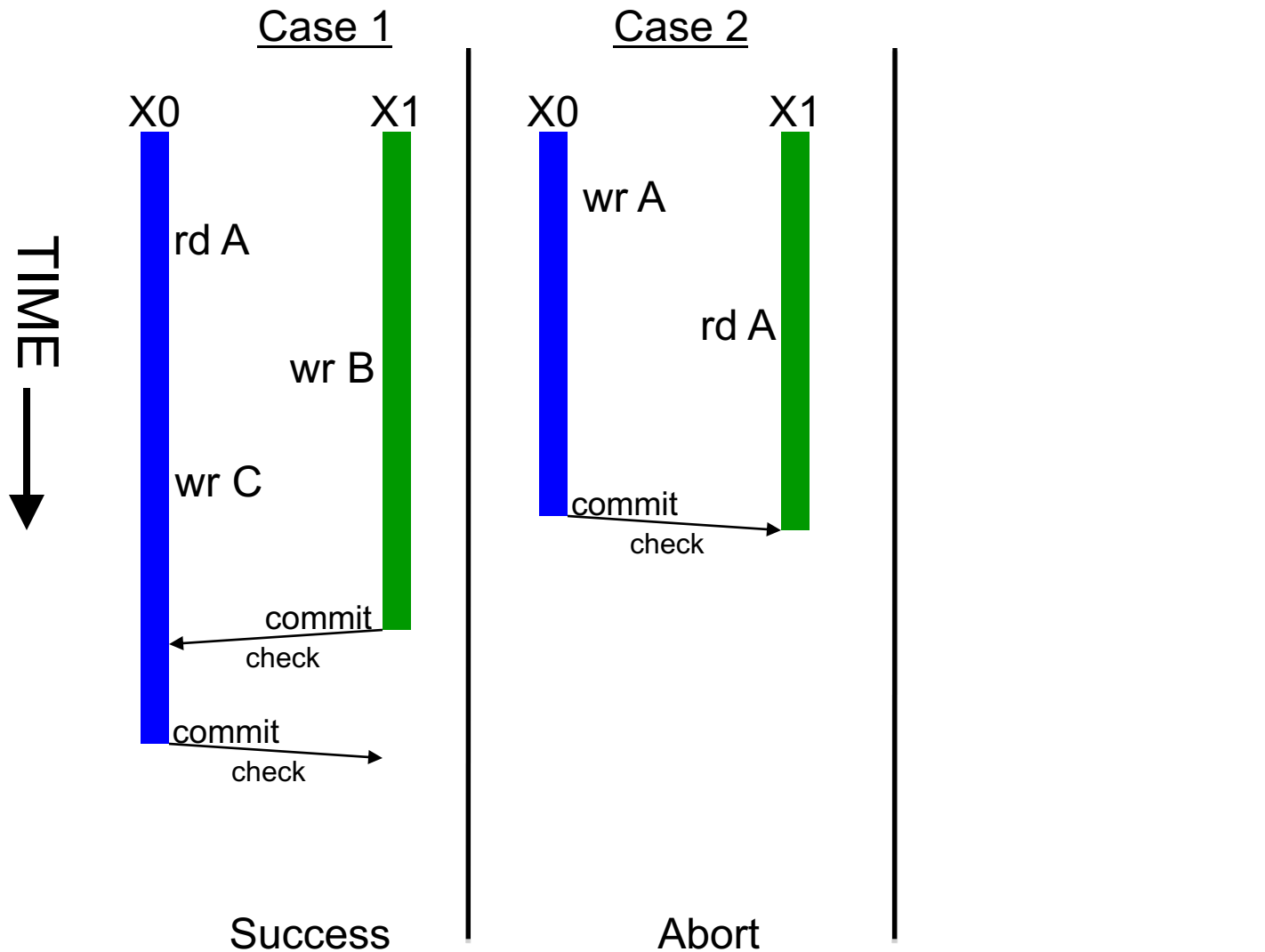

Optimistic Detection Illustration

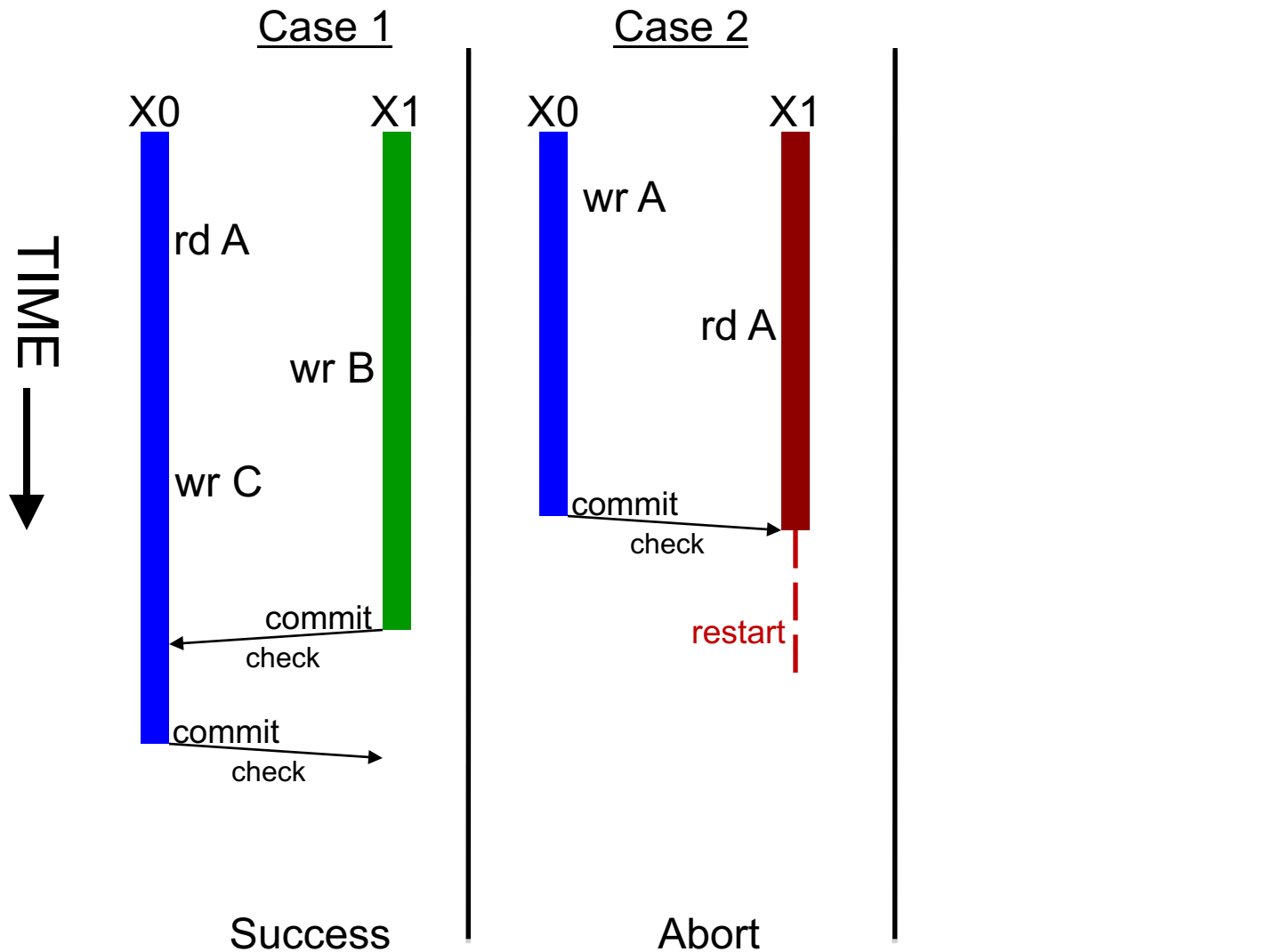

Optimistic Detection Illustration

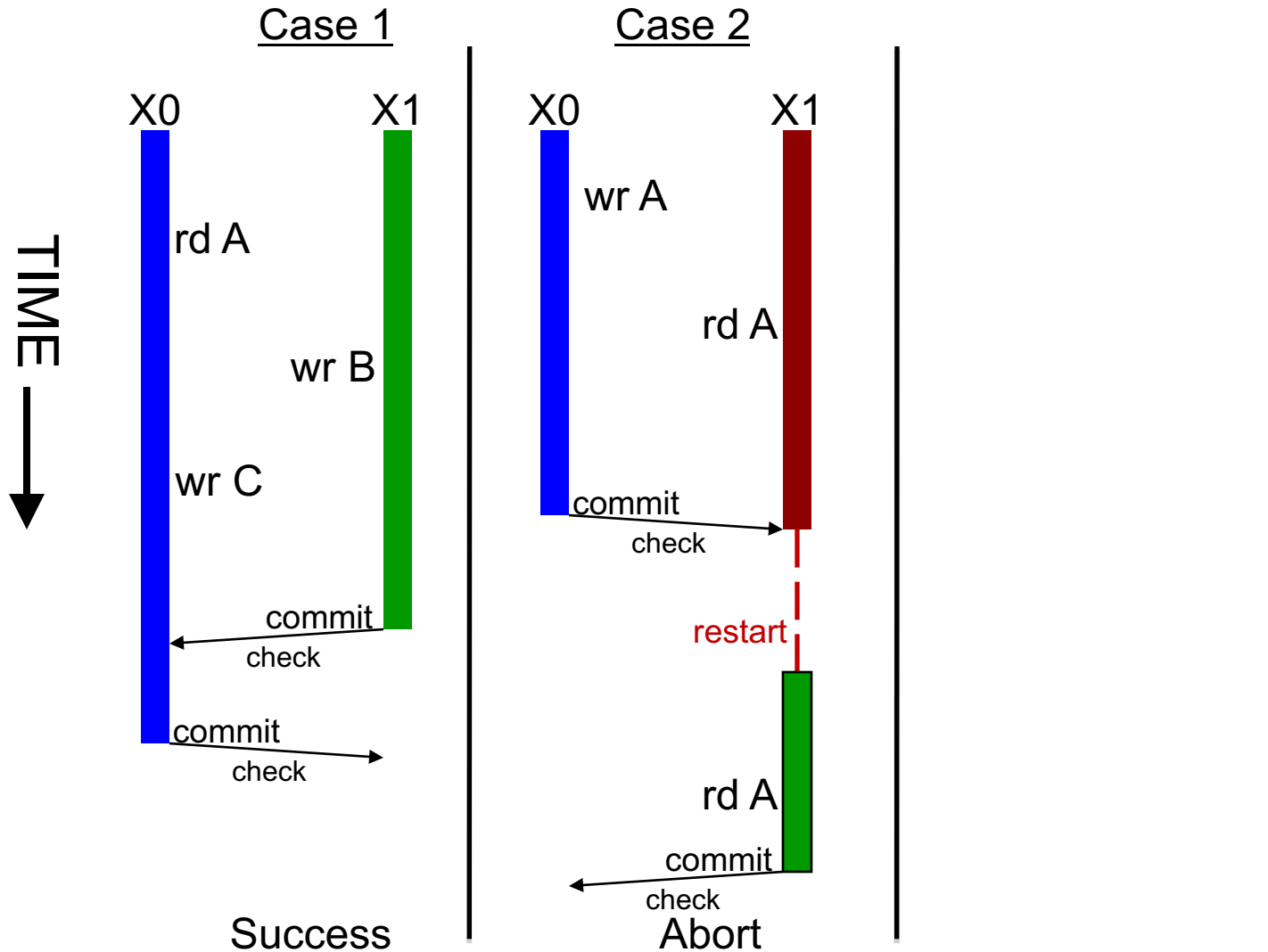

Optimistic Detection Illustration

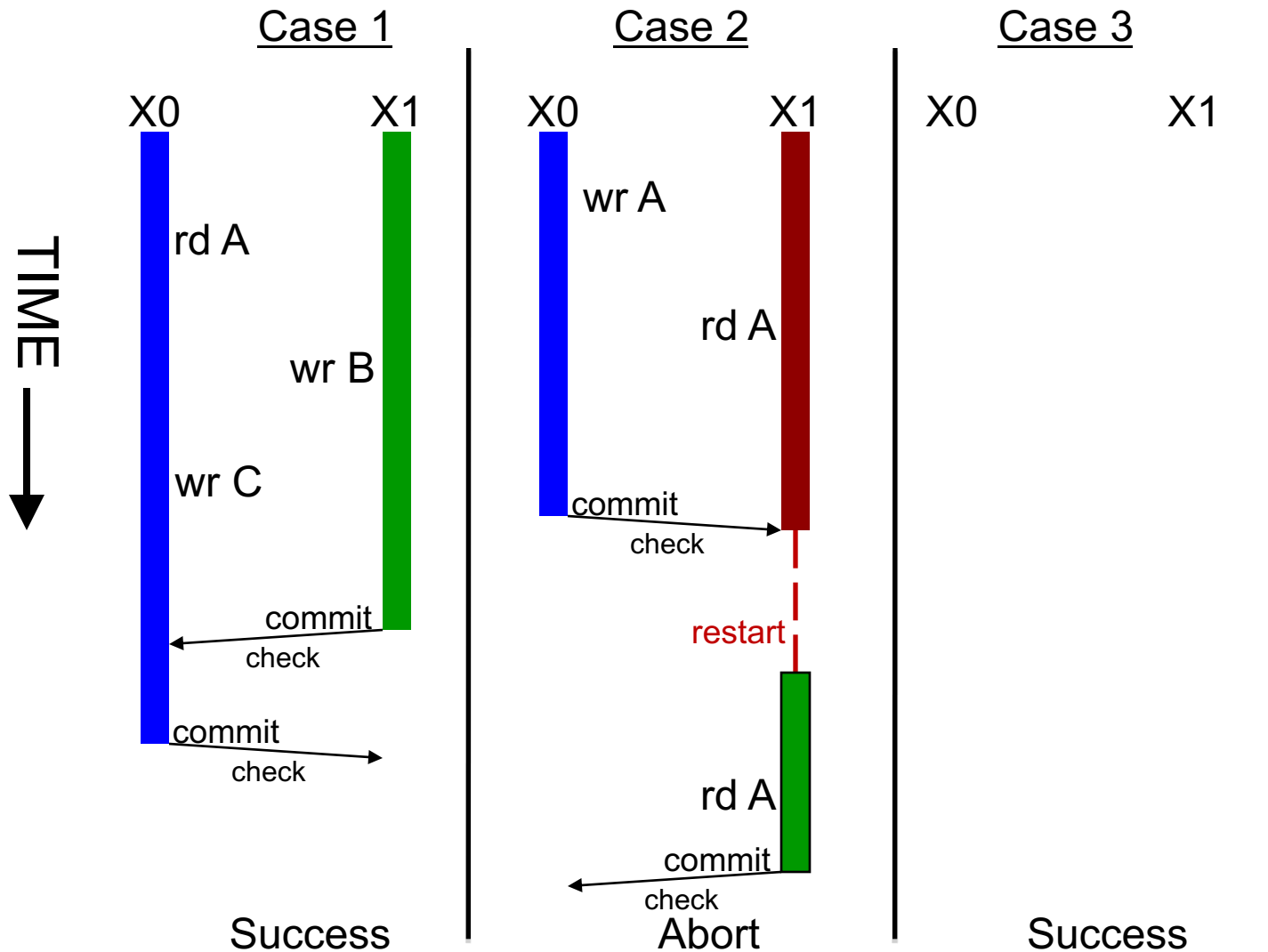

Optimistic Detection Illustration

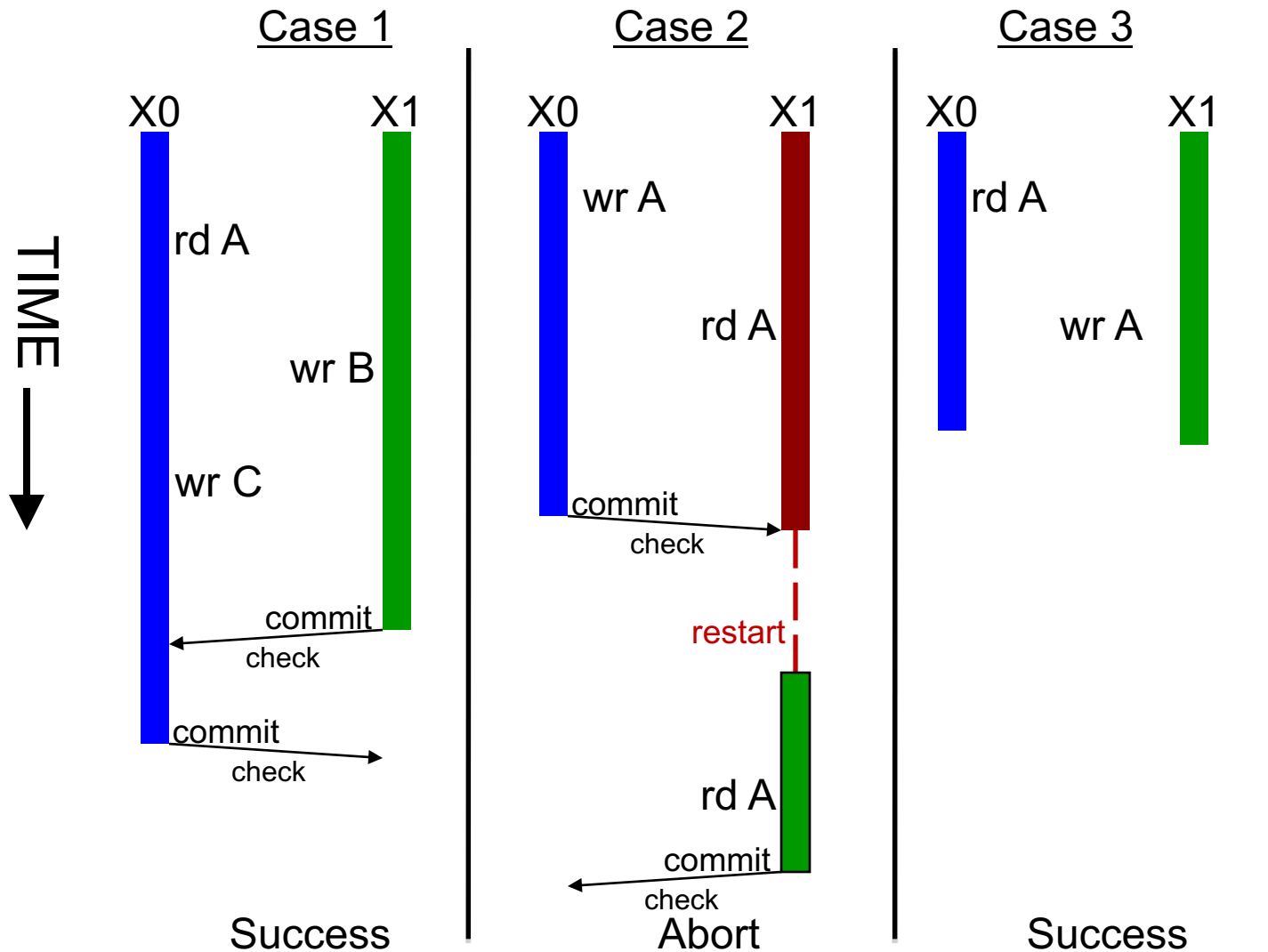

Optimistic Detection Illustration

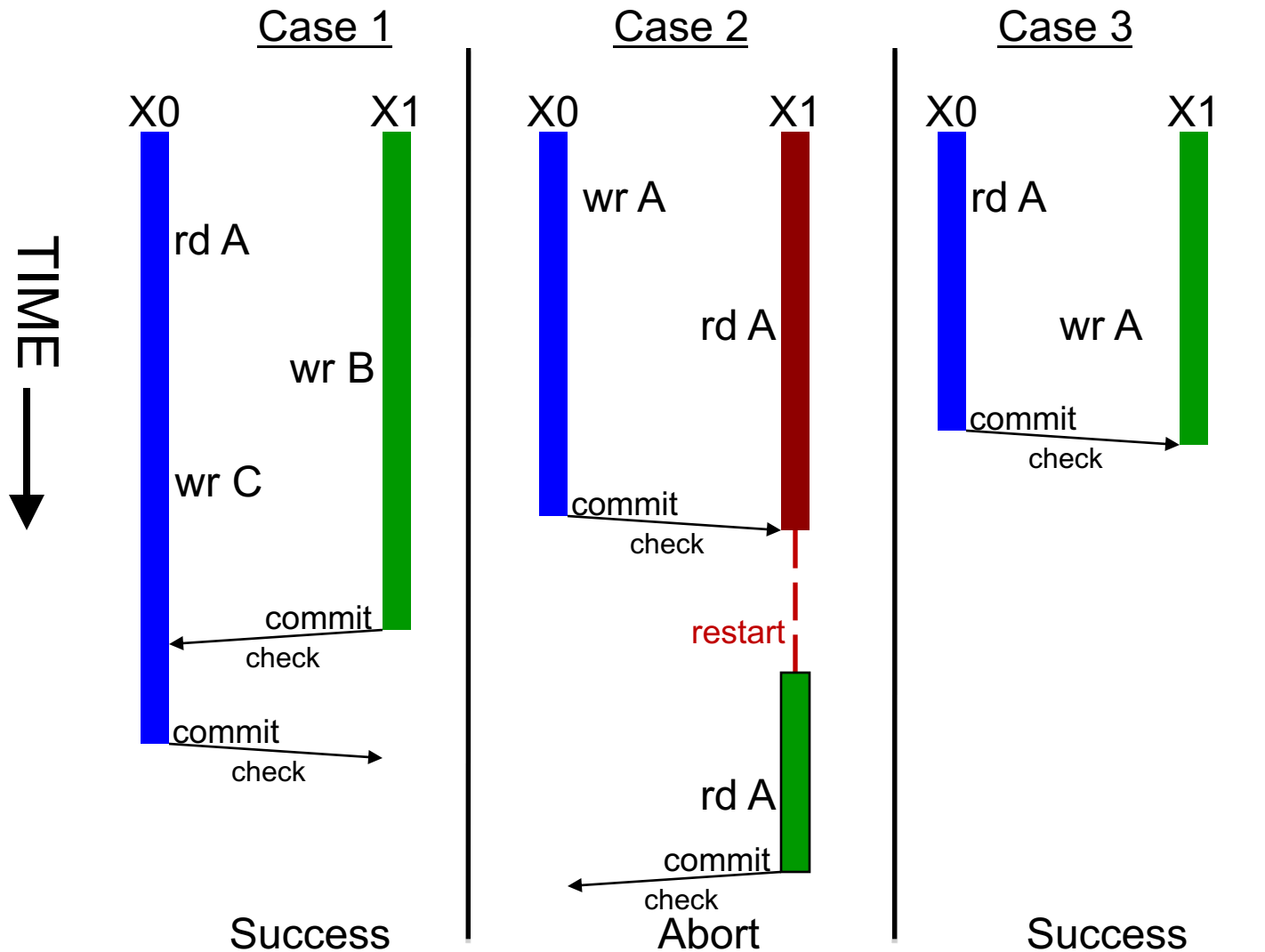

Optimistic Detection Illustration

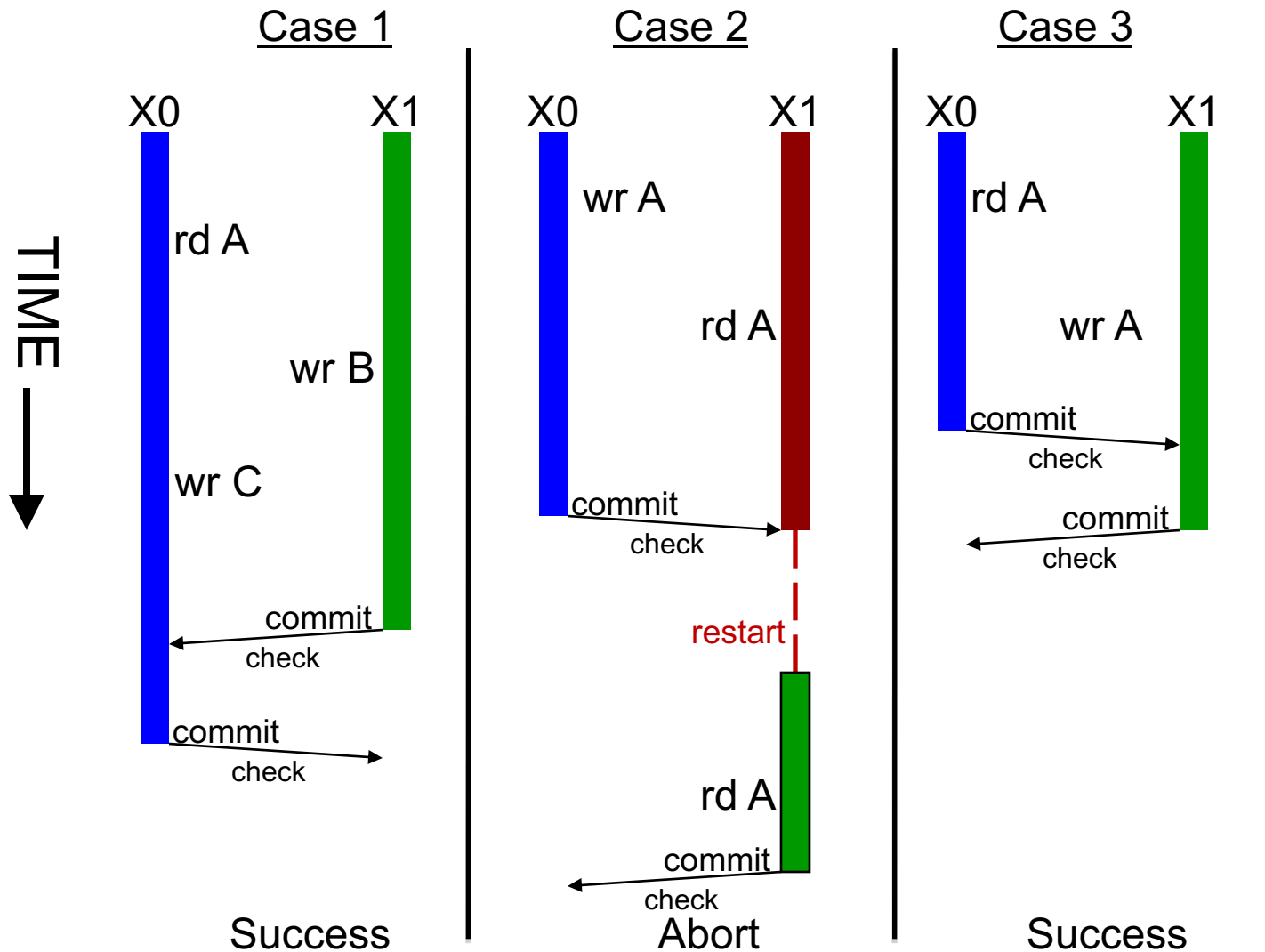

Optimistic Detection Illustration

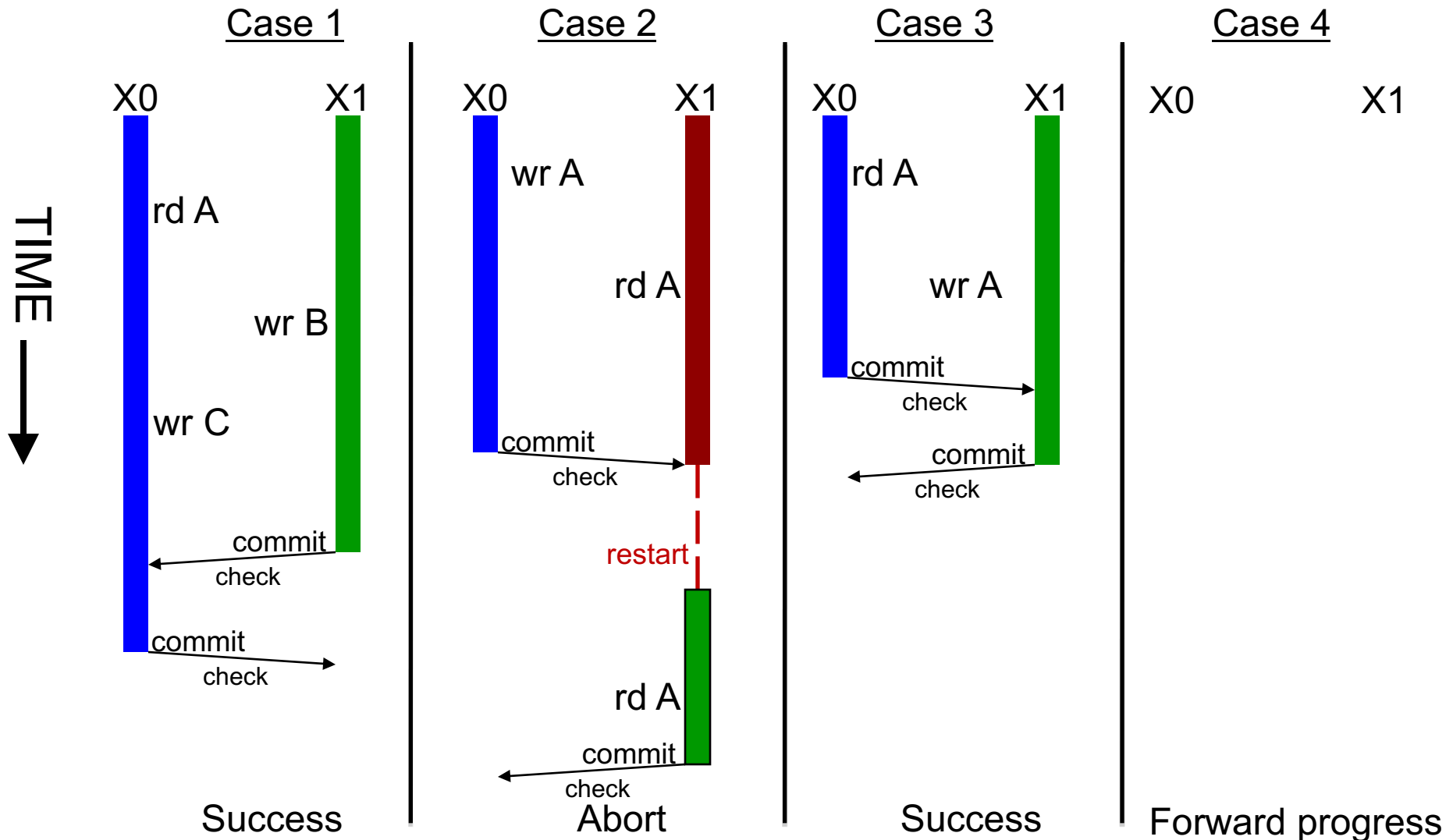

Optimistic Detection Illustration

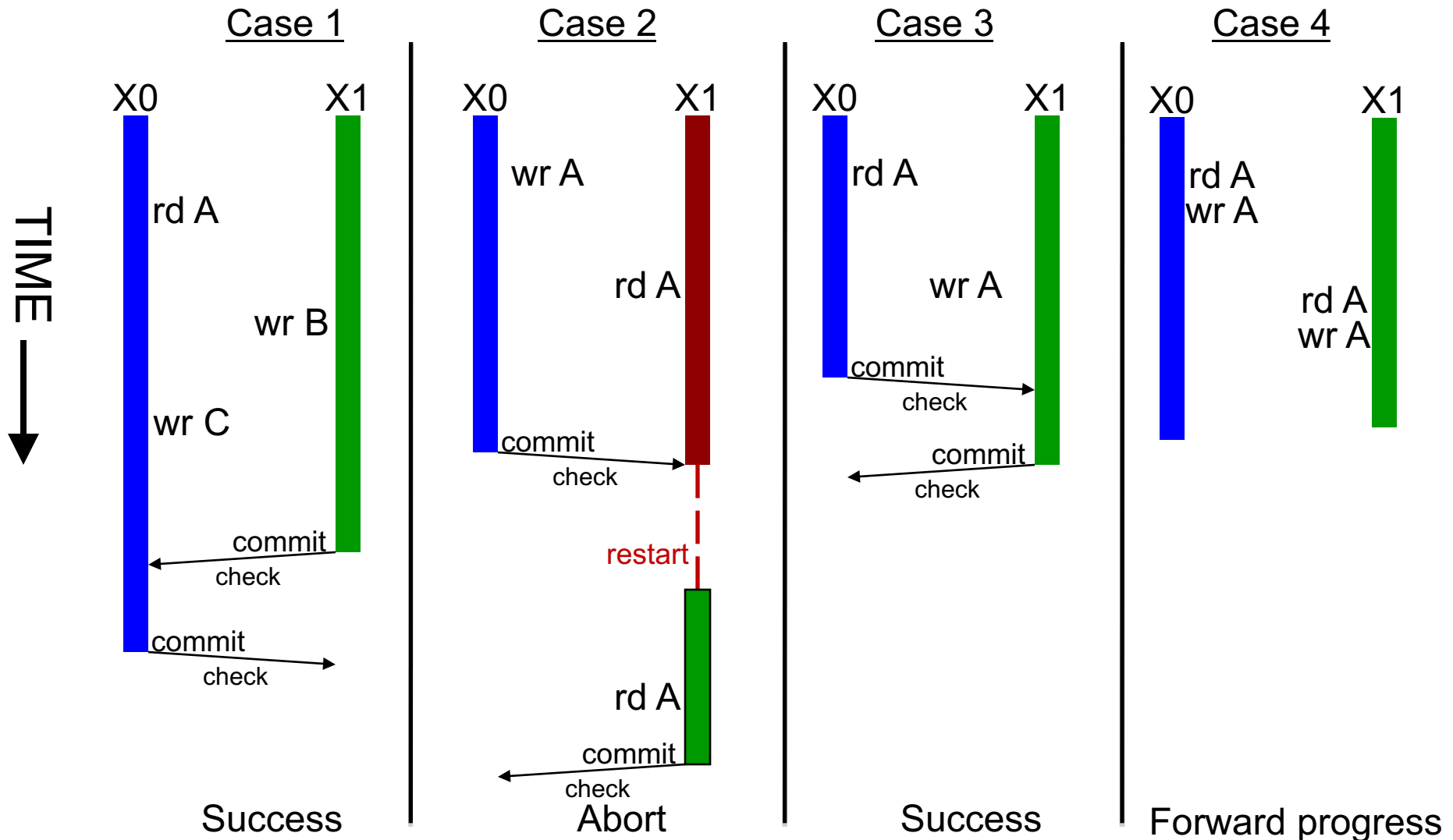

Optimistic Detection Illustration

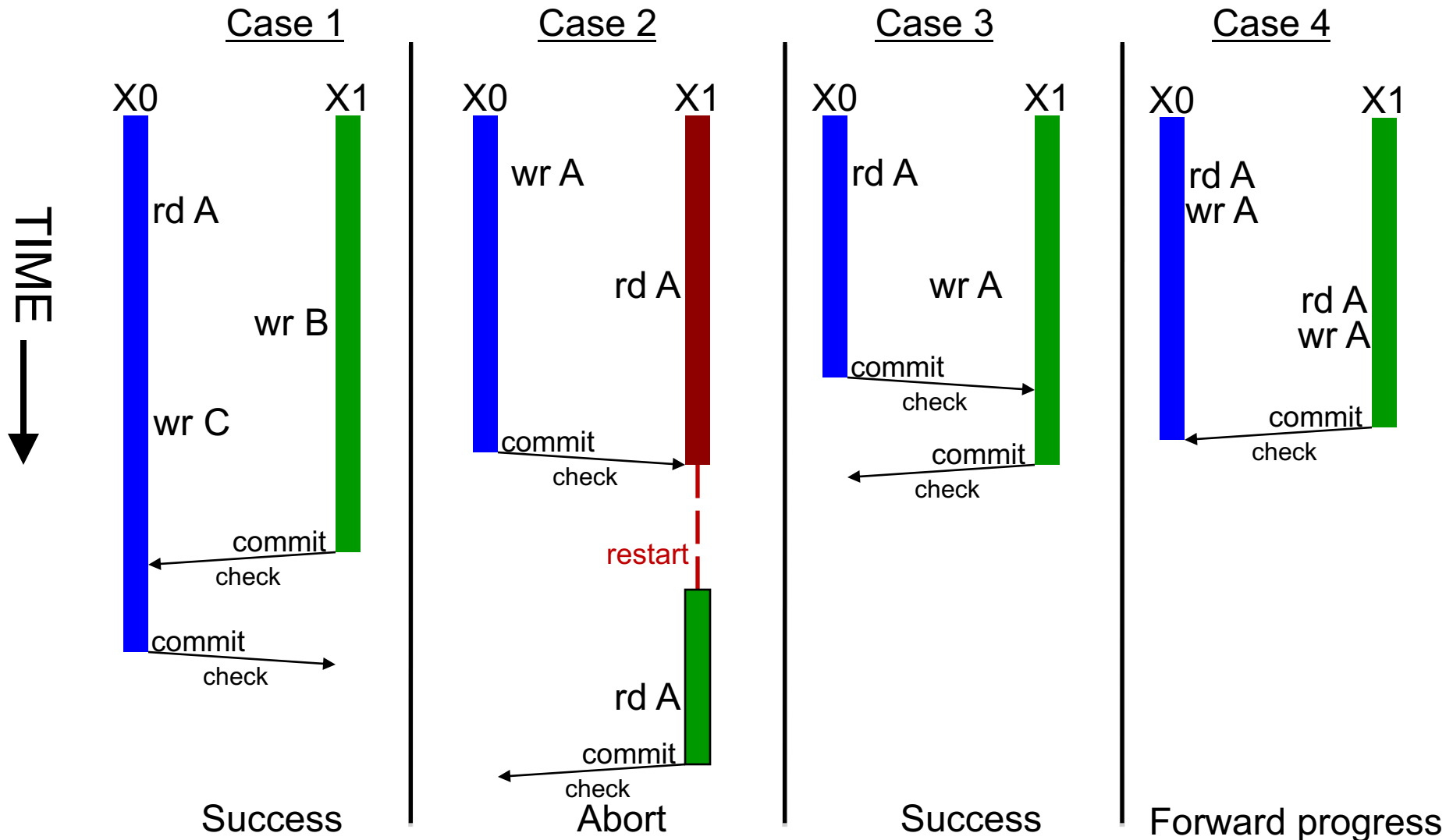

Optimistic Detection Illustration

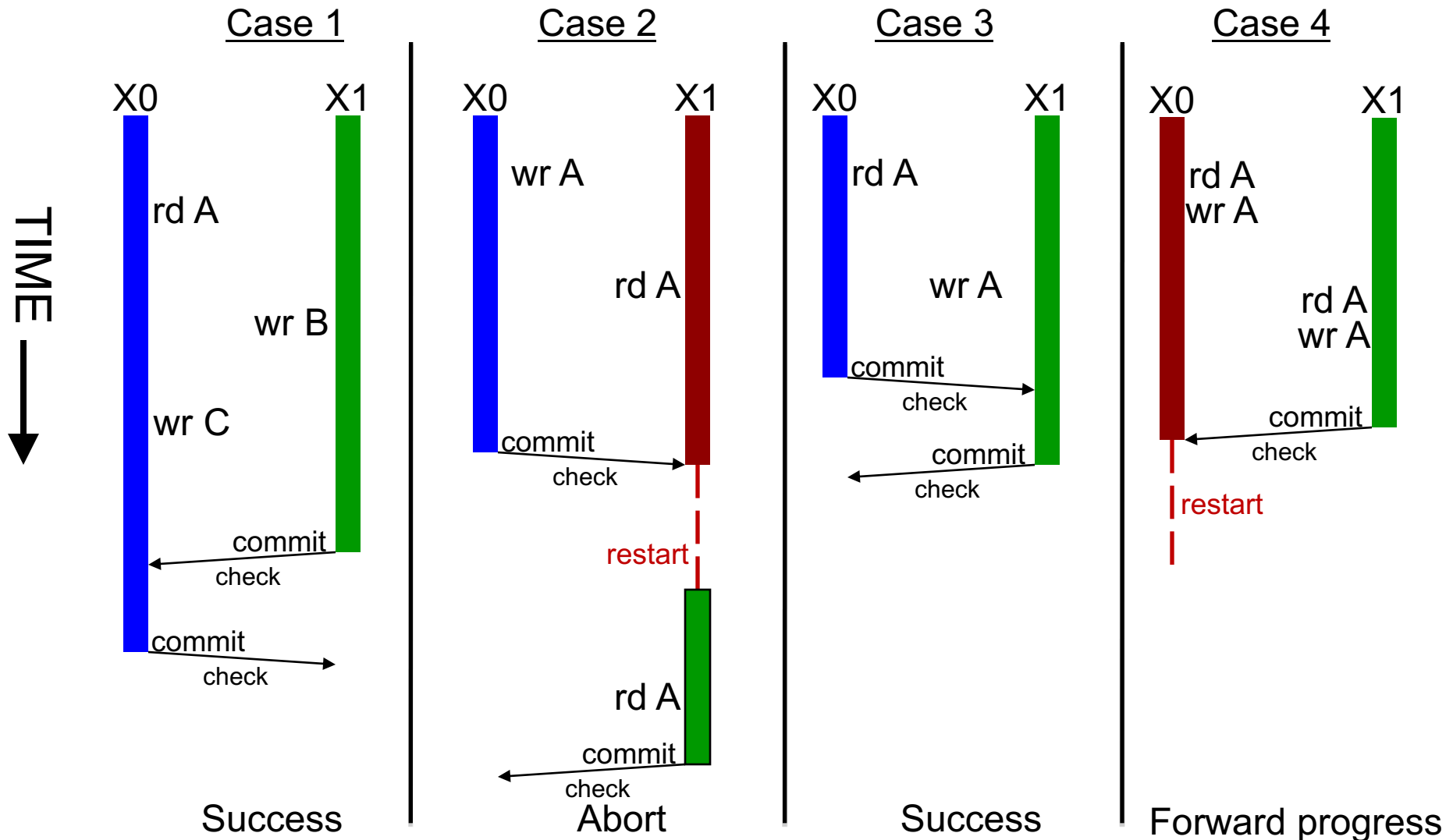

Optimistic Detection Illustration

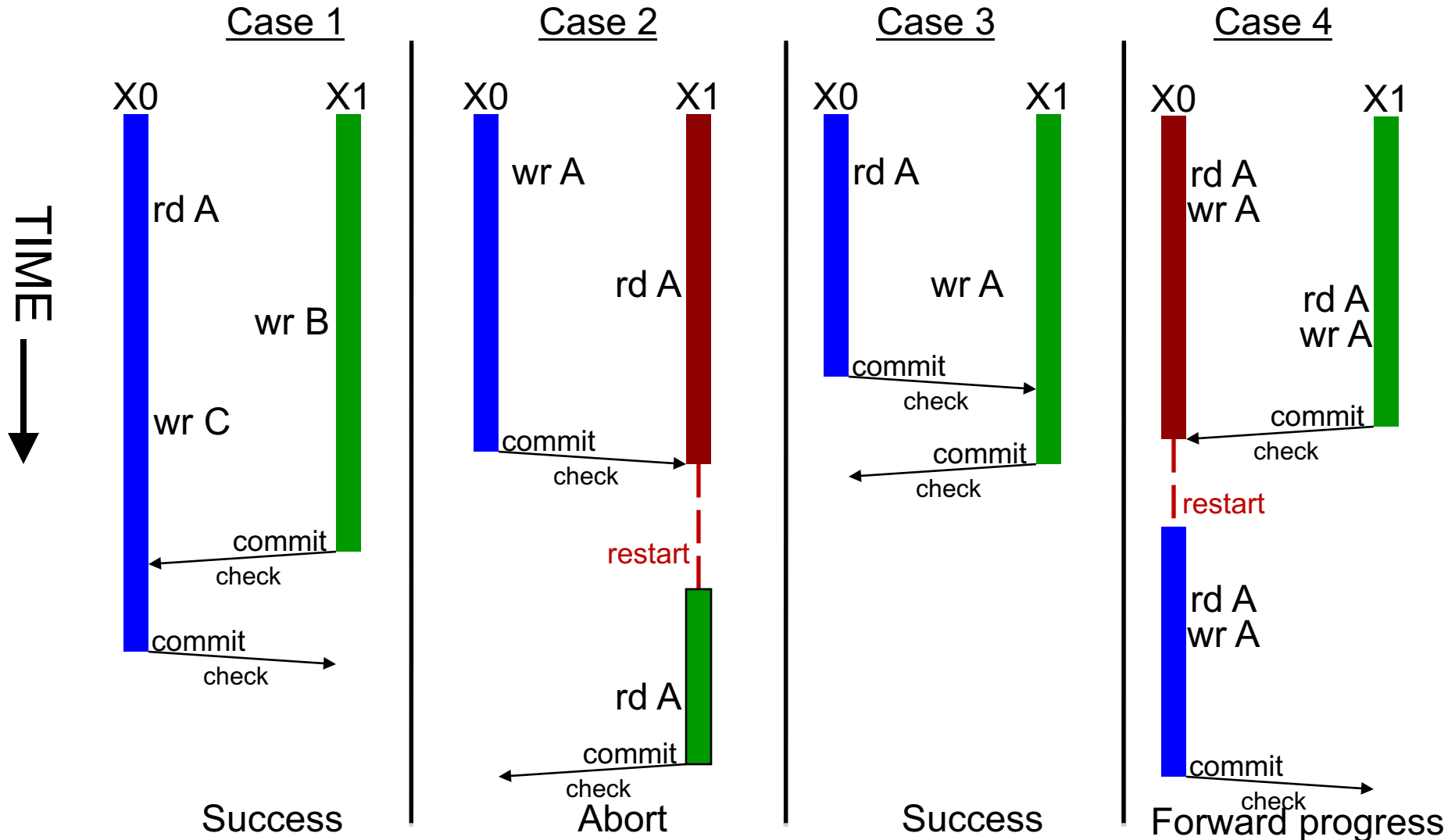

Conflict Detection Tradeoffs

1. Pessimistic conflict detection

- + Detect conflicts early
 - Undo less work, turn some aborts to stalls
- No forward progress guarantees, more aborts in some cases
 - Requires additional techniques to guarantee forward progress (e.g., backoff, prioritize older transactions)
- Locking issues (SW), fine-grain communication (HW)

2. Optimistic conflict detection

- + Forward progress guarantees
- + Potentially less conflicts, shorter locking (SW), bulk communication (HW)
- Detects conflicts late, still has fairness problems

HTM Implementation Overview

- Data versioning: Use caches
 - Cache the write-buffer or the undo-log
 - Cache metadata to track read-set and write-set
 - Can do with private, shared, and multi-level caches

HTM Implementation Overview

- Data versioning: Use caches
 - Cache the write-buffer or the undo-log
 - Cache metadata to track read-set and write-set
 - Can do with private, shared, and multi-level caches
- Conflict detection: Use the cache coherence protocol
 - Coherence lookups detect conflicts between transactions
 - Works with snooping & directory coherence

HTM Implementation Overview

- Data versioning: Use caches
 - Cache the write-buffer or the undo-log
 - Cache metadata to track read-set and write-set
 - Can do with private, shared, and multi-level caches
- Conflict detection: Use the cache coherence protocol
 - Coherence lookups detect conflicts between transactions
 - Works with snooping & directory coherence
- Note: On aborts, must also restore register state → take register checkpoint
 - OOO cores support with minimal changes (recall rename table snapshots...)

HTM Design

- Cache lines track read-set & write-set
 - R bit: indicates data read by transaction; set on load
 - W bit: indicates data written by transaction; set on store
 - R/W bits can be at word or cache-line granularity
 - R/W bits gang-cleared on transaction commit or abort

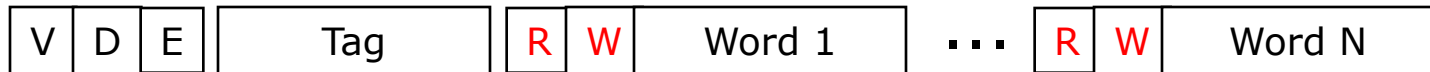

- Coherence requests check R/W bits to detect conflicts
 - Shared request to W-word is a read-write conflict
 - Exclusive request to R-word is a write-read conflict
 - Exclusive request to W-word is a write-write conflict

Example HTM: Lazy Optimistic

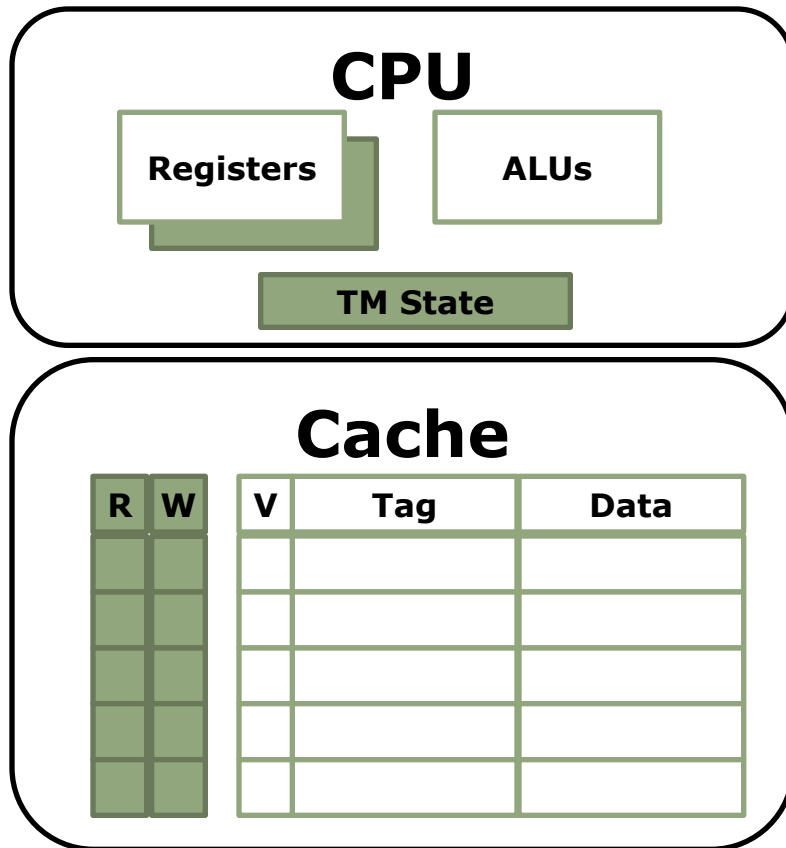

- CPU changes
 - Register checkpoint
 - TM state registers (status, pointers to handlers, ...)
- Cache changes
 - Per-line R/W bits
- Assume a bus-based system

HTM Transaction Execution

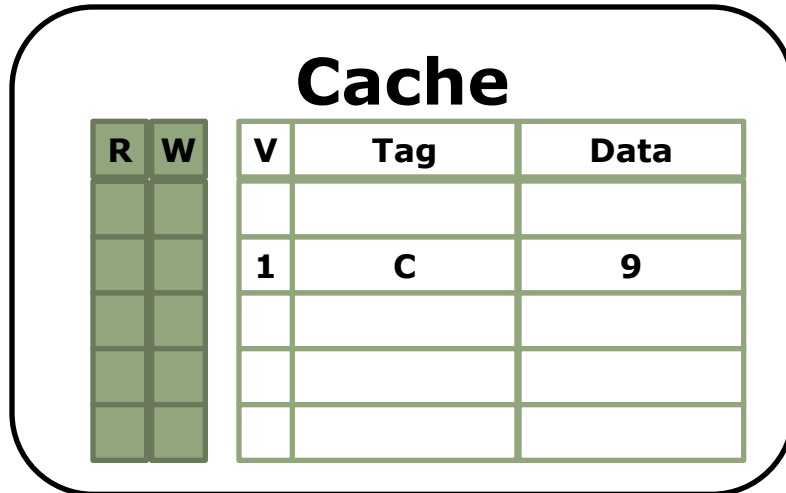
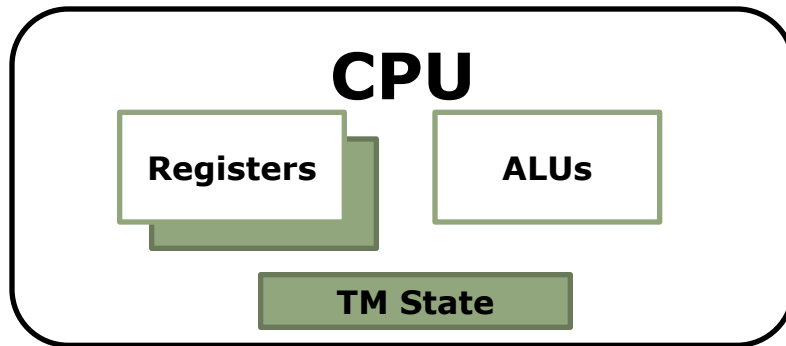

Xbegin

Load A

Store B \leftarrow 5

Load C

Xcommit

HTM Transaction Execution

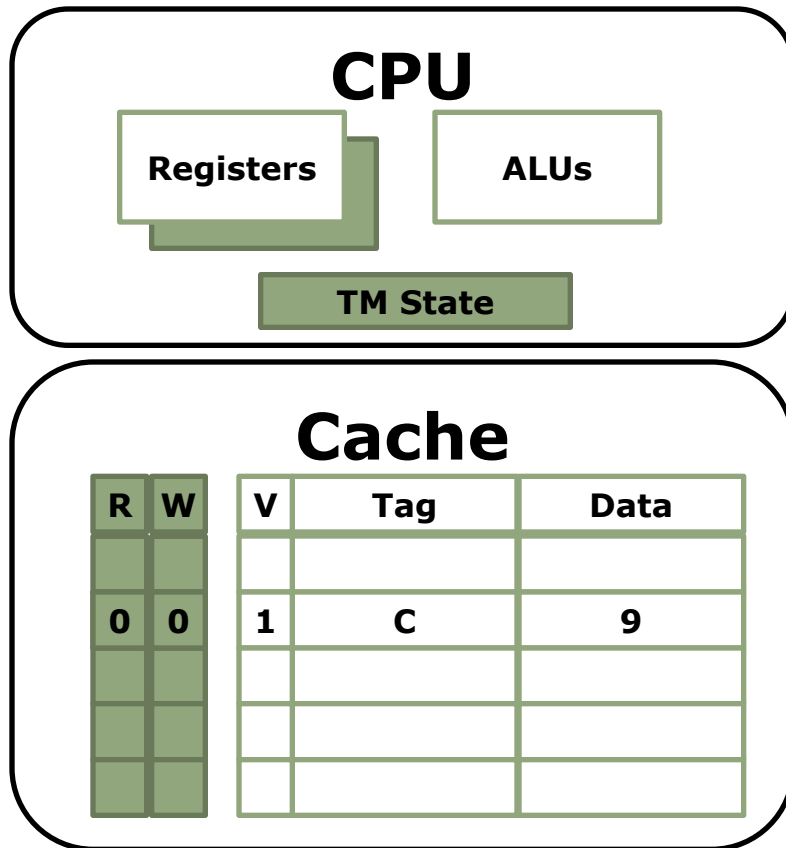

Xbegin ←

Load A

Store B ← 5

Load C

Xcommit

- Transaction begin
 - Initialize CPU & cache state
 - Take register checkpoint

HTM Transaction Execution

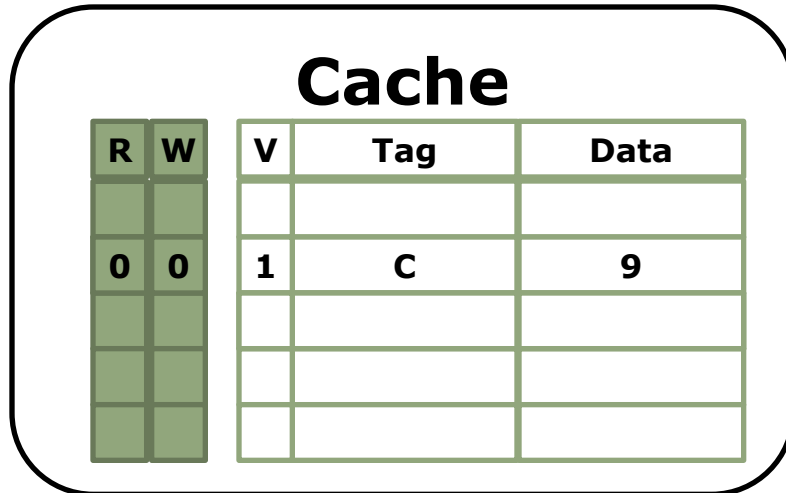
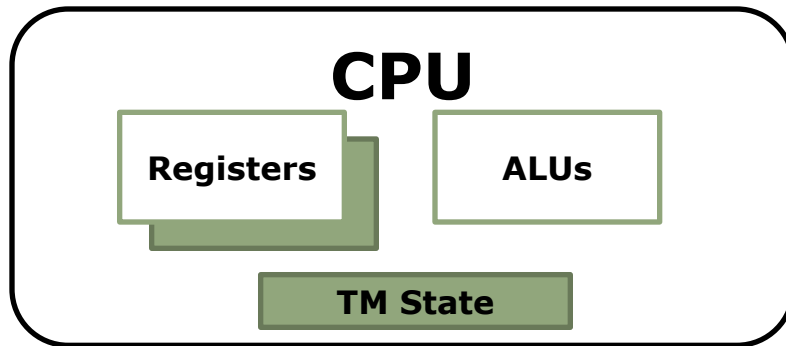

Xbegin

Load A ←

Store B ← 5

Load C

Xcommit

HTM Transaction Execution

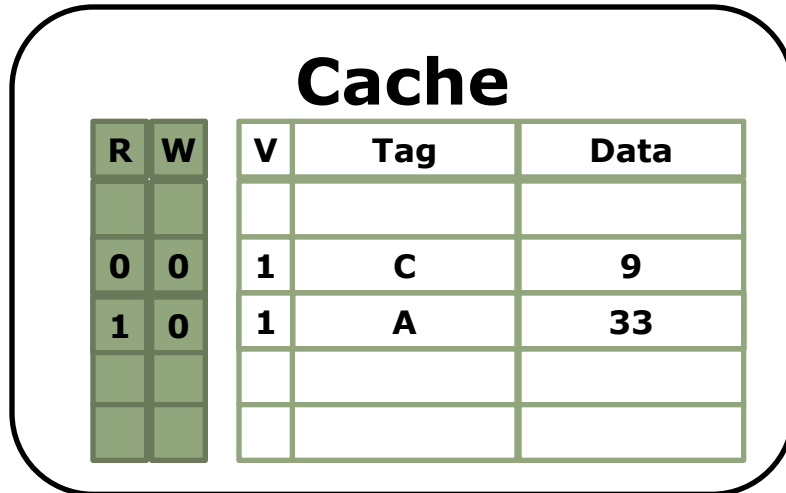
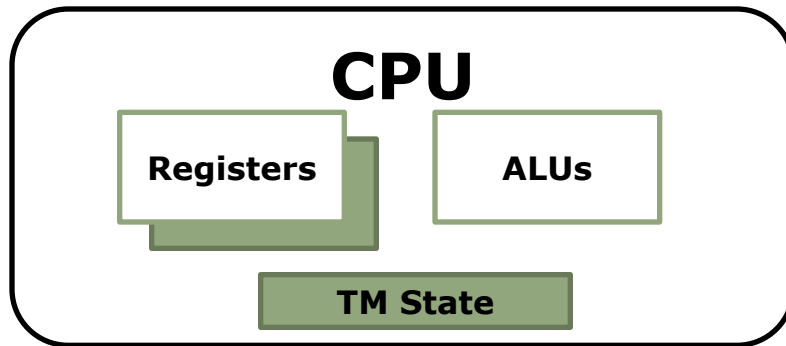

Xbegin

Load A ←

Store B ← 5

Load C

Xcommit

- Load operation
 - Serve cache miss if needed
 - Set line's R-bit

HTM Transaction Execution

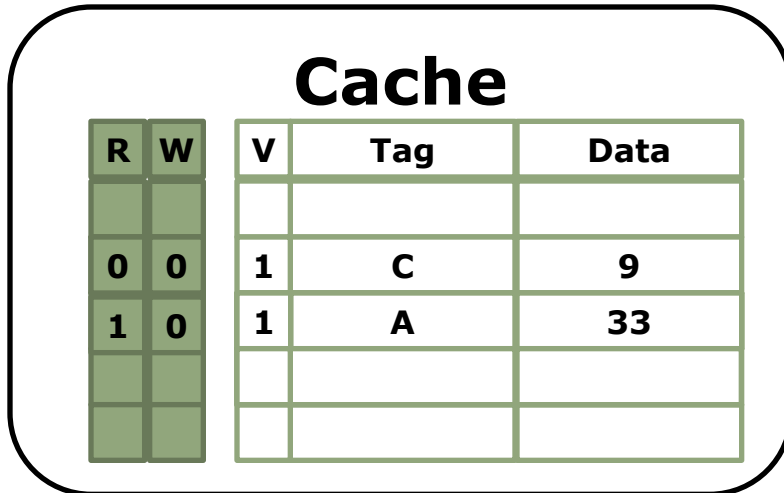
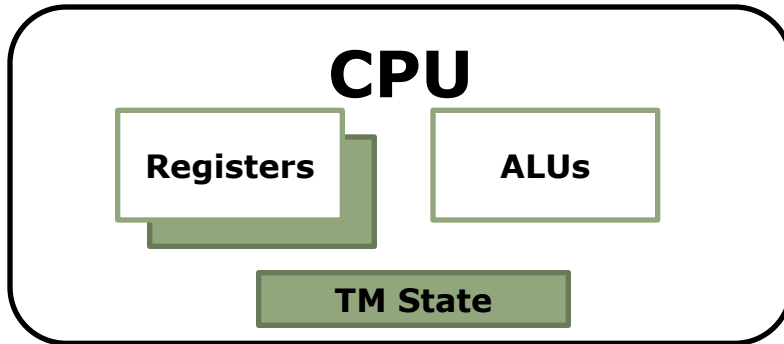

Xbegin

Load A

Store B \leftarrow 5 \leftarrow

Load C

Xcommit

HTM Transaction Execution

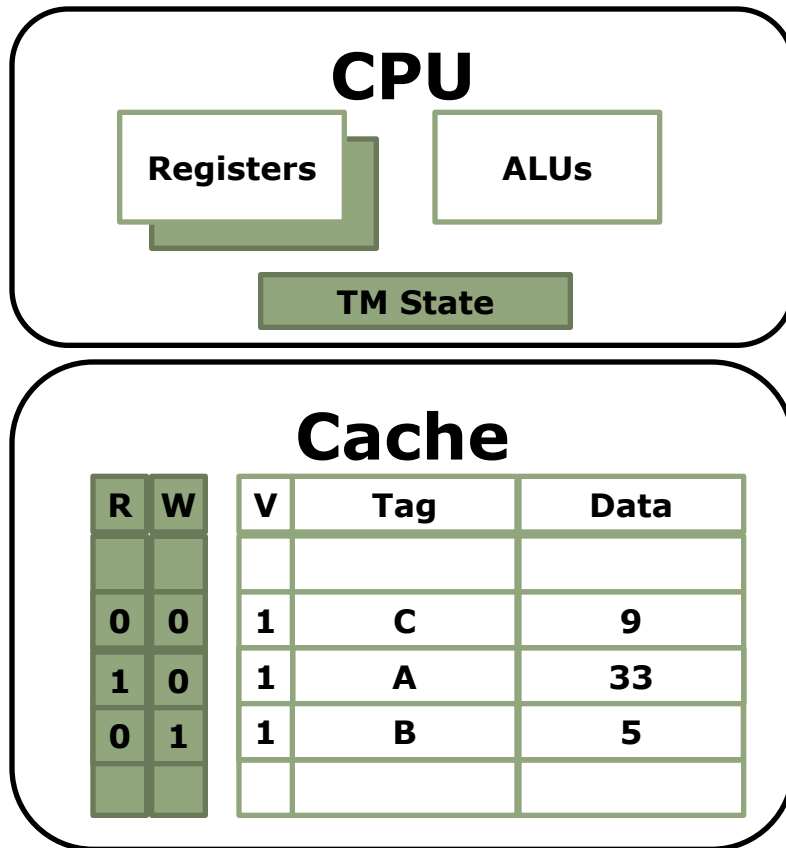

Xbegin

Load A

Store B \leftarrow 5 \leftarrow

Load C

Xcommit

- Store operation
 - Serve cache miss if needed (if other cores have line, get it shared anyway!)
 - Set line's W-bit

HTM Transaction Execution

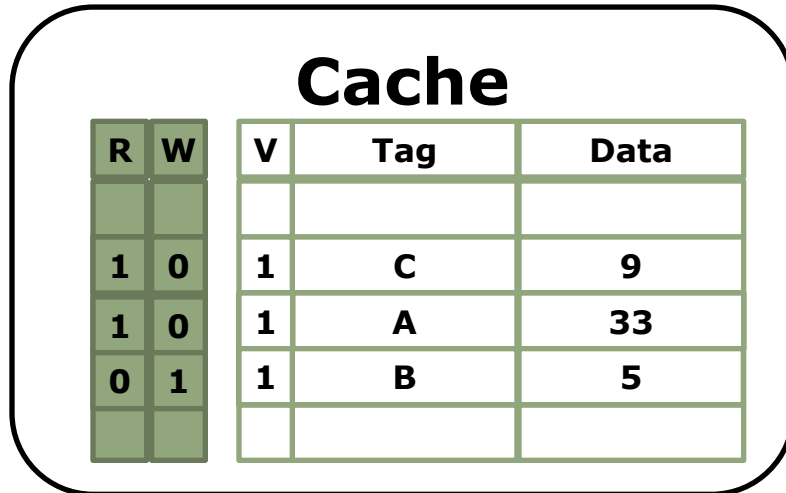
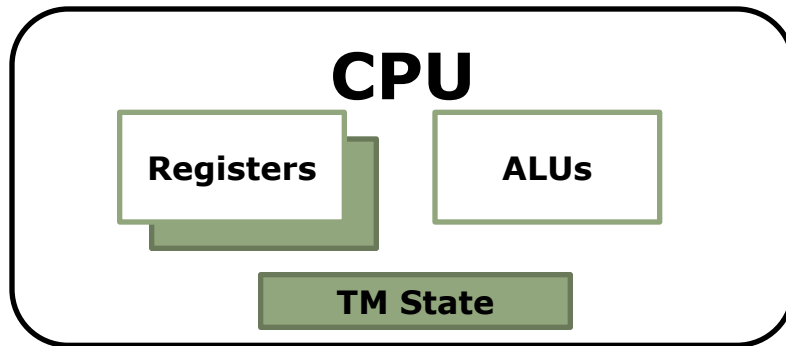

Xbegin

Load A

Store B \leftarrow 5

Load C

Xcommit \leftarrow

HTM Transaction Execution

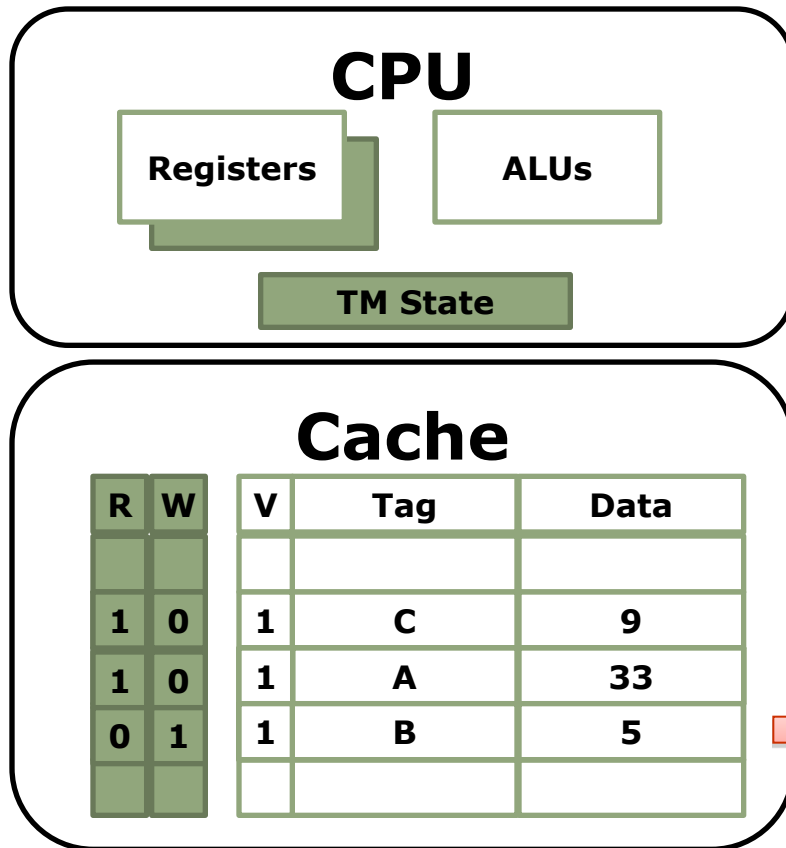

Xbegin

Load A

Store B \leftarrow 5

Load C

Xcommit \leftarrow

- Fast 2-phase commit:
 1. Validate: Request exclusive access to write-set lines (if needed)

HTM Transaction Execution

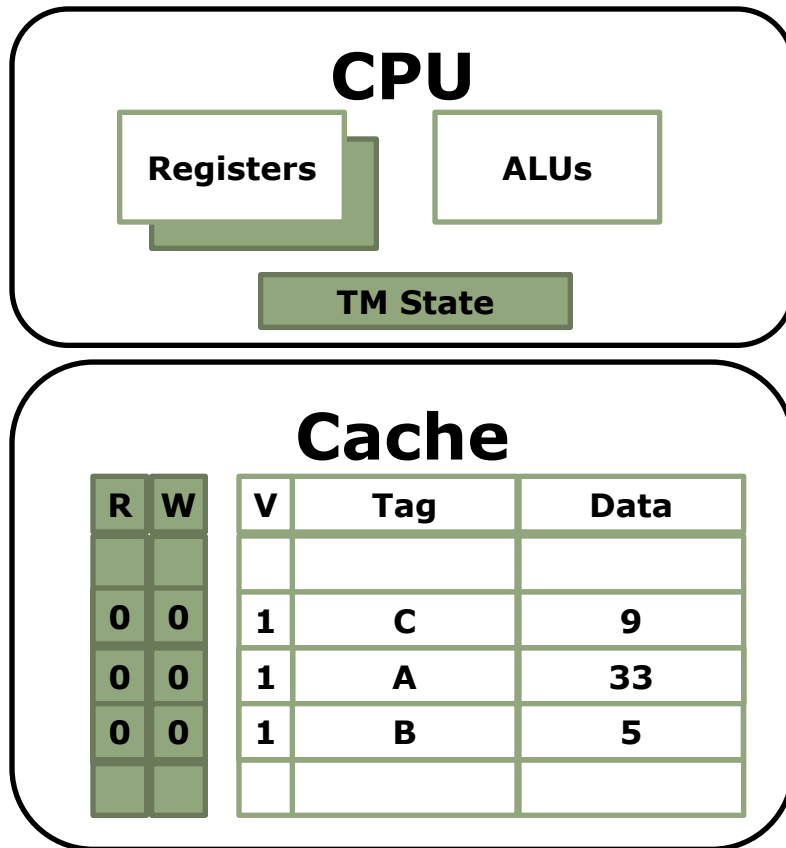

Xbegin

Load A

Store B \leftarrow 5

Load C

Xcommit \leftarrow

- Fast 2-phase commit:
 1. Validate: Request exclusive access to write-set lines (if needed)
 2. Commit: Gang-reset R&W bits, turns write-set data to valid (dirty) data

HTM Conflict Detection

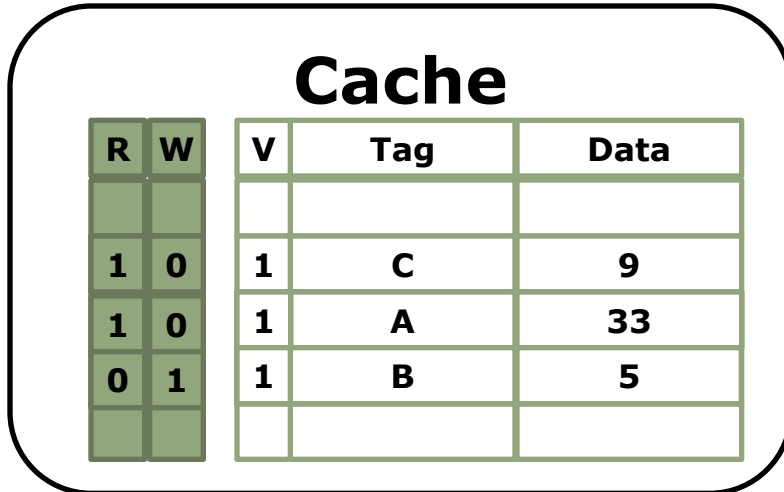
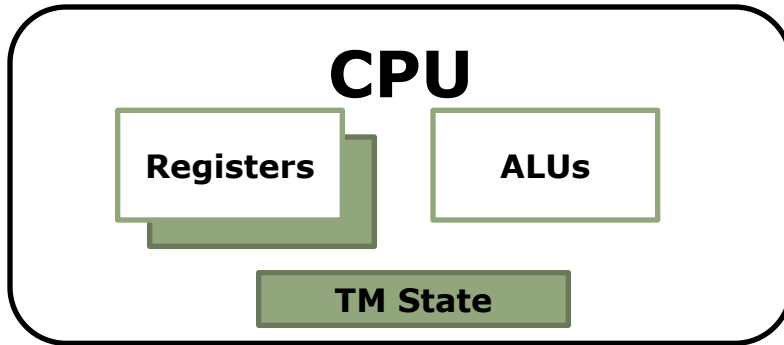

Xbegin

Load A

Store B \leftarrow 5

Load C \leftarrow

Xcommit

- Fast conflict detection & abort:

HTM Conflict Detection

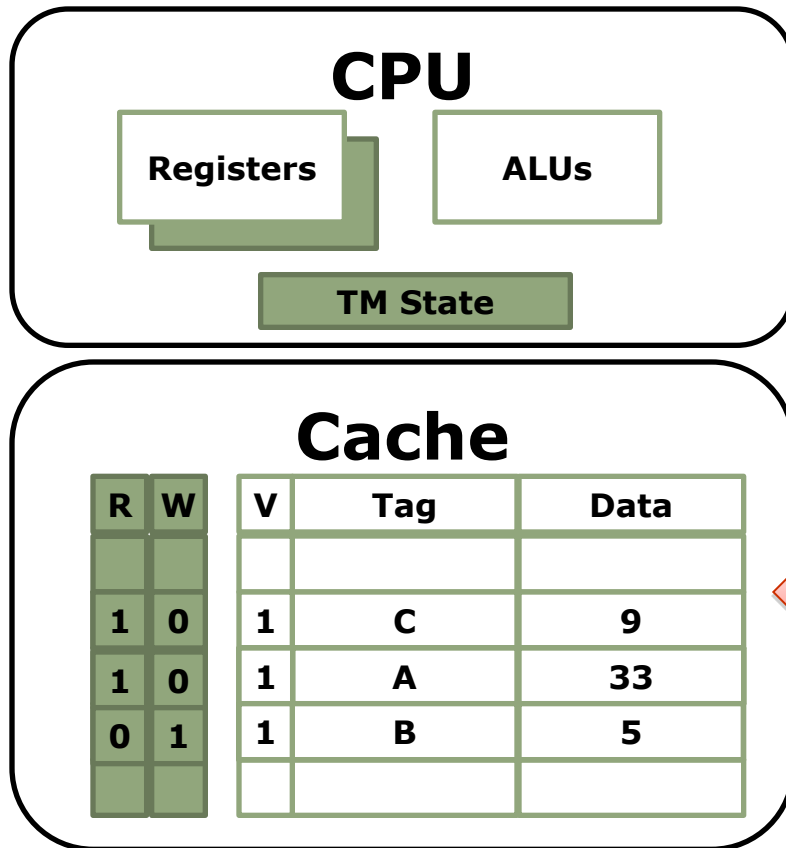

Xbegin

Load A

Store B \leftarrow 5

Load C \leftarrow

Xcommit

 upgradeX D

- Fast conflict detection & abort:
 - Check: Lookup exclusive requests in the read-set and write-set

HTM Conflict Detection

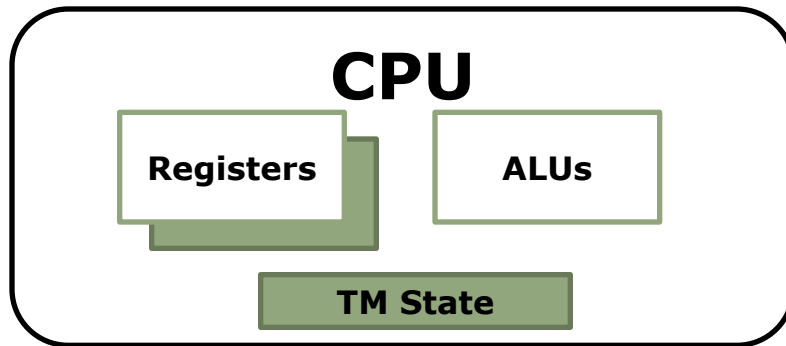

Xbegin

Load A

Store B \leftarrow 5

Load C \leftarrow

Xcommit

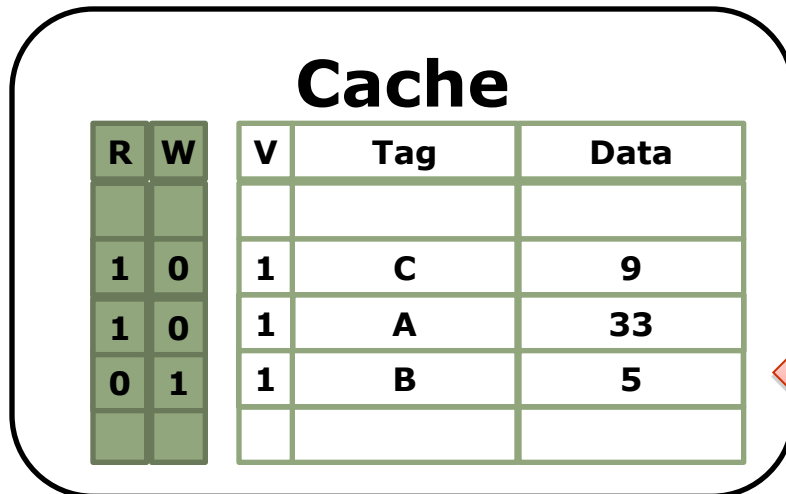

\leftarrow upgradeX A

- Fast conflict detection & abort:
 - Check: Lookup exclusive requests in the read-set and write-set
 - Abort: Invalidate write-set, gang-reset R and W bits, restore checkpoint

HTM Conflict Detection

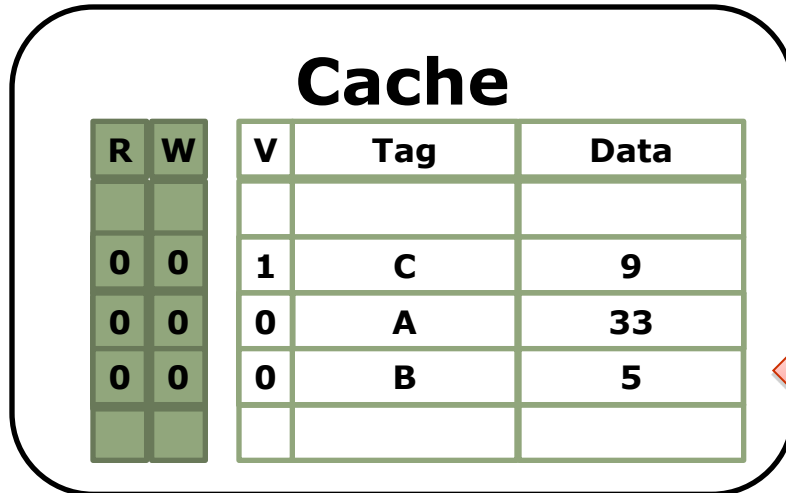
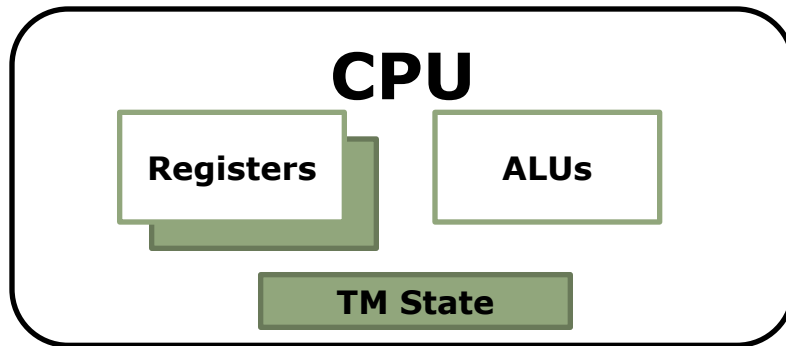

Xbegin

Load A

Store B \leftarrow 5

Load C \leftarrow

Xcommit

\leftarrow upgradeX A \boxtimes

- Fast conflict detection & abort:
 - Check: Lookup exclusive requests in the read-set and write-set
 - Abort: Invalidate write-set, gang-reset R and W bits, restore checkpoint

HTM Advantages

- Fast common-case behavior
 - Zero-overhead tracking of read-set & write-set
 - Zero-overhead versioning
 - Fast commits & aborts without data movement
 - Continuous validation of read-set

HTM Advantages

- Fast common-case behavior
 - Zero-overhead tracking of read-set & write-set
 - Zero-overhead versioning
 - Fast commits & aborts without data movement
 - Continuous validation of read-set
- Strong isolation
 - Conflicts detected on non-transactional loads/stores as well

HTM Advantages

- Fast common-case behavior
 - Zero-overhead tracking of read-set & write-set
 - Zero-overhead versioning
 - Fast commits & aborts without data movement
 - Continuous validation of read-set
- Strong isolation
 - Conflicts detected on non-transactional loads/stores as well
- Simplifies multi-core coherence and consistency [Hammond'04, Ceze'07]
 - Recall: Sequential consistency hard to implement
 - How would you enforce SC using HTM?

HTM Challenges

- Performance pathologies: How to handle frequent contention?
 - Should HTM guarantee fairness/enforce priorities?
- Size limitations: What happens if read-set + write-set exceed size of cache?
- Virtualization, I/O, syscalls...

HTM Challenges

- Performance pathologies: How to handle frequent contention?
 - Should HTM guarantee fairness/enforce priorities?
- Size limitations: What happens if read-set + write-set exceed size of cache?
- Virtualization, I/O, syscalls...
- Hybrid TMs may get the best of both worlds:
 - Handle common case in HW, but with no guarantees
 - Abort on cache overflow, interrupt, syscall instruction, ...
 - On abort, code can revert to software TM
 - Current approach in Intel's RTM...
 - ... but still unclear how to integrate HTM & STM well
- Currently, slow/limited adoption by programmers, who must still support non-HTM systems